

30.5 Controlling External I/O in LT

30.5.1 Summary

The DIO with built-in LT supports special inputs and outputs in addition to standard I/O. These include High Speed Counter Input, Pulse Output, PWM Output, and Pulse Catch.

- High Speed Counter Input: Can receive a pulse up to 100KHz (up to 50KHz for 2-Phase counter).
- Pulse Output: Can output a pulse up to 65KHz.
- PWM Output: Can output a pulse up to 65KHz.
- Pulse Catch: Can detect a pulse at 100 KHz (on for more than 5 microseconds).

Where and how to allocate I/O terminals differs between the standard I/O and special I/O. Please refer to the following table.

Feature	Points	Remarks	Details	
Standard I/O				
Standard Input*1	LT-3200 Series	12	--	page 30-50
	LT-3300 Series	16	--	
Standard Output*1	LT-3200 Series	6	--	page 30-53
	LT-3300 Series	16	--	
Special I/O				
High Speed Counter (Single-phase counter)*1	4 CH	Measures single-phase input signals.	page 30-57	
Counter Control	--	Switches up/down.	page 30-57	
Preload Input	--	Changes the current value to an arbitrary value.	page 30-63	
Prestrobe Input	--	Memorizes the current count value.	page 30-69	
Synchronize output	--	Outputs when the count value is within the specified range.	page 30-74	
High Speed Counter (2-Phase Counter)*1	2 CH	Measures 2-phase input signals.	page 30-82	
Counter Control	--	Switches up/down.	page 30-57	
Phase Factor Mode	--	Specifies the measuring method.	page 30-86	
Preload Input	--	Changes the current value to an arbitrary value.	page 30-63	
Prestrobe Input	--	Memorizes the current count value.	page 30-69	
Synchronize output	--	Outputs when the count value is within the specified range.	page 30-74	
Marker Input	--	Clears the count value.	page 30-87	

Continued

Special I/O	PWM Output *1	4 CH	Outputs the output frequency pulse using the specified on duty.	page 30-89
	Normal Pulse Output *1	4 CH	Outputs the set frequency based on the set pulse value.	page 30-98
	Acceleration/Deceleration Pulse Output *1	4 CH	Increases the pulse to the set frequency for output.	page 30-106
	Pulse Catch Input *1	4 CH	Captures short pulses (more than 10s) and reports when they are captured.	page 30-122

*1 The same I/O terminals are used for standard input, standard output, PWM output, pulse output, high-speed counter. You cannot simultaneously use the maximum number of terminals for each input or output

30.5.2 Mapping I/O (Common)

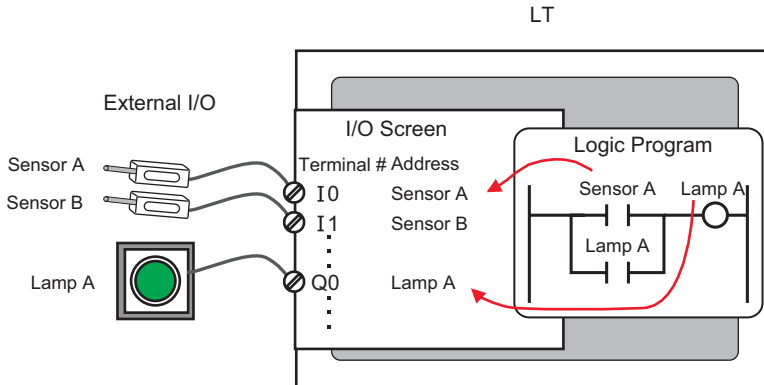

■ Terminal Structure

Different terminals are allocated for the standard I/O and for the special I/O (high-speed counter and PWM output, etc.).

Terminal for Standard Input: X8 to X11 (LT-3200 Series)
 X8 to X15 (LT-3300 Series)

Terminal for Standard Output: Y4 to Y5 (LT-3200 Series)
 Y4 to Y15 (LT-3300 Series)

Common terminal for the standard I/O and special I/O: X0 to X7, Y0 to Y3

LT-3200 Series

X11	X10	X9	X8	X7	X6	X5	X4	X3	X2	X1	X0
						Y5	Y4	Y3	Y2	Y1	Y0

I/O Terminal

LT-3300 Series

X15	X14	X13	X12	X11	X10	X9	X8	X7	X6	X5	X4	X3	X2	X1	X0
Y15	Y14	Y13	Y12	Y11	Y10	Y9	Y8	Y7	Y6	Y5	Y4	Y3	Y2	Y1	Y0

I/O Terminal

■ Setting the Standard I/O, High Speed Counter, PWM Output and Pulse Output

This section describes how to allocate the input terminals X0 to X7 and the output terminals Y0 to Y3. As shown below, divide these I/O terminals into four groups based on one channel (CH) consisting of two input terminals and one output terminal. Select the combination for each channel from those provided by GP-Pro EX.

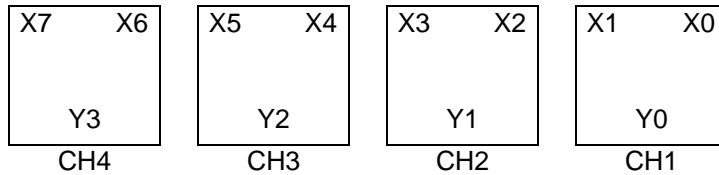

[GP-Pro EX I/O Driver Setting Screen]

Select [I/O Driver] in System Settings to display the following screen. For example, for the LT-3200 Series

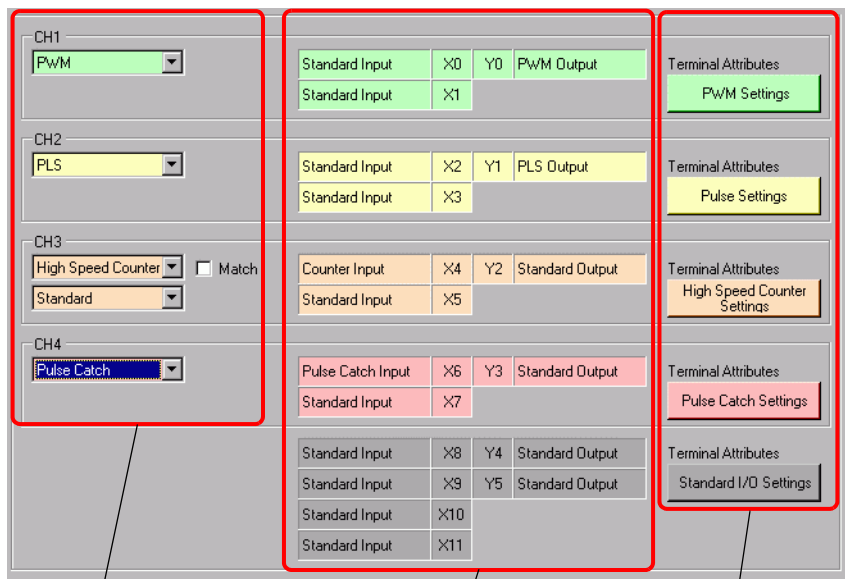

Sets the I/O pattern for each channel.

Displays I/O information mapped to each terminal according to the set pattern.

Click each button to display the dialog box for the default value and other detailed settings.

■ Combining Standard I/O and Special I/O

Depending on whether or not the high-speed counter (2-phase counter) is used, the combination differs as follows.

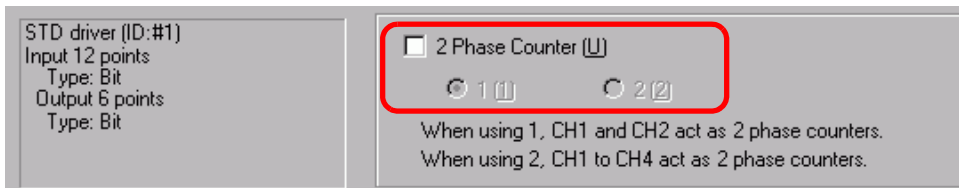

2-phase counter not used (CH1 to CH4)

There are ten setting patterns.

Setting Patterns	Input Terminal (n)	Input Terminal (n+1)	Output Terminal
Standard	Standard Input	Standard Input	Standard Output
PWM			PWM Output
PLS			PLS Output
High Speed Counter Standard Synchronize: Cleared	Counter Input	Standard Input	Standard Output
High Speed Counter Standard Synchronize: Selected			Synchronize output
High Speed Counter Preload Synchronize: Cleared		Preload Input	Standard Output
High Speed Counter Preload Synchronize: Selected			Synchronize output
High Speed Counter Prestrobe Synchronize: Cleared		Prestrobe Input	Standard Output
High Speed Counter Prestrobe Synchronize: Selected			Synchronize output
Pulse Catch		Pulse Catch Input	Standard Input

One 2-phase counter (CH1)

There are six setting patterns.

Setting Patterns	Input Terminal (n)	Input Terminal (n+1)	Output Terminal
Counter A (A phase) Standard Input Synchronize: Cleared	Counter A (A phase)	Standard Input	Standard Output
Counter A (A phase) Standard Input Synchronize: Selected			Synchronize output
Counter A (A phase) Preload Synchronize: Cleared		Preload Input	Standard Output
Counter A (A phase) Preload Synchronize: Selected			Synchronize output
Counter A (A phase) Prestrobe Synchronize: Cleared		Prestrobe Input	Standard Output
Counter A (A phase) Prestrobe Synchronize: Selected			Synchronize output

One 2-phase counter (CH2)

There are six setting patterns.

Setting Patterns	Input Terminal (n)	Input Terminal (n+1)	Output Terminal
Counter B (B phase) Marker Standard Output	Counter B (B phase)	Marker Input	Standard Output
Counter B (B phase) Marker PWM Output			PWM Output
Counter B (B phase) Marker PLS Output			PLS Output
Counter B (B phase) Standard Input Standard Output		Standard Input	Standard Output
Counter B (B phase) Standard Input PWM Output			PWM Output
Counter B (B phase) Standard Input PLS Output			PLS Output

- | | |
|-------------|---|
| NOTE | <ul style="list-style-type: none"> • CH3 and CH4 when one 2-Phase Counter is used are the same as CH1 to CH4 when 2-Phase Count is not used. |
|-------------|---|

Two 2-phase counters (CH1 and CH3)

There are six setting patterns.

Setting Patterns	Input Terminal (n)	Input Terminal (n+1)	Output Terminal
Counter A (A phase) Standard Input Synchronize: Cleared	Counter A (A phase)	Standard Input	Standard Output
Counter A (A phase) Standard Input Synchronize: Selected			Synchronize output
Counter A (A phase) Preload Synchronize: Cleared		Preload Input	Standard Output
Counter A (A phase) Preload Synchronize: Selected			Synchronize output
Counter A (A phase) Prestrobe Synchronize: Cleared		Prestrobe Input	Standard Output
Counter A (A phase) Prestrobe Synchronize: Selected			Synchronize output

Two 2-phase counters (CH2 and CH4)

There are six setting patterns.

Setting Patterns	Input Terminal (n)	Input Terminal (n+1)	Output Terminal
Counter B (B phase) Marker Standard Output	Counter B (B phase)	Marker Input	Standard Output
Counter B (B phase) Marker PWM Output			PWM Output
Counter B (B phase) Marker PLS Output			PLS Output
Counter B (B phase) Standard Input Standard Output		Standard Input	Standard Output
Counter B (B phase) Standard Input PWM Output			PWM Output
Counter B (B phase) Standard Input PLS Output			PLS Output

■ Special I/O System Variables

Once all the terminals are mapped in the [I/O Driver], map the standard I/O terminals in the [I/O screen]. Please note that terminals allocated to special I/O are mapped to system variables (integer format) for storing its unique information.

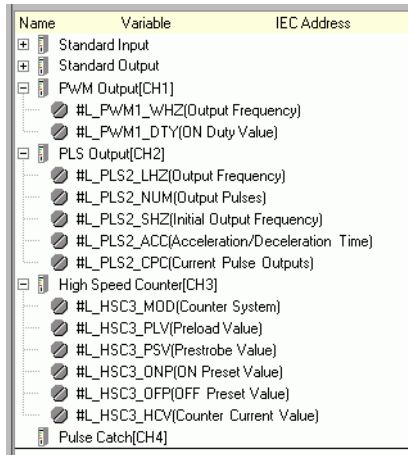

System variable details.

System Variable	Description	Always	High Speed Counter	PWM Output	Pulse output	Pulse Catch
#L_ExIOFirmVer	Extended I/O port firmware version	○				
#L_ExIOSpCtrl	Special I/O control		○	○	○	○
#L_ExIOSpOut	Special Output		○	○	○	
#L_ExIOSpParmChg	Change Special I/O parameter		○	○	○	
#L_ExIOSpParmErr	Special I/O parameter error		○	○	○	
#L_ExIOAccelPlsTbl	Acceleration/Deceleration pulse table				○	
#L_ExIOCntInCtrl	Counter input control		○			
#L_ExIOCntInExtCtrl	Counter external input control		○			
#L_PWM*_WHZ	CH* Output Frequency			○		
#L_PWM*_DTY	CH* ON duty value			○		
#L_PLS*_LHZ	CH* Output Frequency				○	
#L_PLS*_NUM	CH* Output pulse count				○	
#L_PLS*_SHZ	CH* Initial Output Frequency				○	
#L_PLS*_ACC	CH* Acceleration/Deceleration time				○	
#L_PLS*_CPC	CH* Current Pulse Output Value				○	
#L_HSC*_MOD	CH* Count Method		○			
#L_HSC*_PLV	CH* Preload Value		○			
#L_HSC*_PSV	CH* Prestrobe Value		○			
#L_HSC*_ONP	CH* ON Preset Value		○			
#L_HSC*_OFFP	CH* OFF Preset Value		○			
#L_HSC*_HCV	CH* Current Counter Value		○			

◆ **Extended I/O board firmware version (#L_ExIOFirmVer)**

H	0	0	0	0	0	0	0	0	0	0	0	0	0	0	0	0
L	Extended I/O port firmware version															

In the bottom 16 bits, stores the extended I/O board firmware version.
 For "Revision 01.05," store as "0x0105."

◆ **Special I/O control (#L_ExIOSpCtrl)**

H	CH4 Special I/O state	CH3 Special I/O state	CH2 Special I/O state	CH1 Special I/O state
L	CH4 Special I/O control	CH3 Special I/O control	CH2 Special I/O control	CH1 Special I/O control

Special I/O control

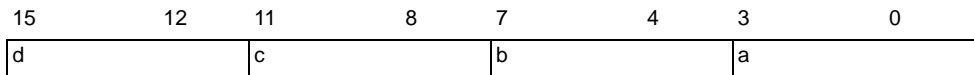

This variable uses the CH specified in the I/O driver settings as the 4-bit configuration information to control the special I/O operation.

- a: CH1 special I/O control c: CH3 special I/O control
- b: CH2 special I/O control d: CH4 special I/O control

PWM Output

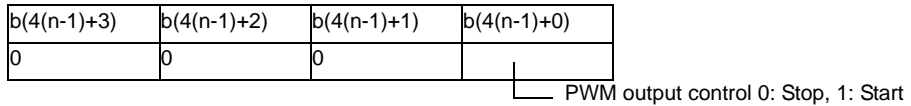

Pulse output

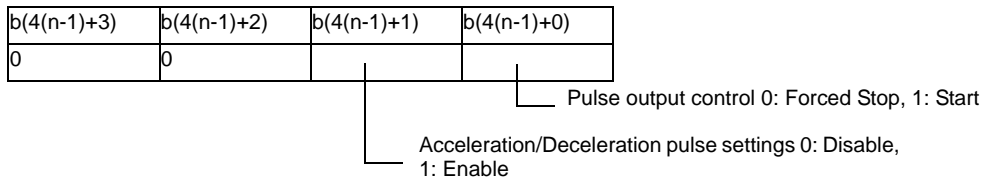

High speed counter (including 2-phase counter)

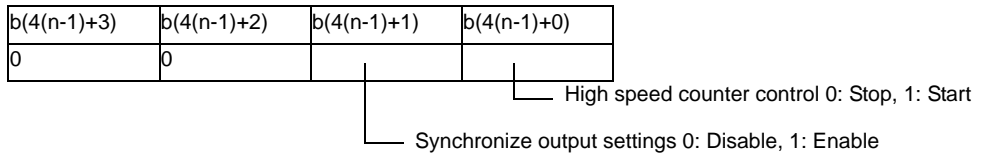

Pulse Catch

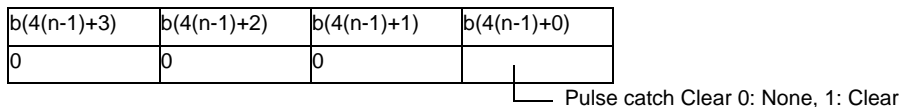

*When applying a CH number to "n", the applicable bit number "b" can be found.

Special I/O state

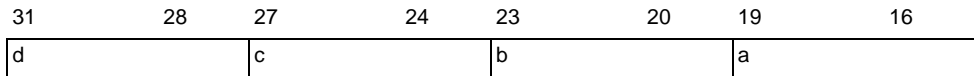

This variable uses the CH specified in the I/O driver settings as the 4-bit configuration information to show the special I/O state.

- a: CH1 special I/O state c: CH3 special I/O state
- b: CH2 special I/O state d: CH4 special I/O state

PWM Output

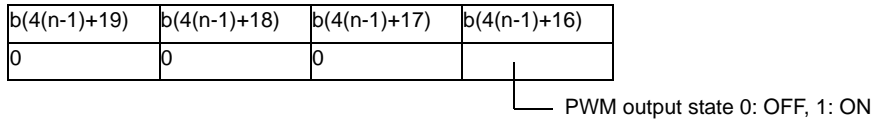

Pulse output

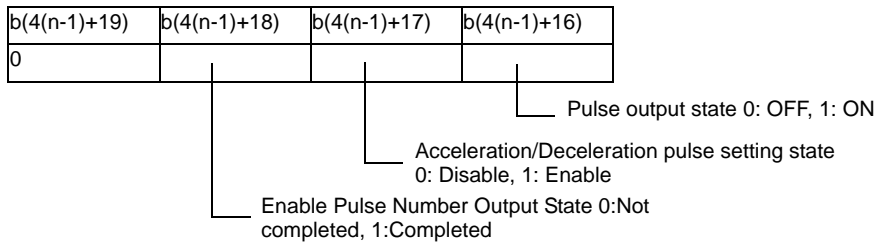

High speed counter (including 2-phase counter)

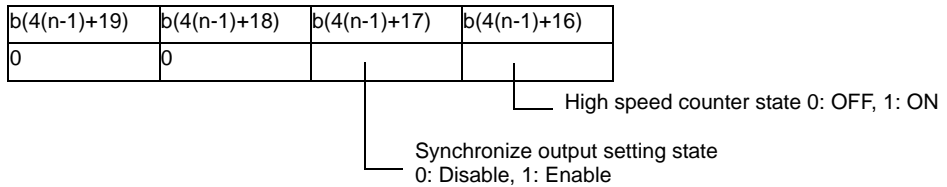

Pulse Catch

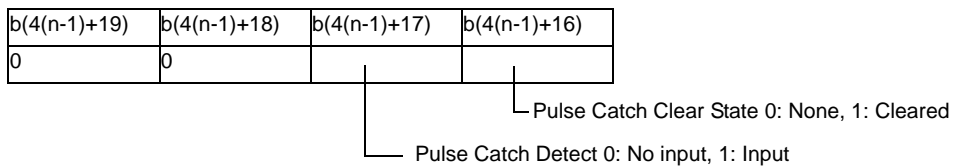

*When applying a CH number to "n", the applicable bit number "b" can be found.

◆ **Special I/O output (#L_ExIOSpOut)**

H	0	0	0	0	0	0	0	0	0	0	0	0	0	0	0	0
L	CH4 information				CH3 information				CH2 information				CH1 information			
	15	12	11	8	7	4	3	0								
	d				c				b				a			

This variable uses the CH specified in the I/O driver settings as the 4-bit configuration information to show the special I/O output state.

- a: CH1 special I/O output state c: CH3 special I/O output state
- b: CH2 special I/O output state d: CH4 special I/O output state

$b(4(n-1)+3)$	$b(4(n-1)+2)$	$b(4(n-1)+1)$	$b(4(n-1)+0)$
0	0	0	

Special I/O Output State 0: OFF, 1: ON

*When applying a CH number to "n", the applicable bit number "b" can be found.

◆ **Special I/O parameter change (#L_ExIOSpParmChg)**

H	CH4 Special I/O parameter Changed successfully	CH3 Special I/O parameter Changed successfully	CH2 Special I/O parameter Changed successfully	CH1 Special I/O parameter Changed successfully
L	CH4 Special I/O parameter Change request	CH3 Special I/O parameter Change request	CH2 Special I/O parameter Change request	CH1 Special I/O parameter Change request

Request Special I/O Parameter Change

15	12	11	8	7	4	3	0								
d				c				b				a			

This variable uses the CH specified in the I/O driver settings as the 4-bit configuration information to request the special I/O parameter change.

- a: CH1 special I/O parameter change request
- b: CH2 special I/O parameter change request
- c: CH3 special I/O parameter change request
- d: CH4 special I/O parameter change request

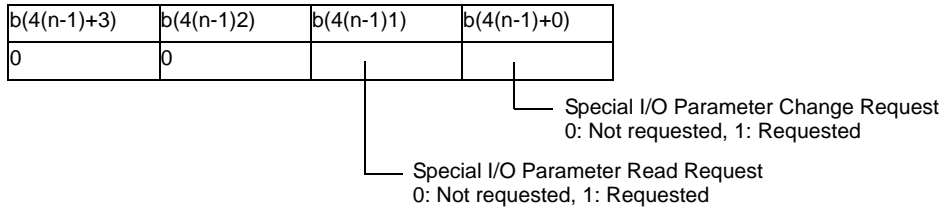

- * Change the parameter before turning the bit on for the special I/O parameter change request.
- * You cannot change the parameter for the acceleration/deceleration pulse here. Use a table creation request flag for the acceleration/deceleration pulse.
- * When reading the parameter of the acceleration/deceleration pulse, turn on the flag for the acceleration/deceleration pulse to control the special I/O operation.
- * When applying a CH number to "n", the applicable bit number "b" can be found.

Special I/O parameter change completed

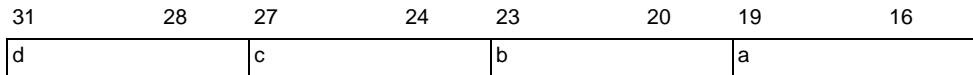

This variable uses the CH specified in the I/O driver settings as the 4-bit configuration information to notify the completion of the special I/O parameter change.

- a: CH1 special I/O parameter changed successfully
- b: CH2 special I/O parameter changed successfully
- c: CH3 special I/O parameter changed successfully
- d: CH4 special I/O parameter changed successfully

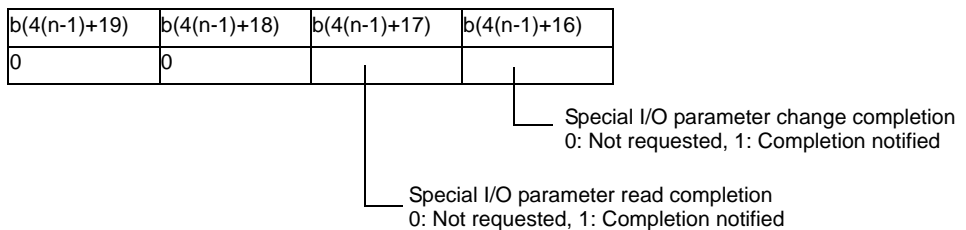

*When applying a CH number to "n", the applicable bit number "b" can be found.

◆ Special I/O parameter error (#L_ExIOSpParmErr)

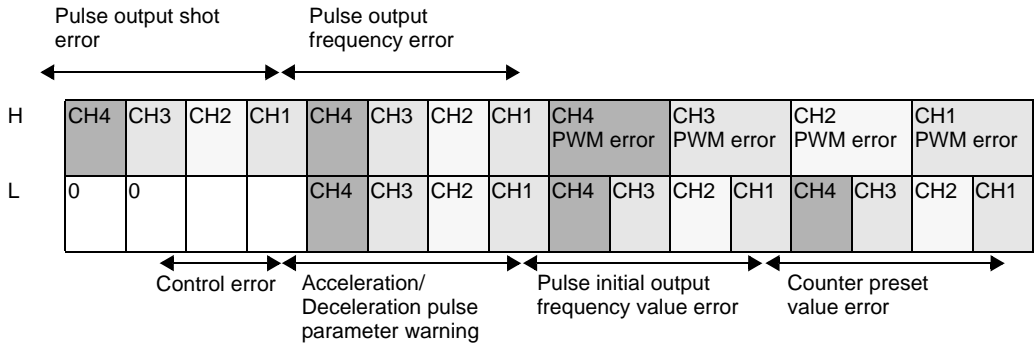

The applicable bit turns ON if there is an error when the parameter changes to a special I/O parameter.

PWM error

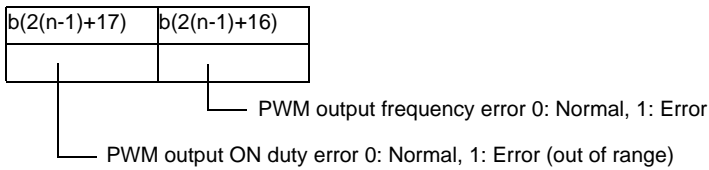

*When applying a CH number to "n", the applicable bit number "b" can be found.

Pulse output frequency error

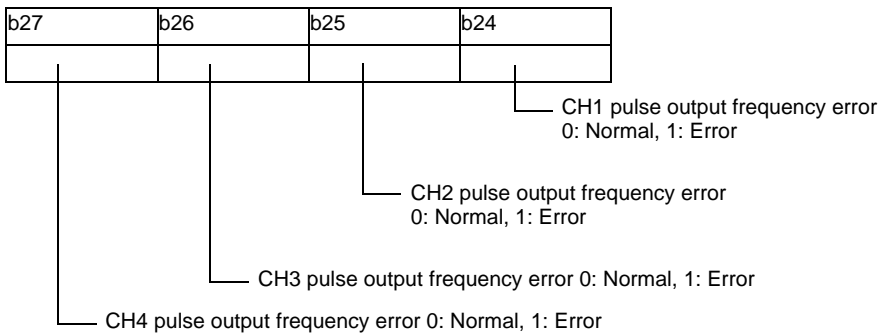

Pulse output shot error

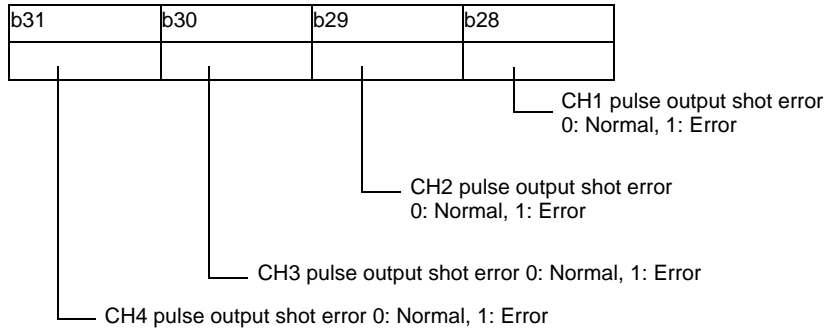

Counter preset value error

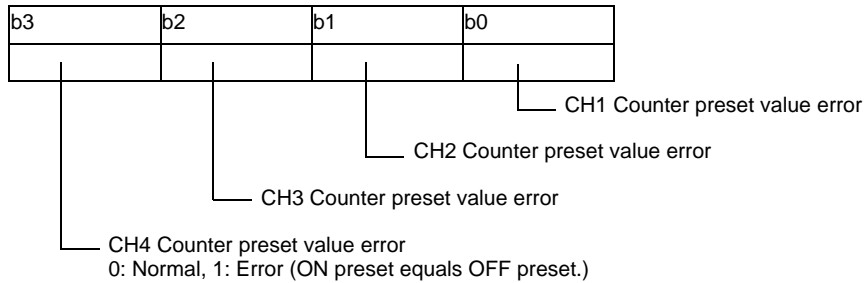

Pulse initial output frequency value error

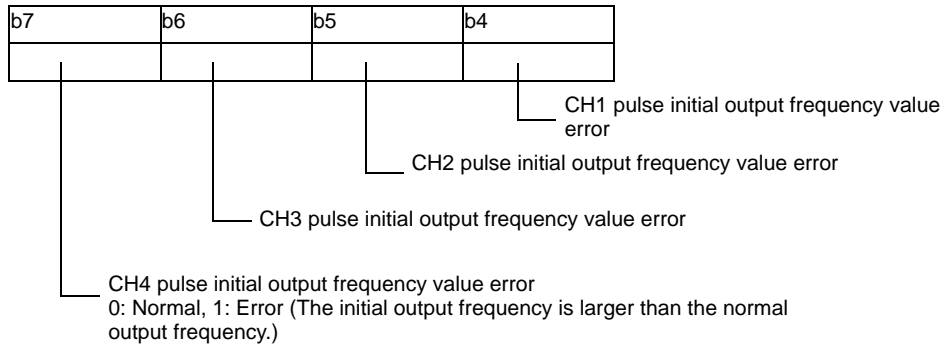

Acceleration/Deceleration pulse parameter warning

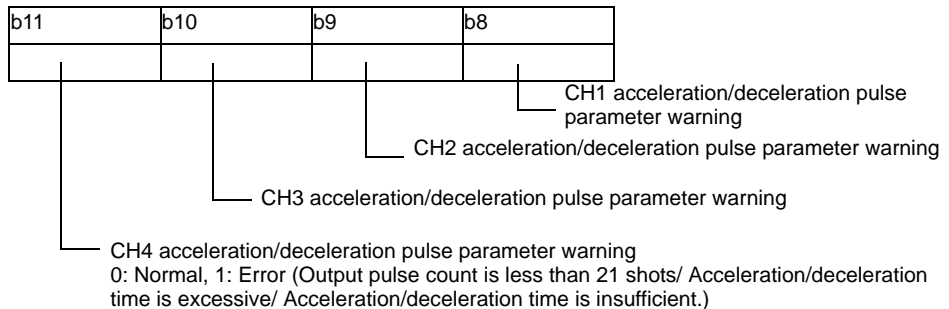

Control error

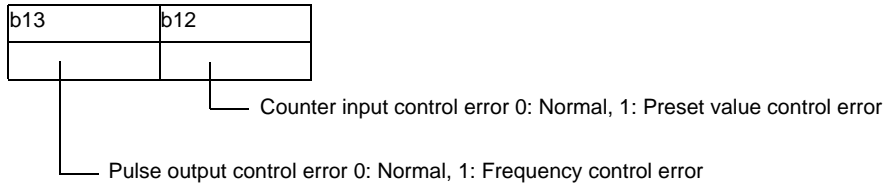

- * Counter input control error occurs when the bottom 16 bits in the ON Preset Value or OFF Preset Value is xxxxFFFFh or xxxx0000h.
 - * The pulse output control error occurs when the total of the Counter Input condition check time and Pulse Output condition check time exceed the minimum width for the Pulse Output.
- For more information, see "30.5.14 Restrictions" (page 30-129).

◆ Acceleration/Deceleration pulse table (#L_ExIOAccelPIsTbl)

H	0	0	0	0	CH4 Table Created successfully	CH3 Table Created successfully	CH2 Table Created successfully	CH1 Table Created successfully	0	0	0	0
L	0	0	0	0	CH4 Table Creation requested	CH3 Table Creation requested	CH2 Table Creation requested	CH1 Table Creation requested	0	0	0	0

Request for the acceleration/deceleration pulse table creation

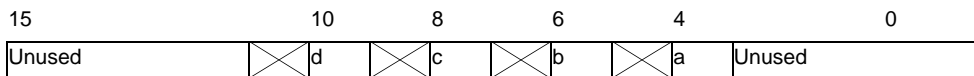

- a: CH1 acceleration/deceleration pulse table creation request 0: Not requested, 1: Requested
- b: CH2 acceleration/deceleration pulse table creation request 0: Not requested, 1: Requested
- c: CH3 acceleration/deceleration pulse table creation request 0: Not requested, 1: Requested
- d: CH4 acceleration/deceleration pulse table creation request 0: Not requested, 1: Requested

The Create Acceleration/Deceleration table complete successfully

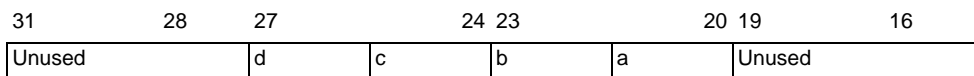

- a: CH1 acceleration/ deceleration pulse table created successfully
- b: CH2 acceleration/ deceleration pulse table created successfully
- c: CH3 acceleration/ deceleration pulse table created successfully
- d: CH4 acceleration/ deceleration pulse table created successfully

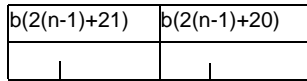

The completion of acceleration/deceleration pulse table creation
 0: Normal, 1: Created successfully
 Acceleration/Deceleration pulse table
 0: None, 1: Enable (table available for output)

* When applying a CH number to "n", the applicable bit number "b" can be found.

◆ Counter Input Control (#L_ExIOCntInCtrl)

H	CH4 Counter Input Control response	CH3 Counter Input Control response	CH2 Counter Input Control response	CH1 Counter Input Control response
L	CH4 Counter Input Control request	CH3 Counter Input Control request	CH2 Counter Input Control request	CH1 Counter Input Control request

Control request for counter input only

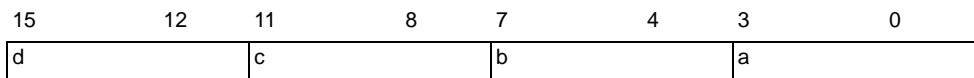

This variable uses the CH specified in the I/O driver settings as the 4-bit configuration information to request the counter input control.

- a: CH1 counter input control request
- b: CH2 counter input control request
- c: CH3 counter input control request
- d: CH4 counter input control request

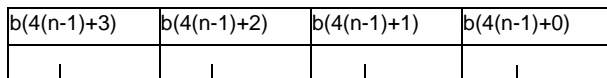

Counter value clear request
 0: Not requested, 1: Requested (counter value is cleared with 0)
 Synchronize output clear request
 0: Not requested, 1: Requested (synchronize output OFF)
 Preload rewrite request
 0: Not requested, 1: Requested (counter value is rewritten with the preset value)
 Prestrobe read request
 0: Not requested, 1: Requested (counter value reads as the prestrobe variable)

* When applying a CH number to "n", the applicable bit number "b" can be found.

Counter input control response

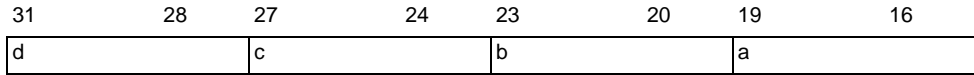

This variable uses the CH specified in the I/O driver settings as the 4-bit configuration information to store the counter input control response.

- a: CH1 counter input control response
- b: CH2 counter input control response
- c: CH3 counter input control response
- d: CH4 counter input control response

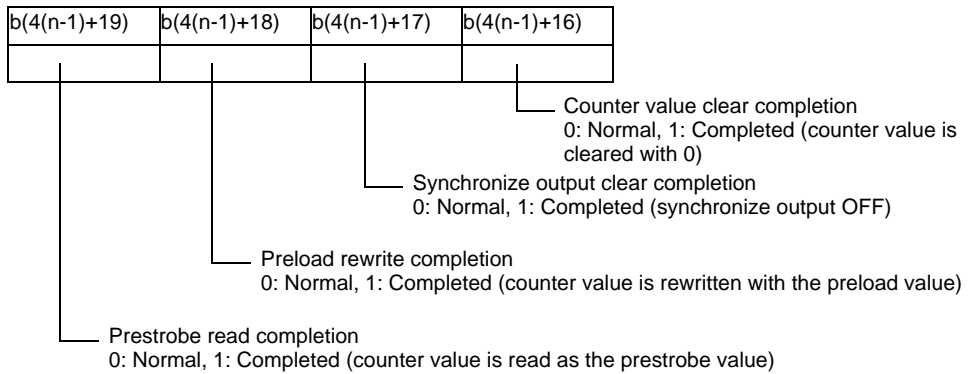

* When applying a CH number to "n", the applicable bit number "b" can be found.

◆ Counter External Input Control (#L_ExIOCntInExtCtrl)

H	CH4 Counter external input Completion acknowledgment	CH3 Counter external input Completion acknowledgment	CH2 Counter external input Completion acknowledgment	CH1 Counter external input Completion acknowledgment
L	CH4 Counter external input Completed	CH3 Counter external input Completed	CH2 Counter external input Completed	CH1 Counter external input Completed

Counter external input completed

The counter external input (preload/prestrobe input/marker input*1) turns ON and notifies you that the counter value overwrite or read has completed successfully.

15	12	11	9	8	7	4	3	1	0
Unused	f	Unused	e	d	Unused	c	Unused	b	a

- a: CH1 preload/prestrobe completed 0: Normal, 1: Completed
- b: Marker Input *1 for 2-Phase Counter Input of CH1 completed 0: Normal, 1: Completed
- c: CH2 preload/prestrobe completed 0: Normal, 1: Completed
- d: CH3 preload/prestrobe completed 0: Normal, 1: Completed
- e: CH3 2-phase counter input marker input completed 0: Normal, 1: Completed
- f: CH4 preload/prestrobe completed 0: Normal, 1: Completed

Acknowledge counter external input completed

Use this variable when confirming that the counter external input (preload/prestrobe input/marker input *1) is complete.

31	28	27	25	24	23	20	19	17	16
Unused	f	Unused	e	d	Unused	c	Unused	b	a

- a: CH1 preload/prestrobe completion acknowledgment 0: Normal, 1: Acknowledged
- b: Marker Input *1 for 2-Phase Counter of CH1 completion acknowledgment 0: Normal, 1: Acknowledged
- c: CH2 preload/prestrobe completion acknowledgment 0: Normal, 1: Acknowledged
- d: CH3 preload/prestrobe completion acknowledgment 0: Normal, 1: Acknowledged
- e: CH3 2-phase counter input marker input completion acknowledged 0: Normal, 1: Completed
- f: CH4 preload/prestrobe completion acknowledgment 0: Normal, 1: Acknowledged

*1 Marker input is only for using 2-phase counter

◆ **CH* output frequency (#L_PWM*_WHZ)**

H	Stores the PWM* output frequency. Initial value: 10 (Hz) Range: 10 to 65000
L	

◆ **CH* ON duty value (#L_PWM*_DTY)**

H	Stores the PWM* DUTY value. Initial value: Range: 0 to 100
L	

◆ **CH* output frequency (#L_PLS*_LHZ)**

H	Stores the PLS* output frequency. Initial value: 10 (Hz) Range: 10 to 65000
L	

◆ **CH*Output pulse count (#L_PLS*_NUM)**

H	Stores the PLS* Output pulse count. Initial value: 0 (pulse) Range: 0 to 2147483647
L	

◆ **CH* initial output frequency (#L_PLS*_SHZ)**

H	Stores the initial PLS* output frequencies. Initial value: 10 (Hz) Range: 10 to 65000
L	

◆ **CH* acceleration/deceleration time (#L_PLS*_ACC)**

H	Stores the PLS* acceleration/deceleration time. Initial value: 0 (milliseconds) Range: 0 to 65535
L	

◆ **CH* pulse output current value (#L_PLS*_CPC)**

H	Stores the current PLS* pulse output value. Initial value: - Value range: 0 to 2147483647
L	

◆ **CH* count method (#L_HSC*_MOD)**

H	0	0	0	0	0	0	0	0	0	0	0	0	0	0	0
L	0	0	0	0	0	0	0	0	0	0	0	0	HSC method		

HSC method

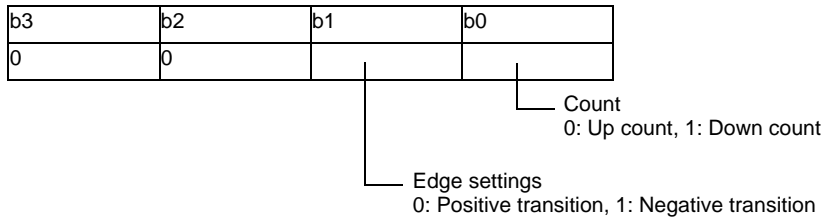

◆ **CH* preload value (#L_HSC*_PLV)**

H	Stores the HSC* preload value. Default: 0 Range: -2147483648 to 2147483647
L	

◆ **CH* prestrobe value (#L_HSC*_PSV)**

H	Stores the HSC* prestrobe value. Initial value: - Range: -2147483648 to 2147483647
L	

◆ **CH* ON preset value (#L_HSC*_ONP)**

H	Stores the HSC* ON preset value. Initial Value: -2147483647 Value range: -2147483647 to 2147483646
L	

◆ **CH* OFF preset value (#L_HSC*_OFF)**

H	Stores the HSC* OFF preset value. Default: 2147483646 Value range: -2147483647 to 2147483646
L	

◆ **CH* counter current value (#L_HSC*_HCV)**

H	Stores the current HSC* counter value. Initial value: - Value range: -2147483648 to 2147483647
L	

30.5.3 Interface Specification

The I/O board sends the control order from the LT as shown in the following chart to control various I/Os. All orders and information on the I/O board are sent and received in I/F RAM.

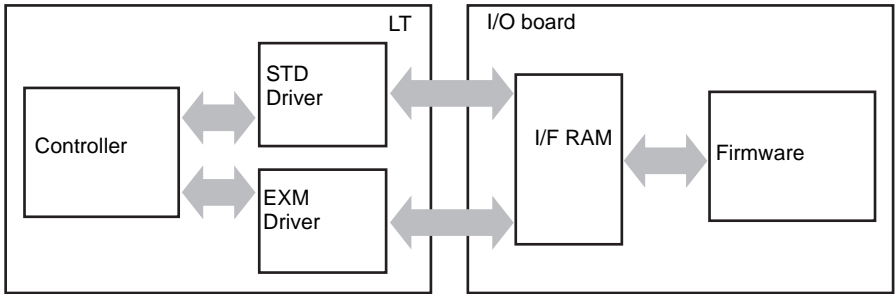

◆ I/O board processing

I/O board processing is mainly for refreshing I/O data and controlling the special I/O upon the LT request. These are processed via special I/O interrupt processing, 0.5 milliseconds fixed-cycle processing, 2 milliseconds fixed-cycle processing, and always-on processing. The priority of processing follows the order of special I/O interrupt processing, 0.5 milliseconds fixed-cycle processing, 2 milliseconds fixed-cycle processing, and then always-on processing.

For example, to execute special I/O interrupt processing while 2 milliseconds-fixed processing is being executed, 2 milliseconds fixed-cycle processing is stopped in order to execute special I/O interrupt processing.

Processing	Items	Details
Special I/O interrupt	Special I/O unique processing	(Counter synchronize output control)
		(Counter preload input processing)
		(Counter strobe input processing)
		(2-phase counter marker input processing)
		(Acceleration/Deceleration pulse table switching)
0.5 millisecond fixed-cycle	Input terminal state storing	
2 millisecond fixed-cycle	Standard I/O refresh	
	Special I/O control watch	Special I/O start/stop
	Special I/O parameter change watch	Various special I/O parameter change

Continued

2 millisecond fixed-cycle	(Special I/O counter input request watch)	(Counter value clear)
		(Synchronize output clear)
		(Counter value read)
		(Counter value write)
	Special I/O unique processing	Output pulse count update
	Existing host watch	
Normal Scanning (Always-on)	Control register watch	STD driver <ul style="list-style-type: none"> • Various input settings change • Special I/O settings change • Acceleration/Deceleration pulse table creation
	Communicating with EXM modules	

◆ **To execute the processing for standard I/O only**

The following is a reference that describes the transition of each process.

For convenience, each process uses the same processing time.

For Standard I/O, there is nothing that causes processing time to fluctuate.

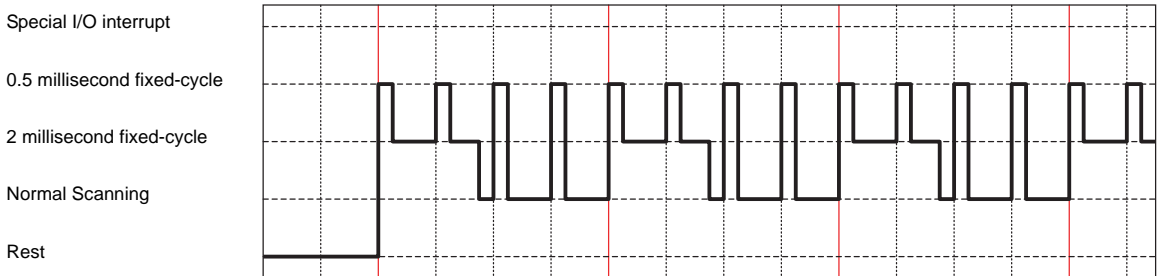

◆ **To use special I/O**

When you change the parameter while executing special I/O, the processing time of 2 milliseconds fixed-cycle changes. If the processing time of 2 milliseconds fixed-cycle increases, it affects the normal scan time and consequently the normal scan time increase.

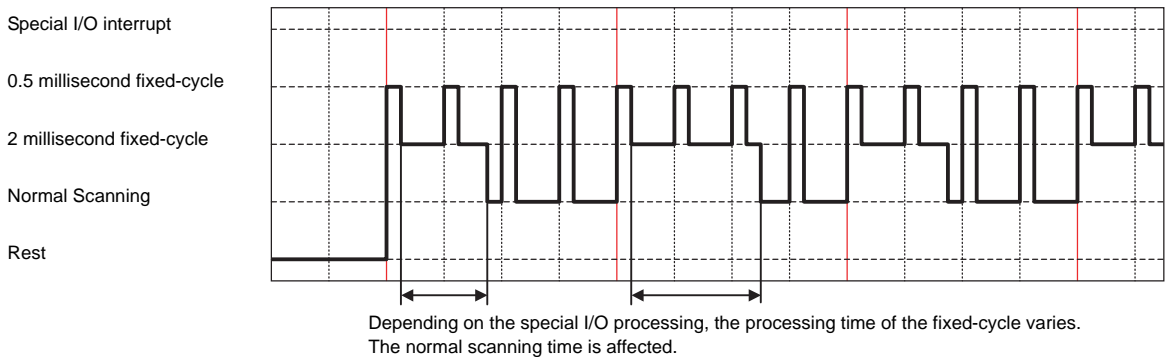

◆ **Interrupt processing**

When using special I/O that interrupts other processing, you can execute the special I/O interrupt processing at any time. Since the special I/O interrupt processing affects all other processing time, those processing times also increase.

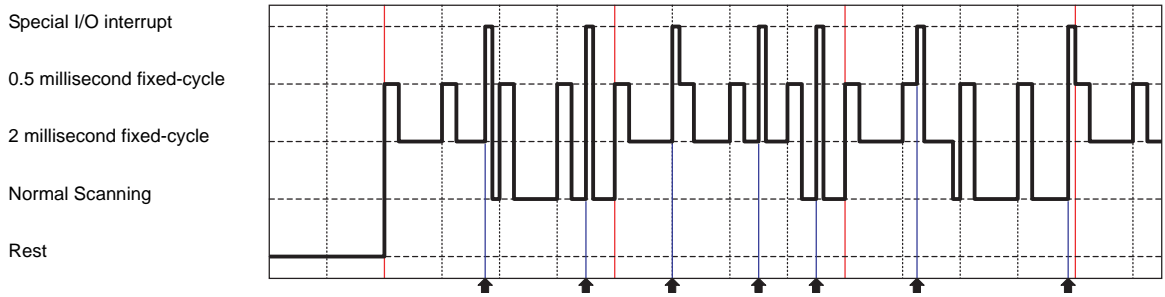

The special I/O processing affects the processing time of 0.5 milliseconds fixed-cycle and the normal scanning time.

30.5.4 Standard Input

The microcomputer on the I/O board watches the input terminal state at 0.5 millisecond-loop updates and writes the input state to the I/F RAM when I/O is refreshed every 2 millisecond-loop update.

When the digital input filter is set, data for sampling set at the time of I/O refreshing is tracked back, and the result is written in I/F RAM. The value written in I/F RAM is read per scanning time of LT.

When [Word] is selected for [Type] in the [Standard I/O Settings] dialog box, for 32-bit variables allocated to I/O, the lower 12 bits are used for the LT-3200 Series while the lower 16 bits are used for the LT-3300 Series.

Do not use unused areas of allocated variables (fix to 0). If a value is updated for an unused area (for example, at 20 bit), it is cleared at the time of the next scan.

■ Digital Input Filter

The digital input filter is a feature that eliminates noise from input signals like software. For the digital input filter, the minimum is 0.5 millisecond and you can use up to 20 milliseconds in 0.5 millisecond-units.

Once the digital input filter is set, it stores data sampled at 0.5 millisecond-loop updates and reads the input terminal state before the set time when I/O is refreshed every 2 millisecond-loop update, and then compares the data.

If all the input terminal states show the same state, use the state as the input terminal value. If not, use the previous value. (If the number of data does not reach the sufficient level within the filtering time, select the input state OFF when the digital input filter is set.)

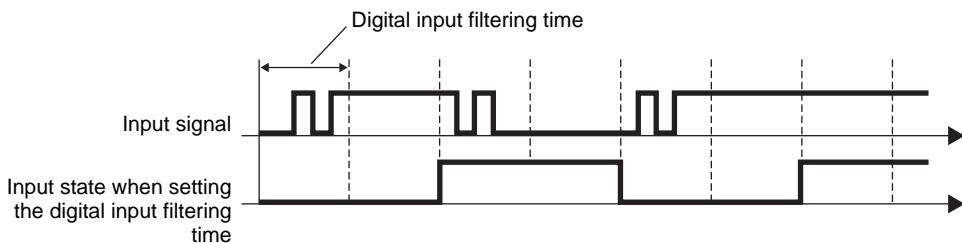

IMPORTANT

- Based on the output characteristics and noise from the device you are connecting to, set the digital input filtering time.
- If special I/O is selected in the CH terminal settings, you cannot use the CH input terminals for standard input.
- For information about delays caused by the hardware, see "30.5.14 Restrictions" (page 30-129).

■ **Setup Procedure**

1 In [System Settings], select [I/O Driver] and click [Standard I/O Settings] on the [Internal Driver 1] screen.

For the LT-3200 Series

Standard Input	X8	Y4	Standard Output	Terminal Attributes Standard I/O Settings
Standard Input	X9	Y5	Standard Output	
Standard Input	X10			
Standard Input	X11			

For the LT-3300 Series

Standard Input	X8	Y4	Standard Output	Terminal Attributes Standard I/O Settings
Standard Input	X9	Y5	Standard Output	
Standard Input	X10	Y6	Standard Output	
Standard Input	X11	Y7	Standard Output	
Standard Input	X12	Y8	Standard Output	
Standard Input	X13	Y9	Standard Output	
Standard Input	X14	Y10	Standard Output	
Standard Input	X15	Y11	Standard Output	
		Y12	Standard Output	
		Y13	Standard Output	
		Y14	Standard Output	
		Y15	Standard Output	

2 The [Standard I/O Settings] dialog box appears. Input filtering time range is from 0 milliseconds to 20 milliseconds in 0.5 millisecond unit.

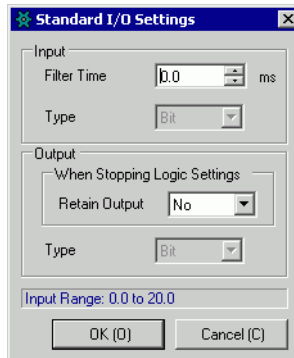

NOTE

- A setting of 0 milliseconds disables the digital input filter.
- When CH1 to CH4 are all set to "Standard", [Type] can be set to "Bit" or "Word".

IMPORTANT

- When either Input or Output [Type] is set to "Word", Special I/O cannot be selected in CH1 to CH4. When setting Special I/O, set all [Type] to "Bit".
- Be careful when changing [Type] while I/O is already allocated. I/O mapping may be canceled, or errors may occur when saving or transferring.

☞ " ◆ Cautions When Changing Types" (page 30-52)

◆ **Cautions When Changing Types**

- When changing from bit-type to word-type, if I/O has been allocated to I0-I11 and Q0-Q5 in the LT-3200 Series, and also to I0-I15 and Q0-Q15 in the LT-3300 Series, the allocation of I/O will be cancelled. In addition, variables allocated to I0 and Q0 are directly allocated to IW0 and QW0. However, because bit variables are allocated to word-type I/O, an error will occur during error checking when saving and transferring.
- Similarly, when word-type is changed to bit-type, variables allocated to IW0 and QW0 are directly allocated to I0 and Q0. However, because word variables are allocated to I/O of bit type, an error occurs during error checking when saving and transferring.

30.5.5 Standard Output

The Standard Output feature writes the output data from the STD driver to the I/F RAM every LT scan time. Then, the I/O board reads the output specified area every 2 millisecond-loop update. The read value is reflected to the output terminal on the I/O board.

Use the standard output function to choose whether or not to save the output state when the logic program stops.

When [Word] is selected for [Type] in the [Standard I/O Settings] dialog box, for 32-bit variables allocated to I/O, the lower 6 bits are used for the LT-3200 Series while the lower 16 bits are used for the LT-3300 Series.

Do not use unused areas of allocated variables (fix to 0). If a value is updated for an unused area (for example, at 20 bit), it does not affect other output. Furthermore, the value remains the same and is not cleared.

■ Saving Output When Logic Stops

This feature saves the output state in the standard output when the logic program stops. When the logic program is restarted, the state returns to the allocated variable.

Furthermore, when you switch to off-line, reset, or turn OFF the power, I/O is initialized and the saved output become ALL OFF.

IMPORTANT

- All terminals use the same output saving settings when the logic stops.
- If you select special I/O in the CH terminal settings, you cannot use the CH output terminal for standard output.

■ Setup Procedure

- 1 In [System Settings], select [I/O Driver] and click [Standard I/O Settings] on the [Internal Driver 1] screen.

For the LT-3200 Series

Standard Input	X8	Y4	Standard Output	Terminal Attributes
Standard Input	X9	Y5	Standard Output	Standard I/O Settings
Standard Input	X10			
Standard Input	X11			

For the LT-3300 Series

Standard Input	X8	Y4	Standard Output	Terminal Attributes
Standard Input	X9	Y5	Standard Output	Standard I/O Settings
Standard Input	X10	Y6	Standard Output	
Standard Input	X11	Y7	Standard Output	
Standard Input	X12	Y8	Standard Output	
Standard Input	X13	Y9	Standard Output	
Standard Input	X14	Y10	Standard Output	
Standard Input	X15	Y11	Standard Output	
		Y12	Standard Output	
		Y13	Standard Output	
		Y14	Standard Output	
		Y15	Standard Output	

2 The [Standard I/O Settings] dialog box appears. Define the [Retain Output] setting.

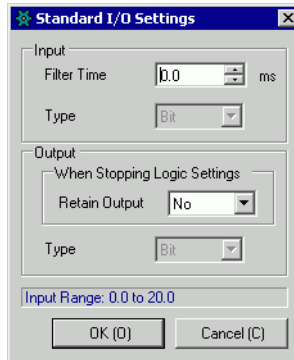

NOTE

- When CH1 to CH4 are all set to "Standard", [Type] can be set to "Bit" or "Word".
-

IMPORTANT

- When either Input or Output [Type] is set to "Word", Special I/O cannot be selected in CH1 to CH4. When setting Special I/O, set all [Type] to "Bit".
 - Be careful when changing [Type] while I/O is already allocated. I/O mapping may be canceled, or errors may occur when saving or transferring.
- ☞ " ◆ Cautions When Changing Types" (page 30-52)
-

30.5.6 High Speed Counter (Common)

The high-speed counter can count the CH maximum pulse signal of 100kHz starting from – 2147483648 to 2147483647 (32 bits).

Some high-speed counters are single-phase counter that has one input terminal and other are 2-phase counters that have two input terminals. Depending on the counter type, the relevant features and terminal number. to allocate differ as shown below.

For more information on the single-phase counter and 2-phase counter, please see below.

☞ "30.5.7 High Speed Counter (Single-phase Settings)" (page 30-57)

☞ "30.5.8 High speed counter (2-phase settings)" (page 30-82)

■ Summary of Supported Features

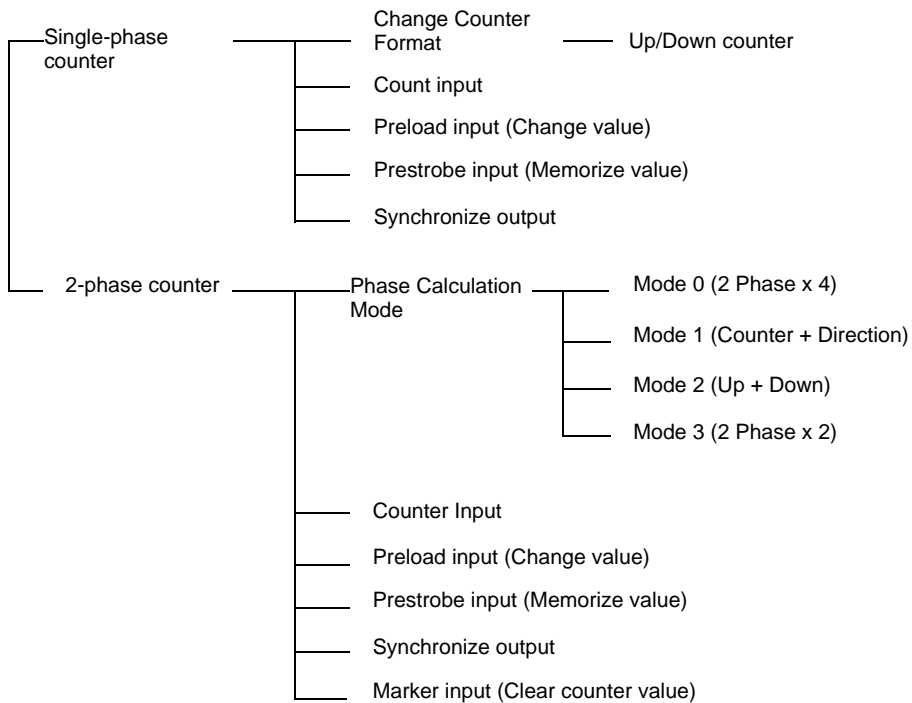

NOTE • For the terminal numbers available, see the following.
 ☞ "30.5.2 Mapping I/O (Common)" (page 30-27)

■ Retaining Counter Value and Retaining Matching Output when the Logic Stops

This function saves the current counter value and the output state when the logic program stops. Once the logic program restarts, operations begin with the saved values. If you go offline, reset, or turn OFF the power, the retained counter value is reset.

◆ Setup Procedure

- 1 In [System Settings], select [I/O Driver] and click [High Speed Counter Settings] on the [Internal Driver 1] screen.

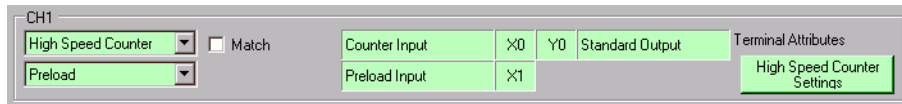

- 2 The [High Speed Counter Setting] dialog box appears. In [When Stopping Logic Settings], select OK in the Save Counter Value drop-down menu then click [OK].

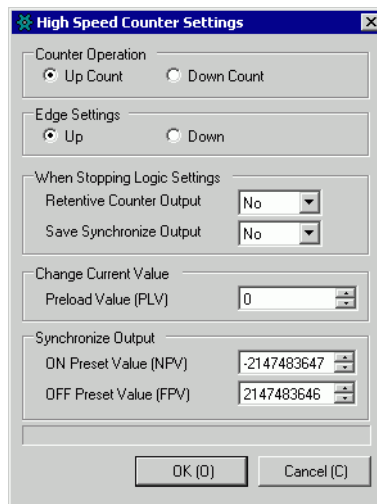









30.5.7 High Speed Counter (Single-phase Settings)

The single-phase counter is a counter that has one input terminal and measures single-phase input signals. You can use up to four single-phase counters.

The main functions of the single phase counter are indicated in the following table.

NOTE

- Some of the settings can be configured in the logic program's I/O driver instructions.
 "31.24 I/O Driver Instructions" (page 31-575)

Summary of functions	Browse to
Switches the up/down count	 "30.5.7 High Speed Counter (Single-phase Settings) ■ Switching Counting System" (page 30-57)
Starts and stops the high-speed counter	 "30.5.7 High Speed Counter (Single-phase Settings) ■ Controlling High Speed Counter Action" (page 30-61)
Checks the start and stop status of the high-speed counter	 "30.5.7 High Speed Counter (Single-phase Settings) ■ High Speed Counter Action Status" (page 30-61)
Clears the current counter value	 "30.5.7 High Speed Counter (Single-phase Settings) ■ Function to Clear the Current Counter Value" (page 30-61)
Rewrites the current counter value	 "30.5.7 High Speed Counter (Single-phase Settings) ■ Preload (Change value)" (page 30-63)
Stores the current counter value (read)	 "30.5.7 High Speed Counter (Single-phase Settings) ■ Prestrobe (Current Value Memory)" (page 30-69)
Outputs the current counter value when it exceeds the specified value	 "30.5.7 High Speed Counter (Single-phase Settings) ■ Synchronize Output" (page 30-74)
Save the counter value when the logic stops	 "30.5.6 High Speed Counter (Common) ■ Retaining Counter Value and Retaining Matching Output when the Logic Stops" (page 30-56)

■ Switching Counting System

The counting system can be changed from up-counter to down-counter, or from down-counter to up-counter while counting. Switching counting can be set per CH for which you allocate the counter.

NOTE

- If you switch the counter while counting, you might miss 1 pulse at the time of switching.

◆ Summary

In GP-Pro EX, you can set up the initial value for each parameter. After the system is running, you can change parameters with system variables.

The procedure for changing the counting format is summarized below.

Setting Up Initial Values

Refer to the setup procedures for GP-Pro EX.

Changing After System is Running

1. Set counter operations and transition settings in [Change Counter Format]
2. Set the parameters in [Request Special I/O Parameter Change].
3. Acknowledge that the parameter has changed in [Special I/O Parameter Change Complete]
4. [Control Special I/O] to execute.
5. See [Special I/O State] for confirmation.

IMPORTANT

- The [Request Special I/O Parameter Change] and [Special I/O Parameter Change Completed] operations reflect all the CH parameters you change.
- Right after transferring, operations use parameter values set up in GP-Pro EX. Any restarts, which include going off-line, reset, and turning power OFF, use stored system variables as parameters.

◆ Set Up Process in GP-Pro EX

In [System Settings], select [I/O Driver] and click [High Speed Counter Settings] on the [Internal Driver] screen.

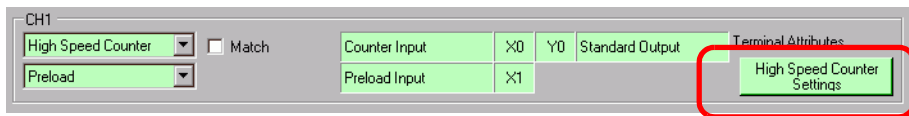

In the [High Speed Counter Settings] dialog box, select the Up or Down Count radio button in the Counter Operation area.

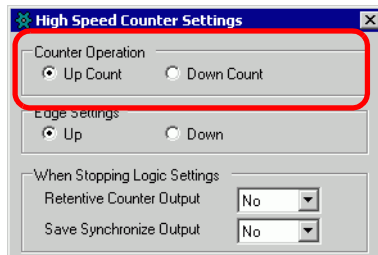

◆ **Set Up Process with System Variables**

- 1 Define the Counter format using the system variable #L_HSC*_MOD. The system variable name adjusts to match the CH pulse output to which it's mapped.
- 2 The system variable (#L_HSC*_MOD) details are as shown below. Turn 0 bit OFF to count up, and turn it ON to count down. Furthermore, turn the first bit to detect an up pulse and turn it OFF to detect a down pulse.

#L_HSC*_MOD

H	0	0	0	0	0	0	0	0	0	0	0	0	0	0	0	0
L	0	0	0	0	0	0	0	0	0	0	0	HSC method				

HSC method

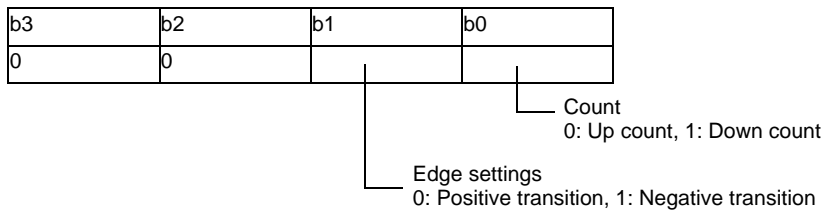

- 3 For the counting method, change the parameter under "Request special I/O parameter change."
"Request special I/O parameter change" changes the parameter in the system variable (#L_ExIOSpParmChg). Then, acknowledge the completion under [Special I/O parameter change completed]. Depending on the CH to which you allocate the parameter, the request flag and the completion flag will have different bit positions.

#L_ExIOSpParmChg

H	CH4 Special I/O parameter Changed successfully	CH3 Special I/O parameter Changed successfully	CH2 Special I/O parameter Changed successfully	CH1 Special I/O parameter Changed successfully
L	CH4 Special I/O parameter Change request	CH3 Special I/O parameter Change request	CH2 Special I/O parameter Change request	CH1 Special I/O parameter Change request

Request Special I/O Parameter Change

15	13	12	9	8	5	4	1	0			
Unused	h	g	Unused	f	e	Unused	d	c	Unused	b	a

This variable uses the CH specified in the I/O driver settings as the 4-bit configuration information to request the special I/O parameter change.

- a: CH1 special I/O parameter change request
- c: CH2 special I/O parameter change request
- e: CH3 special I/O parameter change request
- g: CH4 special I/O parameter change request

You can also read the previous settings using the Operation bits below.

- b: CH1 Special I/O Parameter Read Request
- d: CH2 Special I/O Parameter Read Request
- f: CH3 Special I/O Parameter Read Request
- h: CH4 Special I/O Parameter Read Request

4 The following illustration describes details about variables mapped to [Special I/O Parameter Change Completed]. The monitor bit differs, depending on the CH the high-speed counter is mapped to.

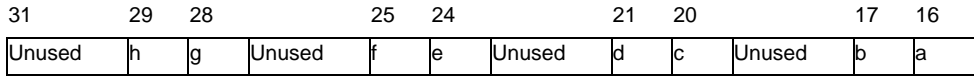

- a: CH1 special I/O parameter changed successfully
- c: CH2 special I/O parameter changed successfully
- e: CH3 special I/O parameter changed successfully
- g: CH4 special I/O parameter changed successfully

You can also read the previous settings using the watch bits below.

- b: CH1 Special I/O Parameter read successfully
- d: CH2 Special I/O Parameter read successfully
- f: CH3 Special I/O Parameter read successfully
- h: CH4 Special I/O Parameter read successfully

5 The figure below shows the flag timing chart for the special I/O parameter change request and completion.

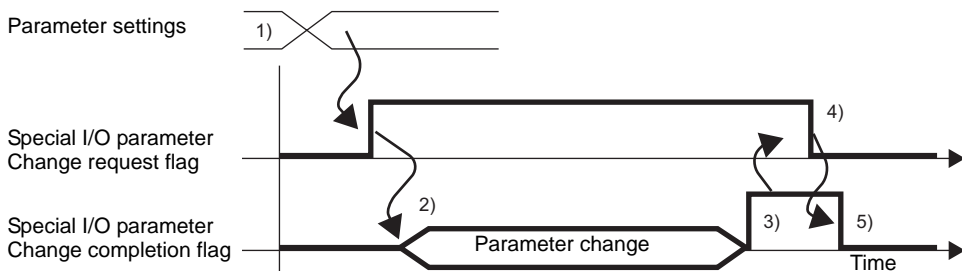

- 1) Configure settings for counting and edge.
- 2) Turn ON the request flag for the special I/O parameter change to change the parameter.
- 3) Once the parameter is changed, the completion flag turns ON.
- 4) Acknowledge that the completion flag is ON and turn the request flag OFF.
- 5) When the request flag is recognized as OFF, the completion flag turns OFF.

■ Controlling High Speed Counter Action

Use this function to start and stop the high-speed counter. Turn ON the high-speed counter flag under the CH special I/O control in the system variable (#L_ExIOSpCtrl) to start, and turn it OFF to stop the counter. The Operation bit will differ, depending on the CH to which you allocate the high-speed counter.

#L_ExIOSpCtrl

H	CH4 Special I/O state	CH3 Special I/O state	CH2 Special I/O state	CH1 Special I/O state
L	CH4 Special I/O control	CH3 Special I/O control	CH2 Special I/O control	CH1 Special I/O control

Special I/O control

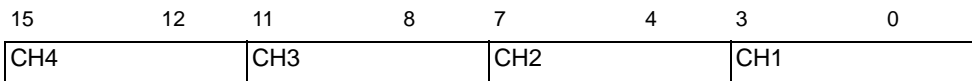

To start, turn ON the start bit (bit 0) for each CH, and to stop, turn it OFF.

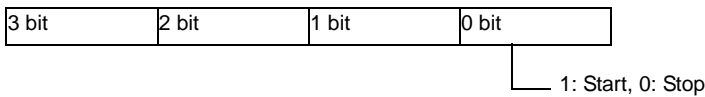

■ High Speed Counter Action Status

This function shows the high-speed counter state. The high-speed counter flag shows the counter state under the CH special I/O state in the system variable (#L_ExIOSpCtrl). If the flag is ON, the counter is ON. If the flag is OFF, the counter is OFF. The watch bit will differ, depending on the CH to which you allocate the high-speed counter.

Special I/O state

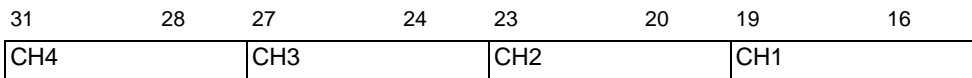

If the start bit (bit 0) of each CH is 1, the counter is ON. If it is 0, the counter is OFF.

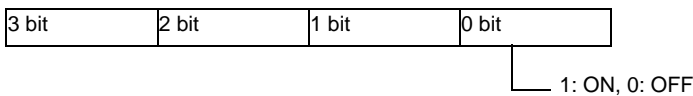

■ Function to Clear the Current Counter Value

Use this function to clear the current counter value. Furthermore, you can acknowledge that the current value is cleared. You can use the clearing feature is available whether the counter is ON or OFF.

To clear the current counter value with 0, turn ON the clear flag under the CH counter input control request in the system variable (#L_ExIOCntInCtrl). The Operation bit will differ, depending on the CH to which you allocate the high-speed counter.

#L_ExIOCntInCtrl

H	CH4 Counter Input Control response	CH3 Counter Input Control response	CH2 Counter Input Control response	CH1 Counter Input Control response
L	CH4 Counter Input Control request	CH3 Counter Input Control request	CH2 Counter Input Control request	CH1 Counter Input Control request

Counter input control request

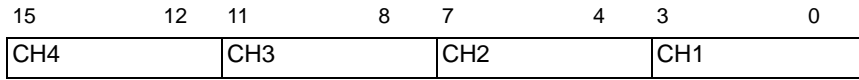

Turn ON the start bit (bit 0) of each CH to clear the counter value.

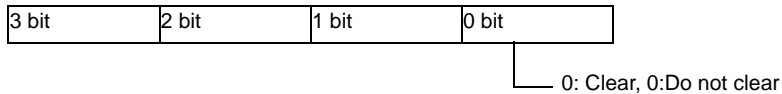

For variables allocated in [Counter Input Control Response], the watch bit differs depending on which CH you allocate the high-speed counter to, as shown below.

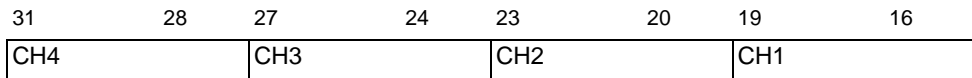

If the start bit of the CH (bit 0) is 1, the value has been cleared. If it is 0, the value has not been cleared.

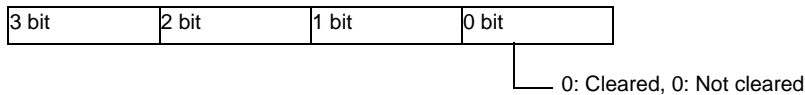

The following figure shows the flag timing chart for clearing current counter value and completion.

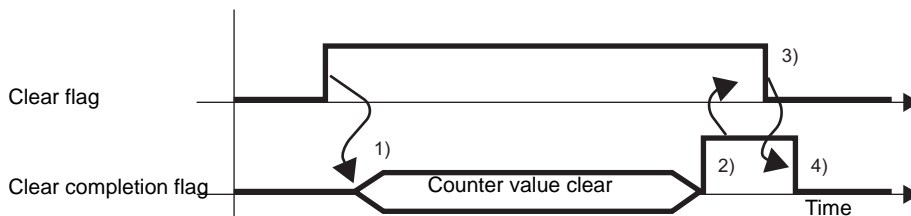

- 1) Turn on the request flag for the counter value clear to clear the current counter value.
- 2) Once the current counter value is cleared, the completion flag of the count value clear turns ON.
- 3) Acknowledge that the completion flag of the counter value clear is ON and turn OFF the request flag for the counter value clear.
- 4) When the request flag for the counter value clear is recognized as OFF, the completion flag of the counter value clear turns OFF.

■ Preload (Change value)

Use the Preload function to rewrite the current counter value with a value of your choice. Use the external input or the request flag to write the value.

Turn the preload request flag ON under the CH counter input control request in the system variable (#L_ExIOCntInCtrl) to write the current counter value with the system variable (#L_HSC*_PLV) using the preload feature. The Operation bit will differ, depending on the CH to which you allocate the high-speed counter.

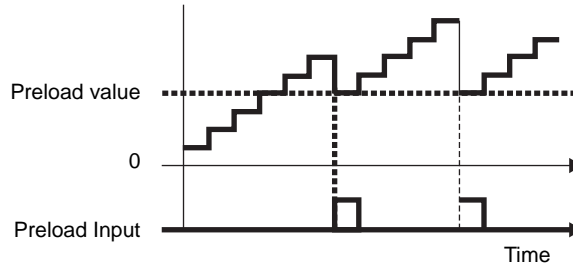

◆ Summary

In GP-Pro EX, you can set up the initial value for each parameter. After the system is running, you can change parameters with system variables.

The procedure for setting the preload input is summarized below.

Setting Up Initial Values

Refer to the setup procedures for GP-Pro EX

Changing After System is Running

Set the preload value.

Set the parameter [Request Special I/O Parameter Change].

In [Special I/O Parameter Change Completed], acknowledge that the parameter has been changed.

Write the value with the external input or the request flag.

If you use the external input for rewrite, acknowledge the value in [Show Counter External Input Completed]. If you use the request flag for rewrite, acknowledge the value in [Special I/O State].

IMPORTANT

- The [Request Special I/O Parameter Change] and [Special I/O Parameter Change Completed] operations reflect all the CH parameters you change.
- Right after transferring, operations use parameter values set up in GP-Pro EX. Any restarts, which include going off-line, reset, and turning power OFF, use stored system variables as parameters.

◆ **Set Up Process in GP-Pro EX**

In [System Settings], select [I/O Driver] and click [High Speed Counter Settings] on the [Internal Driver 1] screen.

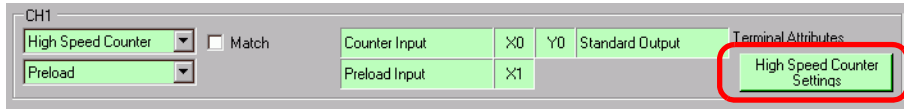

In the [High Speed Counter Settings] dialog box, select the preload value from the Preload Value field.

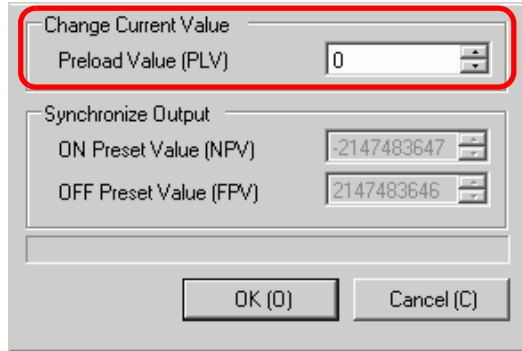

◆ **Set Up Process with System Variables**

- 1 The preload value is specified with system variables (#L_HSC*_PLV). The system variable name adjusts to match the CH pulse output to which it's mapped.
- 2 To specify the value from the system variable (#L_HSC*_PLV), change the parameter under "Request special I/O parameter change" (#L_ExIOSpParmChg).

#L_ExIOSpParmChg

H	CH4 Special I/O parameter Changed successfully	CH3 Special I/O parameter Changed successfully	CH2 Special I/O parameter Changed successfully	CH1 Special I/O parameter Changed successfully
L	CH4 Special I/O parameter Change request	CH3 Special I/O parameter Change request	CH2 Special I/O parameter Change request	CH1 Special I/O parameter Change request

Request Special I/O Parameter Change

15	13	12	9	8	5	4	1	0			
Unused	h	g	Unused	f	e	Unused	d	c	Unused	b	a

This variable uses the CH specified in the I/O driver settings as the 4-bit configuration information to request the special I/O parameter change.

- a: CH1 special I/O parameter change request
- c: CH2 special I/O parameter change request
- e: CH3 special I/O parameter change request
- g: CH4 special I/O parameter change request

You can also read the previous settings using the Operation bits below.

- b: CH1 Special I/O Parameter Read Request
- d: CH2 Special I/O Parameter Read Request
- f: CH3 Special I/O Parameter Read Request
- h: CH4 Special I/O Parameter Read Request

3 Acknowledge the completion in [Special I/O Parameter Change Completed]. Regarding the details of the variable, the watch bit will differ, depending on the CH to which you allocate the high-speed counter, as shown below.

Special I/O parameter change completed

31	29	28	25	24	21	20	17	16			
Unused	h	g	Unused	f	e	Unused	d	c	Unused	b	a

- a: CH1 special I/O parameter changed successfully
- c: CH2 special I/O parameter changed successfully
- e: CH3 special I/O parameter changed successfully
- g: CH4 special I/O parameter changed successfully

You can also read the previous settings using the watch bits below.

- b: CH1 Special I/O Parameter read successfully
- d: CH2 Special I/O Parameter read successfully
- f: CH3 Special I/O Parameter read successfully
- h: CH4 Special I/O Parameter read successfully

4 The figure below shows the flag timing chart for the special I/O parameter change request and completion.

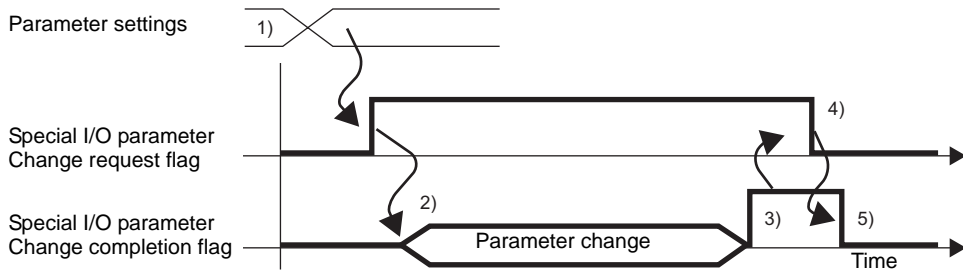

- 1) Set the preload value.
- 2) Turn ON the request flag for the special I/O parameter change to change the parameter.
- 3) Once the parameter is changed, the completion flag turns ON.
- 4) Acknowledge that the completion flag is ON and turn the request flag OFF.
- 5) When the request flag is recognized as OFF, the completion flag turns OFF.

◆ **Rewriting value with the external input or the request flag**

There are two types of triggers for rewriting the current counter value with a value of your choice. They are [A] External input and [B] Request flag.

- [A] External input trigger

When the signal of the preload input terminal that is specified in [I/O Driver] turns ON, the current value is written with the value stored in the preload value variable.

When the signal of the preload input terminal specified in [I/O Driver] turns ON, you can check whether the change was completed successfully. The setup procedure is shown below.

How to acknowledge the rewrite completion

- 1 Use the system variable (#L_ExIOCntInExtCtrl).

#L_ExIOCntInExtCtrl

H	CH4 Counter external input Completion acknowledgment	CH3 Counter external input Completion acknowledgment	CH2 Counter external input Completion acknowledgment	CH1 Counter external input Completion acknowledgment
L	CH4 Counter external input Completed	CH3 Counter external input Completed	CH2 Counter external input Completed	CH1 Counter external input Completed

2 Regarding the details of the variable allocated in [Counter External Input Completed], the watch bit differs, depending on the CH on which you allocate the high-speed counter, as shown below.

15	12	11	8	7	4	3	0
Unused	d	Unused	c	Unused	b	Unused	a

- a: CH1 preload completed
- b: CH2 preload completed
- c: CH3 preload completed
- d: CH4 preload completed

3 Regarding the details of the variable allocated in [Acknowledge Counter External Input Completed], the operation bit differs, depending on the CH on which you allocate the high-speed counter, as shown below.

31	28	27	24	23	20	19	16
Unused	d	Unused	c	Unused	b	Unused	a

- a: CH1 preload completion acknowledged
- b: CH2 preload completion acknowledged
- c: CH3 preload completion acknowledged
- d: CH4 preload completion acknowledged

4 The figure below shows the timing chart for [Preload Operation Complete] and [Acknowledge Preload Operation Complete].

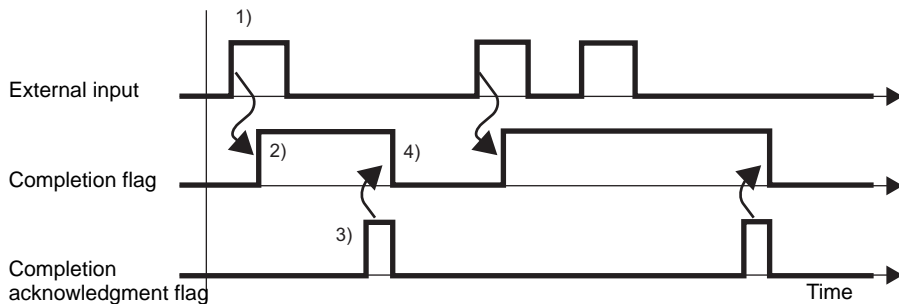

- 1) When the external input turns ON, the value is rewritten with the preload value.
- 2) Once the rewrite is complete, the completion flag of the preload operation turns ON.
- 3) Acknowledge that the completion flag of the preload operation is ON and turn ON the completion acknowledgment flag of the preload operation.
- 4) When the acknowledgment flag of the preload operation is recognized as ON, the completion flag of the preload operation turns OFF.

- [B] Request flag trigger

Turning on the preload request flag under the CH counter input control request in the system variable (#L_ExIOCntInCtrl) enables rewrite operation for the current counter value. The preload-completed flag under the CH counter input-control response in the system variable (#L_ExIOCntInCtrl) turns ON when writing of the current counter value is completed. The Operation bit and Monitor bit differ depending on the CH to which you allocate the high-speed counter.

How to acknowledge the rewrite completion

1 Use the system variable (#L_ExIOCntInCtrl).

#L_ExIOCntInCtrl

H	CH4 Counter Input Control response	CH3 Counter Input Control response	CH2 Counter Input Control response	CH1 Counter Input Control response
L	CH4 Counter Input Control request	CH3 Counter Input Control request	CH2 Counter Input Control request	CH1 Counter Input Control request

2 For variables allocated in [Counter input control request], the operation bit will differ depending on the CH to which you allocate the high-speed counter, as shown below.

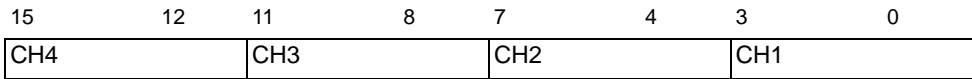

Turn ON the 2nd bit of the CH to rewrite the value.

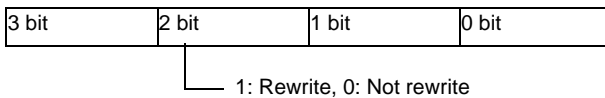

3 For variables allocated in [Counter Input Control Response], the watch bit differs depending on the CH to which you allocate the high-speed counter, as shown below.

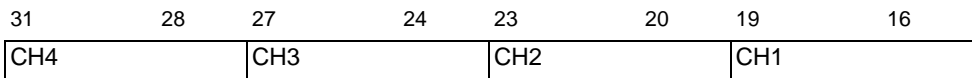

If the 2nd bit of the CH is 1, the value has been rewritten. If it is 0, the value has not been rewritten.

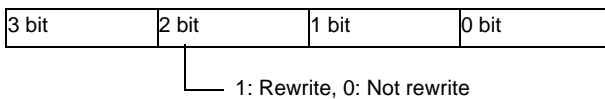

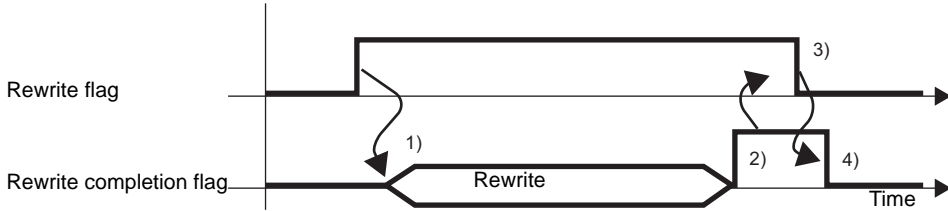

- 1) Turn ON request flag for the counter input control to rewrite the value.
- 2) Once the rewrite is completed, the rewrite completion flag turns ON.
- 3) Acknowledge that the completion flag is ON and turn OFF the rewrite flag.
- 4) When the rewrite flag is recognized as OFF, the rewrite completion flag turns OFF.

■ Prestrobe (Current Value Memory)

Prestrobe is a feature that memorizes the current counter value. Use the external input or the request flag to memorize the value.

Turn ON the prestrobe request flag under the CH counter input control request in the system variable (#L_ExIOCntInCtrl) to obtain the counter value in the system variable (#L_HSC*_PSV). The Operation bit will differ, depending on the CH to which you allocate the high-speed counter.

◆ Summary

The setup procedure for the prestrobe is summarized below.

1. Store the value with the external input or the request flag.
2. If you use the external input to store, acknowledge the value in [Show Counter External Input Completed].

If you use the request flag to store, acknowledge the value in [Special I/O State].

IMPORTANT

- The [Request Special I/O Parameter Change] and [Special I/O Parameter Change Completed] operations reflect all the CH parameters you change.
- Right after transferring, operations use parameter values set up in GP-Pro EX. Any restarts, which include going off-line, reset, and turning power OFF, use stored system variables as parameters.

- [A] External input trigger

When the signal of the prestrobe input terminal that is specified in [I/O driver] turns ON, the current count value is stored in the system variable (#L_HSC*_PSV).

Signal of the prestrobe input terminal specified in [I/O Driver Settings] turns on, and you can check whether storing is completed. The setup procedure is shown below.

How to acknowledge the storing completion

1 Use the system variable (#L_ExIOCntInExtCtrl).

#L_ExIOCntInExtCtrl

H	CH4 Counter external input Completion acknowledgment	CH3 Counter external input Completion acknowledgment	CH2 Counter external input Completion acknowledgment	CH1 Counter external input Completion acknowledgment
L	CH4 Counter external input Completed	CH3 Counter external input Completed	CH2 Counter external input Completed	CH1 Counter external input Completed

2 Regarding the details of the variable allocated in [Counter External Input Completed], the watch bit differs, depending on the CH on which you allocate the high-speed counter, as shown below.

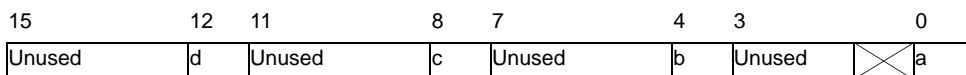

- a: CH1 prestrobe completed
- b: CH2 prestrobe completed
- c: CH3 prestrobe completed
- d: CH4 prestrobe completed

3 Regarding the details of the variable allocated in [Acknowledge Counter External Input Completed], the operation bit differs, depending on the CH on which you allocate the high-speed counter, as shown below.

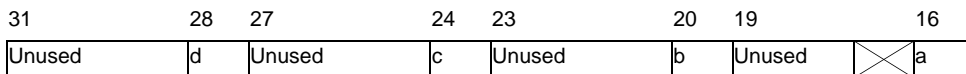

- a: CH1 prestrobe completion acknowledged
- b: CH2 prestrobe completion acknowledged
- c: CH3 prestrobe completion acknowledged
- d: CH4 prestrobe completion acknowledged

4 The figure below shows a timing chart for [Show Counter External Input Completed] and [Acknowledge Counter External Input Completed].

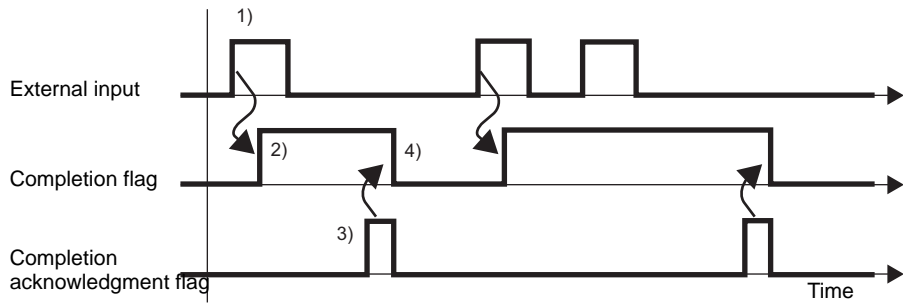

- 1) When the external input turns ON, the current count value is stored in the system variable (#L_HSC*_PSV).
- 2) Once the value is stored, the completion flag of the counter external input turns ON.
- 3) Acknowledge that the completion flag of the counter external input is ON and turn ON the completion acknowledgment flag of the counter external input.
- 4) When the acknowledgment flag of the counter external input is recognized as ON, the completion flag of the counter external input turns OFF.

- [B] Request flag trigger

Turn ON the prestrobe request flag under the CH counter input control request in the system variable (#L_ExIOCntInCtrl) to memorize the current counter value.

The prestrobe completed flag under the CH counter input control response in the system variable (#L_ExIOCntInCtrl) turns ON when saving of the current counter value is completed. The Operation bit and Monitor bit differ depending on the CH to which you allocate the high-speed counter.

How to acknowledge the storing completion

1 Use the system variable (#L_ExIOCntInCtrl).

#L_ExIOCntInCtrl

H	CH4 Counter Input Control response	CH3 Counter Input Control response	CH2 Counter Input Control response	CH1 Counter Input Control response
L	CH4 Counter Input Control request	CH3 Counter Input Control request	CH2 Counter Input Control request	CH1 Counter Input Control request

2 For variables allocated in [Counter input control request], the operation bit will differ depending on the CH to which you allocate the high-speed counter, as shown below.

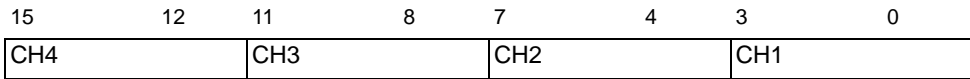

Turn on the 3rd bit of the CH to store the current count value.

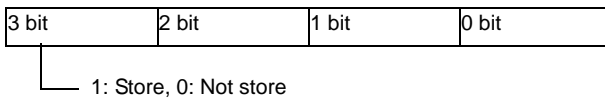

3 For variables allocated in [Counter Input Control Response], the watch bit differs depending on the CH to which you allocate the high-speed counter, as shown below.

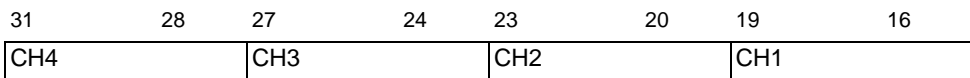

If the 3rd bit of the CH is 1, the value has been stored. If it is 0, the value has not been stored.

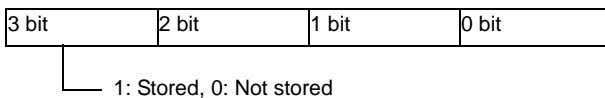

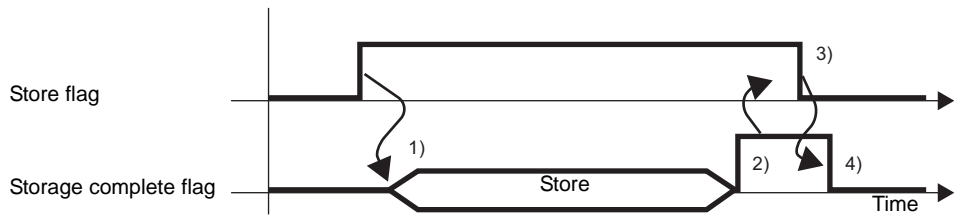

- 1) Turn ON the request flag for the counter input control to store the value.
- 2) Once the value is stored, the Storage complete flag turns ON.
- 3) Acknowledge that the Storage complete flag is ON and turn the store flag OFF.
- 4) When the store flag is recognized as OFF, the Storage complete flag turns OFF.

■ Synchronize Output

Synchronize output is output that turns ON when the current counter value exceeds the ON preset value and turns OFF when the counter value exceeds the OFF preset value. Since the synchronize output changes the output state only at the point when the current counter value exceeds the ON preset value or when the counter value exceeds the OFF preset value, the synchronize output saves the state even when you change the counter value using operations such as clear preload and counter value. If you turn OFF the synchronize output enable/disable flag while synchronizing output, the synchronize output turns OFF. However, the output does not turn ON if you turn ON the synchronize output enable/disable flag while in that state (even when the state satisfies the conditions for turning on synchronize output).

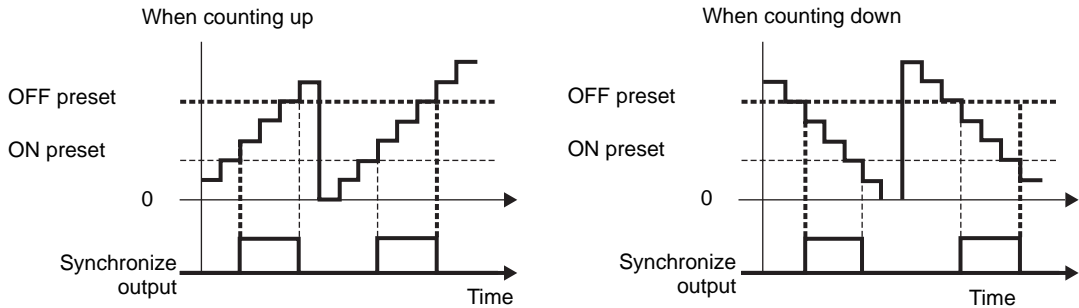

◆ Summary

In GP-Pro EX, you can set up the initial value for each parameter. After the system is running, you can change parameters with system variables.

The procedure for setting the synchronize output is summarized below.

Setting Up Initial Values

Refer to the setup procedures for GP-Pro EX

Changing After System is Running

1. Set the ON preset value and the OFF preset value.
2. Set the parameter under [Request Special I/O Parameter change].
3. Under [Special I/O Parameter Change Completed], acknowledge that the parameter has been changed.
4. Enable the synchronize output under [Control Special I/O].
5. See "Special I/O state" for acknowledgment.

IMPORTANT

- The [Request Special I/O Parameter Change] and [Special I/O Parameter Change Completed] operations reflect all the CH parameters you change.
- You cannot define 65535 or 65536 for the ON Preset Value or OFF Preset Value. (Values with the bottom 16 bits in the ON Preset Value or OFF Preset Value of xxxxFFFFh or xxxx0000h cannot be specified.)
- Right after transferring, operations use parameter values set up in GP-Pro EX. Any restarts, which include going off-line, reset, and turning power OFF, use stored system variables as parameters.

◆ **Preset value settings**

To set the ON preset value and the OFF preset value, change the parameter under "Request special I/O parameter change" in the system variable (#L_ExIOSpParmChg). Then, acknowledge the completion under [Special I/O parameter change completed]. Depending on the CH where you allocate the high-speed counter, the request flag and completion flag will have different bit positions.

- 1 Specify the ON preset value and the OFF preset value using GP-Pro EX or the system variable.

For GP-Pro EX

In [System Settings], select [I/O Driver] and select the "Match" check box on the [Internal Driver 1] screen and click [High Speed Counter Settings].

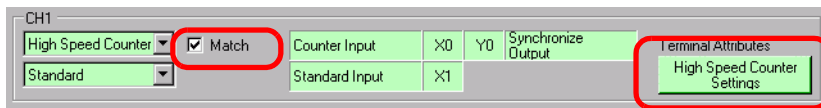

In the [High Speed Counter Settings] dialog box, select the value from the Synchronize Output.

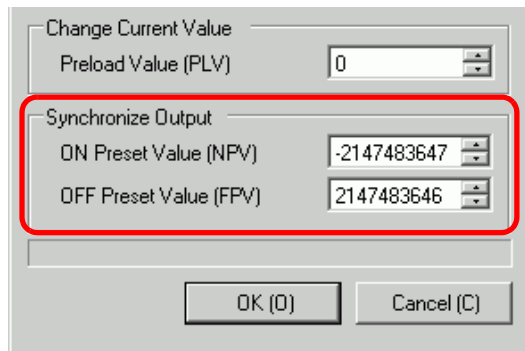

For the system variable

Select the value from the ON preset (#L_HSC*_ONP) and the OFF preset (#L_HSC*_OFF).

Name	Variable	IEC Address
Standard Input		
Standard Output		
High Speed Counter[CH1]		
#L_HSC1_MDD	(Counter System)	
#L_HSC1_PLV	(Preload Value)	
#L_HSC1_PSV	(Prestrobe Value)	
#L_HSC1_ONP	(ON Preset Value)	
#L_HSC1_OFF	(OFF Preset Value)	
#L_HSC1_HCV	(Counter Current Value)	

2 To specify the value from the system variable, change the parameter under [Request Special I/O Parameter Change].

#L_ExIOSpParmChg

H	CH4 Special I/O parameter Changed successfully	CH3 Special I/O parameter Changed successfully	CH2 Special I/O parameter Changed successfully	CH1 Special I/O parameter Changed successfully
L	CH4 Special I/O parameter Change request	CH3 Special I/O parameter Change request	CH2 Special I/O parameter Change request	CH1 Special I/O parameter Change request

Request Special I/O Parameter Change

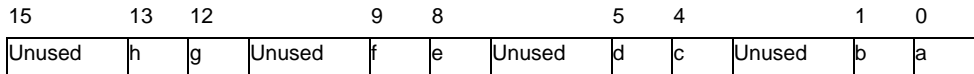

This variable uses the CH specified in the I/O driver settings as the 4-bit configuration information to request the special I/O parameter change.

- a: CH1 special I/O parameter change request
- c: CH2 special I/O parameter change request
- e: CH3 special I/O parameter change request
- g: CH4 special I/O parameter change request

You can also read the previous settings using the Operation bits below.

- b: CH1 Special I/O Parameter Read Request
- d: CH2 Special I/O Parameter Read Request
- f: CH3 Special I/O Parameter Read Request
- h: CH4 Special I/O Parameter Read Request

3 Acknowledge the completion in [Special I/O Parameter Change Completed]. Regarding the details of the variable, the watch bit will differ, depending on the CH to which you allocate the high-speed counter, as shown below.

Special I/O parameter change completed

31	29	28		25	24		21	20		17	16
Unused	h	g	Unused	f	e	Unused	d	c	Unused	b	a

- a: CH1 special I/O parameter changed successfully
- c: CH2 special I/O parameter changed successfully
- e: CH3 special I/O parameter changed successfully
- g: CH4 special I/O parameter changed successfully

You can also read the previous settings using the watch bits below.

- b: CH1 Special I/O Parameter read successfully
- d: CH2 Special I/O Parameter read successfully
- f: CH3 Special I/O Parameter read successfully
- h: CH4 Special I/O Parameter read successfully

4 The figure below shows the flag timing chart for the special I/O parameter change request and completion.

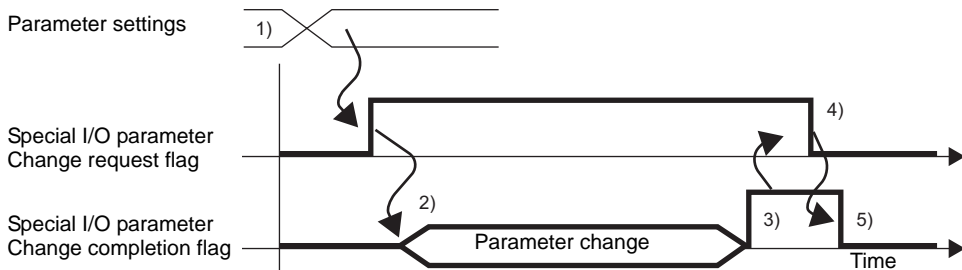

- 1) Set the ON preset value and the OFF preset value.
- 2) Turn on request flag for the special I/O parameter change to change the parameter to the set value.
- 3) Once the parameter is changed, the completion flag turns ON.
- 4) Acknowledge that the completion flag is ON and turn the request flag OFF.
- 5) When the request flag is recognized as OFF, the completion flag turns OFF.

◆ **Preset value error status**

It shows any error status in the ON preset value and the OFF preset value during the synchronize output. If the system variable (#L_IOStatus0) shows the error code 100, you can acknowledge the error status from the system variable (#L_ExIOSpParmErr) value. The watch bit will differ, depending on the CH to which you allocate the high-speed counter.

IMPORTANT

- When changing Special I/O parameters, and the preset value is invalid, operations continue by using parameters set up to that point. However, since an invalid value is stored in the system, make sure you change it to a valid value. If you restart the LT with invalid values (go off-line, reset, or turn the power OFF), operations will use initial parameter values set up in GP-Pro EX.

#L_ExIOSpParmErr

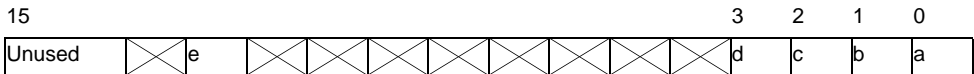
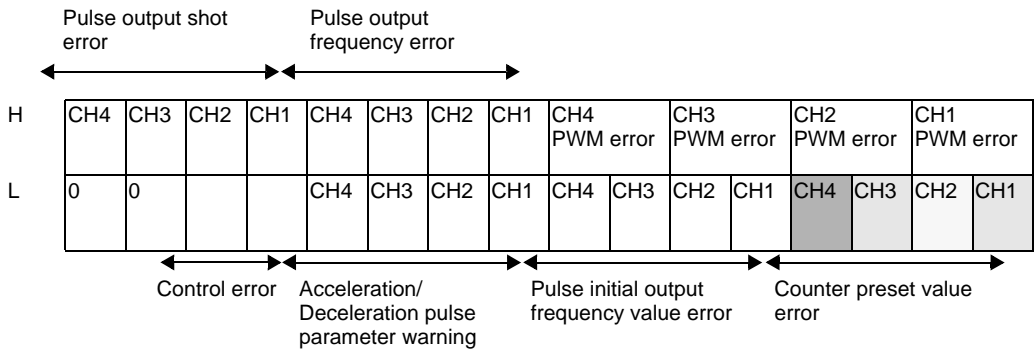

- a: CH1 counter preset value error 1: Preset value error
0: Normal
- b: CH2 counter preset value error 1: Preset value error
0: Normal
- c: CH3 counter preset value error 1: Preset value error
0: Normal
- d: CH4 counter preset value error 1: Preset value error
0: Normal
- e: Counter input control error 1: Preset value control error (bottom 16 bits in
preset value is FFFFh or 0000h)
0: Normal

◆ **Synchronize output control**

Use this function to enable or disable the synchronize output. Turn on the synchronize output flag under the CH special I/O control in the system variable (#L_ExIOSpCtrl) to enable and turn the flag off to disable the output. The Operation bit will differ, depending on the CH to which you allocate the high-speed counter.

#L_ExIOSpCtrl

H	CH4 Special I/O state	CH3 Special I/O state	CH2 Special I/O state	CH1 Special I/O state				
L	CH4 Special I/O control	CH3 Special I/O control	CH2 Special I/O control	CH1 Special I/O control				
	15	12	11	8	7	4	3	0
	CH4		CH3		CH2		CH1	

Turn on the 1st bit of the CH to enable and turn it off to disable the output.

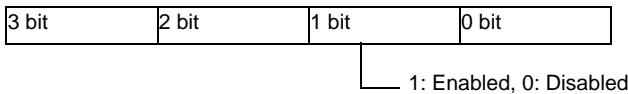

◆ **Synchronize output status**

This function shows whether the synchronize output is enabled or disabled. You can acknowledge the enable/disable status of the synchronize output with the synchronize output flag under the CH special I/O state in the system variable (#L_ExIOSpCtrl). If the flag is ON, the output is enabled. If it is OFF, the output is disabled. The watch bit will differ, depending on the CH to which you allocate the high-speed counter.

#L_ExIOSpCtrl

H	CH4 Special I/O state	CH3 Special I/O state	CH2 Special I/O state	CH1 Special I/O state				
L	CH4 Special I/O control	CH3 Special I/O control	CH2 Special I/O control	CH1 Special I/O control				
	31	28	27	24	23	20	19	16
	CH4		CH3		CH2		CH1	

If the 1st bit of the CH is 1, the synchronize output is enabled. If it is 0, the output is disabled.

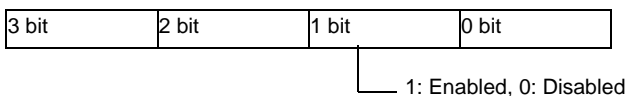

◆ **Output clear feature during the synchronize output**

Use this function to turn OFF the output during the synchronize output. You can also acknowledge the synchronize output being cleared.

You can use the synchronize output clear feature whether the counter is ON or OFF. Turn On the synchronize output clear flag under the CH counter input control request in the system variable (#L_ExIOCntInCtrl) to turn OFF the synchronize output. The Operation bit will differ, depending on the CH to which you allocate the high-speed counter.

#L_ExIOCntInCtrl

H	CH4 Counter Input Control response	CH3 Counter Input Control response	CH2 Counter Input Control response	CH1 Counter Input Control response
L	CH4 Counter Input Control request	CH3 Counter Input Control request	CH2 Counter Input Control request	CH1 Counter Input Control request

Counter input control request

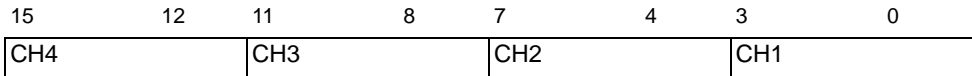

Turn ON the 1st bit of the CH to turn OFF the output.

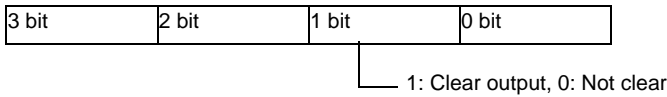

The following figure shows the flag timing chart for the synchronize output and the synchronize output clear.

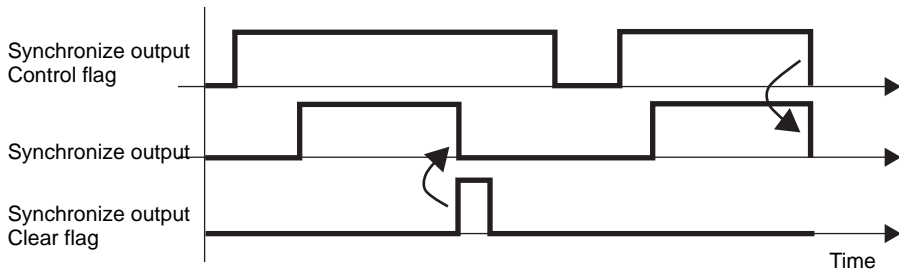

Counter input control response

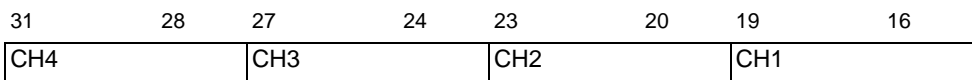

If the 1st bit of the CH is 1, the synchronize output has been cleared.

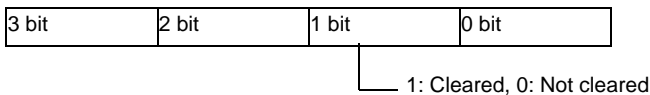

◆ **Synchronize output terminal status**

You can acknowledge the synchronize output status in the output terminal with the system variable (#L_ExIOSpOut). The watch bit will differ, depending on the CH to which you allocate the high-speed counter.

#L_ExIOSpOut

H	0	0	0	0	0	0	0	0	0	0	0	0	0	0	0	0
L	CH4 information				CH3 information				CH2 information				CH1 information			

15	12			8			4			0		
Unused	d	Unused	c	Unused	b	Unused	a					

- a: CH1 output state 1: Output, 0: Not output
- b: CH2 output state 1: Output, 0: Not output
- c: CH3 output state 1: Output, 0: Not output
- d: CH4 output state 1: Output, 0: Not output

30.5.8 High speed counter (2-phase settings)







A 2-phase counter is a counter that takes two input terminals to measure the input signal of a 2-phase input.

A maximum of two 2-phase counters can be used. When you use one, you use X0 and X2 input terminals, and when you use two, you use X0 and X2 as well as X4 and X6 input terminals. Because two CH1 input terminals and two CH2 input terminals are occupied, allocated terminal arrangement differs from that of a single counter. Feature and setting methods for preload input, prestrobe input, and matching input are the same as that of a single counter.

The main functions of the 2-phase counters are indicated in the following table.

NOTE

- Some of the settings can be configured in the logic program's I/O driver instructions.
 "31.24 I/O Driver Instructions" (page 31-575)

Summary of functions	Browse to
Clears the counter, which currently has an external signal value.	 "30.5.8 High speed counter (2-phase settings) ■ Marker Input" (page 30-87)
Starts and stops the high-speed counter	 "30.5.7 High Speed Counter (Single-phase Settings) ■ Controlling High Speed Counter Action" (page 30-61)
Checks the start and stop status of the high-speed counter	 "30.5.7 High Speed Counter (Single-phase Settings) ■ High Speed Counter Action Status" (page 30-61)
Rewrites the current counter value	 "30.5.7 High Speed Counter (Single-phase Settings) ■ Preload (Change value)" (page 30-63)
Stores the current counter value (read)	 "30.5.7 High Speed Counter (Single-phase Settings) ■ Prestrobe (Current Value Memory)" (page 30-69)
Outputs the current counter value when it exceeds the specified value	 "30.5.7 High Speed Counter (Single-phase Settings) ■ Synchronize Output" (page 30-74)
Save the counter value when the logic stops	 "30.5.6 High Speed Counter (Common) ■ Retaining Counter Value and Retaining Matching Output when the Logic Stops" (page 30-56)

As for measuring methods, there are four types of modes ranging from "Phase Counting Mode 0" to "Phase Counting Mode 3".

◆ **Mode 0 (2 Phase x 4)**

When Counter A (A Phase) is ahead of Counter B (B Phase), operates as an up counter. When Counter A (A Phase) is lagging behind Counter B (B Phase), operates as a down counter.

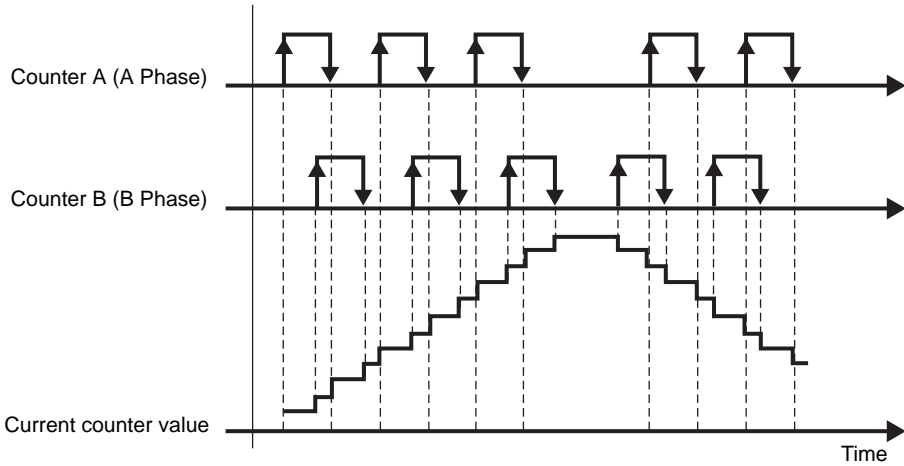

Counter A (A Phase) is ahead of Counter B (B Phase)

Counter A (A Phase)	Counter B (B Phase)	Operations
1 (High)	Positive transition	Up Count
0 (Low)	Negative transition	
Negative transition	1 (High)	
Positive transition	0 (Low)	

Counter A (A Phase) is lagging behind Counter B (B Phase)

Counter A (A Phase)	Counter B (B Phase)	Operations
0 (Low)	Positive transition	Down Count
1 (High)	Negative transition	
Negative transition	0 (Low)	
Positive transition	1 (High)	

◆ **Mode 1 (Counter + Direction)**

Begins counting at the positive transition of Counter A (A Phase). If Counter B (B Phase) is 0 (Low), it counts up, if 1 (High), it counts down.

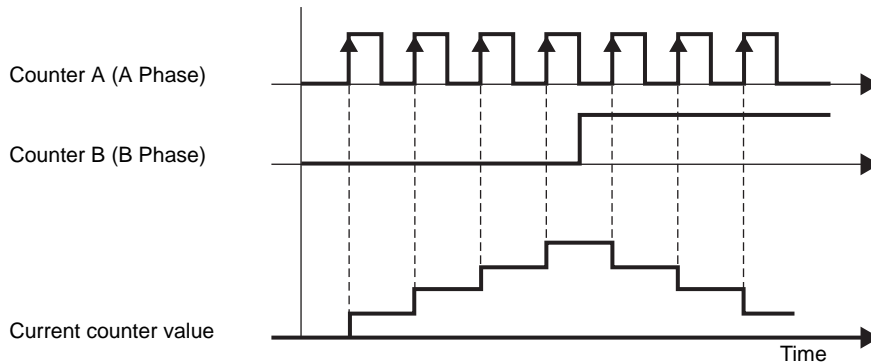

Counter A (A Phase)	Counter B (B Phase)	Operations
1 (High)	Positive transition	Not count
0 (Low)	Negative transition	
Negative transition	1 (High)	Up Count
Positive transition	0 (Low)	
0 (Low)	Positive transition	Not count
1 (High)	Negative transition	
Negative transition	0 (Low)	Down Count
Positive transition	1 (High)	

◆ **Mode 2 (Up + Down)**

When Counter A (A Phase) has a positive transition and Counter B (B Phase) is 0 (Low), operates as an up counter. When Counter B (B Phase) has a positive transition and Counter A (A Phase) is 0 (Low), operates as a down counter.

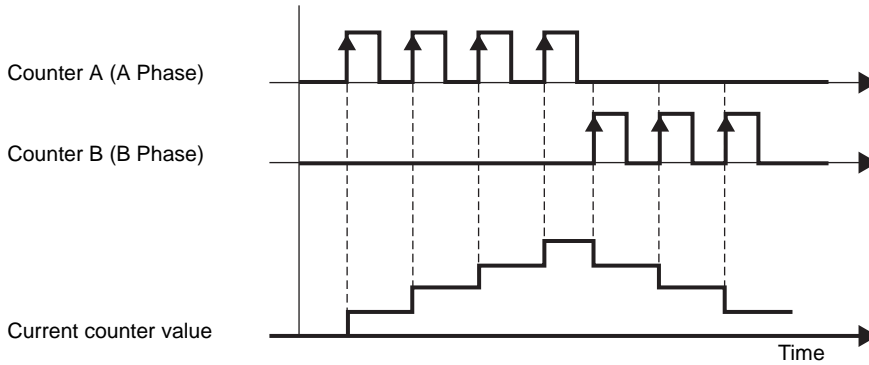

Counter A (A Phase)	Counter B (B Phase)	Operations
1 (High)	Positive transition	Not count
0 (Low)	Negative transition	
Negative transition	1 (High)	Up Count
Positive transition	0 (Low)	
0 (Low)	Positive transition	Down Count
1 (High)	Negative transition	Not count
Negative transition	0 (Low)	
Positive transition	1 (High)	

◆ **Mode 3 (2 Phase x 2)**

Begins counting at a Counter B (B Phase) positive or negative transition. When Counter A (A Phase) is ahead of Counter B (B Phase), it counts up. When Counter A (A Phase) is lagging behind Counter B (B Phase), it counts down.

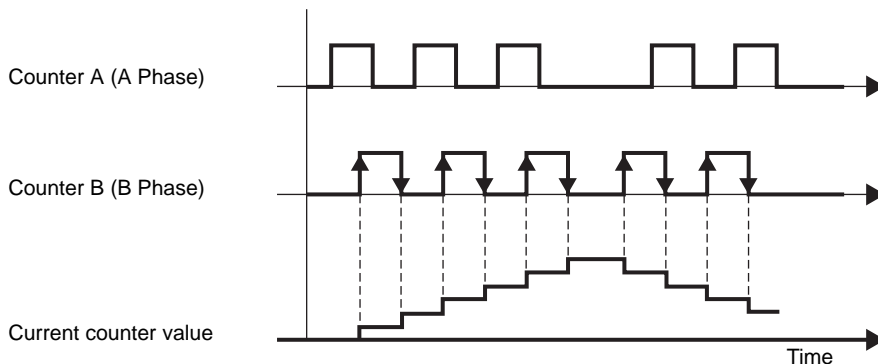

Counter A (A Phase) is ahead of Counter B (B Phase)

Counter A (A Phase)	Counter B (B Phase)	Operations
1 (High)	Positive transition	Up Count
0 (Low)	Negative transition	
Negative transition	1 (High)	Not count
Positive transition	0 (Low)	

Counter A (A Phase) is lagging behind Counter B (B Phase)

Counter A (A Phase)	Counter B (B Phase)	Operations
0 (Low)	Positive transition	Down Count
1 (High)	Negative transition	
Negative transition	0 (Low)	Not count
Positive transition	1 (High)	

◆ Phase Calculation Mode Settings

1 Select [I/O Driver] in [System Settings].

2 On the [Internal Driver 1] screen, select the [2 Phase Counter] check box and click [2 Phase Counter Settings].

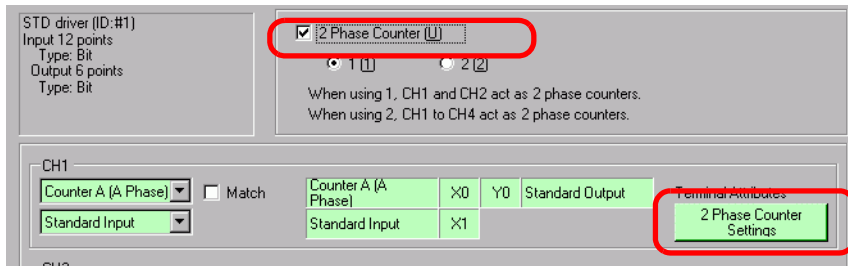

3 The [2 Phase Counter Settings] dialog box appears. Select the phase calculation mode from the pull-down menu.

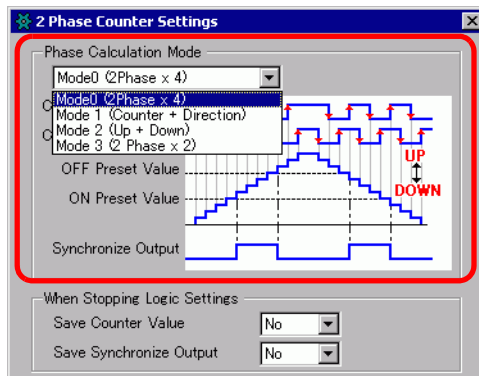

■ Marker Input

Use this function to clear the current count value using the external input signal when the 2-phase counter is operating. You can also acknowledge the current count value being cleared. You can only allocate the input terminal of X3 and X7 to the marker input (external input signal).

◆ How to acknowledge the marker input

When the marker input is detected in the external input, the completion flag of the 2-phase marker input under the CH Counter external input completed in the system variable (#L_ExIOCntInExtCtrl) turns ON.

Then, turn on the completion acknowledgment flag of 2-phase marker input to detect the marker input once again. The Operation bit will differ, depending on the CH to which you allocate the high-speed counter.

#L_ExIOCntInExtCtrl

H	CH4 Counter external input Completion acknowledgment	CH3 Counter external input Completion acknowledgment	CH2 Counter external input Completion acknowledgment	CH1 Counter external input Completion acknowledgment
L	CH4 Counter external input Completed	CH3 Counter external input Completed	CH2 Counter external input Completed	CH1 Counter external input Completed

1 The 1st bit in [Counter External Input Completed] is the input completion flag.

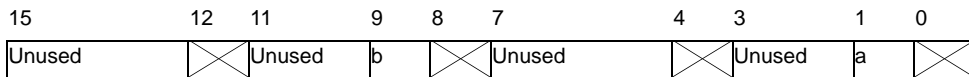

- a: CH1 2-phase counter input marker input completed
- b: CH3 2-phase counter input marker input completed

2 The 1st bit in [Acknowledge Counter External Input Completed] is the input completion acknowledgement flag.

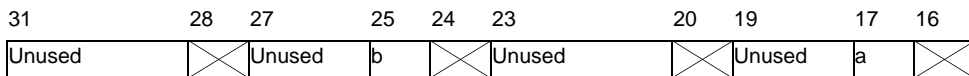

- a: CH1 2-phase counter input marker input completion acknowledged
- b: CH3 2-phase counter input marker input completion acknowledged



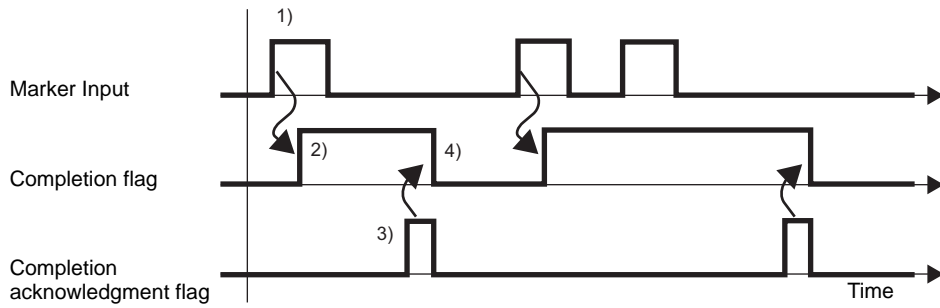



3 The figure below shows the timing chart for [Counter External Input Completed] and [Acknowledge Counter External Input Completed].



- 1) When the marker input turns ON, the count value is cleared.
- 2) Once the count value is cleared, the completion flag of the counter external input turns ON.
- 3) Acknowledge that the completion flag of the counter external input is ON and turn ON the completion acknowledgment flag of the counter external input.
- 4) When the completion acknowledgment of the counter external input is recognized as ON, the completion flag of the counter external input turns OFF.

30.5.9 PWM Output

PWM output is a feature that outputs a pulse with a set output frequency when the set duty turns ON. A maximum of four channels can be set for PWM output, which can be individually set. By connecting SSR to PWM output terminal, analog control for heaters becomes possible. The main features of PWM output are shown in the following table.

Summary of functions	Browse to
Sets the output frequency	 "30.5.9 PWM Output ■ Output frequency" (page 30-90)
Sets the ON Duty	 "30.5.9 PWM Output ■ ON Duty Value" (page 30-91)
Parameter change	 "30.5.9 PWM Output ■ Parameter change request and change completion acknowledgment" (page 30-93)
Checks abnormal status of the output frequency and ON Duty	 "30.5.9 PWM Output ■ Abnormal Status of PWM Output" (page 30-95)
Starts and stops the PWM output	 "30.5.9 PWM Output ■ PWM Output Action Control" (page 30-96)
Checks the status of start and stop PWM output	 "30.5.9 PWM Output ■ PWM Output Status" (page 30-96)
Checks the status of the output terminal	 "30.5.9 PWM Output ■ PWM Output Terminal Status" (page 30-97)

■ Summary

In GP-Pro EX, you can set up the initial value for each parameter. After the system is running, you can change parameters with system variables.

The procedure for setting the PWM output is summarized below.

NOTE

- Some of the settings can be configured in the logic program's I/O driver instructions.
 "31.24 I/O Driver Instructions" (page 31-575)

Setting Up Initial Values

Refer to the setup procedures for GP-Pro EX

Changing After System is Running

- Set the output frequency and the ON duty value.
- Set the parameter under [Request Special I/O Parameter change].
- Under [Special I/O Parameter Change Completed], acknowledge that the parameter has been changed.
- Output the data with [Control Special I/O].
- See "Special I/O state" for acknowledgment.

IMPORTANT

- The [Request Special I/O Parameter Change] and [Special I/O Parameter Change Completed] operations reflect all the CH parameters you change.
- Right after transferring, operations use parameter values set up in GP-Pro EX. Any restarts, which include going off-line, reset, and turning power OFF, use stored system variables as parameters.
- For PWM Output, when changing the Output Frequency and ON duty values, because the timing for changes is random, there may be an instant when the Output frequency or ON duty values are unknown.

■ Output frequency

Set the output frequency. You can use 10Hz to 65kHz for setting the output frequency.

◆ Set Up Process in GP-Pro EX

From [System Settings], select [I/O Driver] and click [PWM Settings] on the [Internal Driver 1] screen.

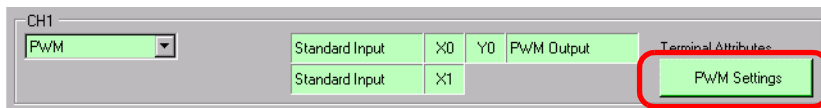

In the [PWM Setting] dialog box, specify the frequency in [Output Frequency].

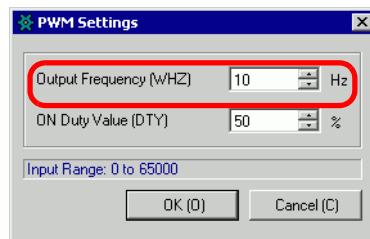

◆ Set Up Process with System Variables

Define the output frequency in the system variable (#L_PWM*_WHZ). The system variable name adjusts to match the CH pulse output to which it's mapped.

■ ON Duty Value

ON duty value is the ON time and OFF time percentage in 1 pulse and sets the ON time in percentage (%).

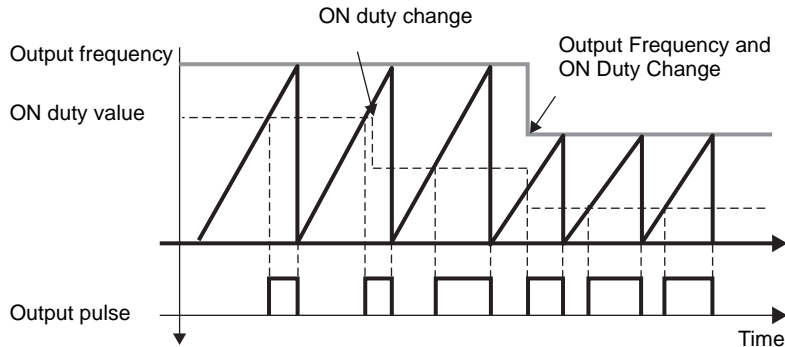

◆ ON duty value effective range

As the output frequency becomes larger, the output waveform set by the ON duty value becomes harder to realize. Therefore, when the output frequency is large, set the setting effective range to correct the output waveform.

◆ How to calculate the effective range

Use the following formulas to calculate the high and low limits of the ON duty effective range.

High limit: $100 - \text{Hardware delay time}^* (\text{microseconds}) \times \text{Output frequency}$

Low limit: $\text{Hardware delay time} (\text{microseconds}) \times \text{Output frequency}$

- * The hardware delay time shows the total of ON→OFF (Time to lower down to 2.4V, which is 10% of 24V) and OFF→ON (Time to rise up to 21.6V, which is 90% of 24V). The hardware delay time of this I/O board is 3 microseconds.

For example, when the hardware delay time is 3 microseconds and the output frequency is 10000Hz

High limit: $100 - 3 \times 10^{-4} \times 10000 = 97 (\%)$

Low limit: $3 \times 10^{-4} \times 10000 = 3 (\%)$

The ON duty effective range, therefore, is 3 to 97%.

IMPORTANT

- Although you can set ON duty to 100% when approximately 3 kHz or less, there is a gap of 1.6 microseconds in each period when it's OFF, despite ON duty being 100%. For example, for 500Hz, one period is 2 milliseconds, and for 1.6 microseconds it's OFF.

◆ Set Up Process in GP-Pro EX

From [System Settings], select [I/O Driver] and click [PWM Settings] on the [Internal Driver 1] screen.

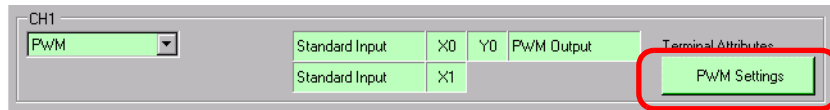

Specify from [ON Duty Value] in the [PWM Settings] dialog box.

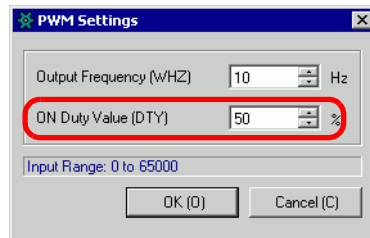
**◆ Set Up Process with System Variables**

Define the ON duty value in the system variable ($\#L_PWM*_DTY$). The system variable name adjusts to match the CH pulse output to which it's mapped.

■ Parameter change request and change completion acknowledgment

Specify the output frequency and the ON duty value under "Request special I/O parameter change."

◆ Setting Method

To set the output frequency and the ON duty value, change the parameter under "Request special I/O parameter change" in the system variable (#L_ExIOSpParmChg).

Then, acknowledge the completion under [Special I/O parameter change completed]. Bit positions of the request flag and completed flag differ depending on the CH to which you allocate PWM output.

1 Change the parameter under "Request special I/O parameter change" (#L_ExIOSpParmChg).

#L_ExIOSpParmChg

H	CH4 Special I/O parameter Changed successfully	CH3 Special I/O parameter Changed successfully	CH2 Special I/O parameter Changed successfully	CH1 Special I/O parameter Changed successfully
L	CH4 Special I/O parameter Change request	CH3 Special I/O parameter Change request	CH2 Special I/O parameter Change request	CH1 Special I/O parameter Change request

Request Special I/O Parameter Change

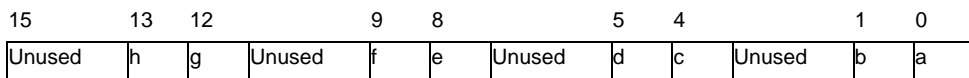

This variable uses the CH specified in the I/O driver settings as the 4-bit configuration information to request the special I/O parameter change.

- a: CH1 special I/O parameter change request
- c: CH2 special I/O parameter change request
- e: CH3 special I/O parameter change request
- g: CH4 special I/O parameter change request

You can also read the previous settings using the Operation bits below.

- b: CH1 Special I/O Parameter Read Request
- d: CH2 Special I/O Parameter Read Request
- f: CH3 Special I/O Parameter Read Request
- h: CH4 Special I/O Parameter Read Request

2 Acknowledge the completion in [Special I/O Parameter Change Completed]. Details of variables differ depending on the CH to which you allocate the counter, as in the following figure.

Special I/O parameter change completed

31	29	28		25	24		21	20		17	16
Unused	h	g	Unused	f	e	Unused	d	c	Unused	b	a

- a: CH1 special I/O parameter changed successfully
- c: CH2 special I/O parameter changed successfully
- e: CH3 special I/O parameter changed successfully
- g: CH4 special I/O parameter changed successfully

You can also read the previous settings using the watch bits below.

- b: CH1 Special I/O Parameter read successfully
- d: CH2 Special I/O Parameter read successfully
- f: CH3 Special I/O Parameter read successfully
- h: CH4 Special I/O Parameter read successfully

3 The figure below shows the flag timing chart for the special I/O parameter change request and completion.

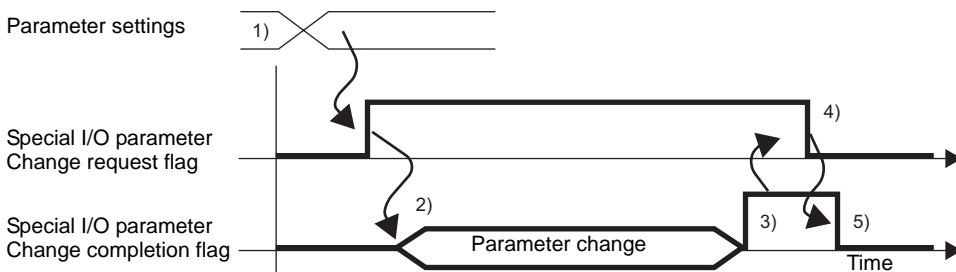

- 1) Set the output frequency and the ON duty value.
- 2) Turn ON the request flag for the special I/O parameter change to change the parameter.
- 3) Once the parameter is changed, the completion flag of the special I/O parameter change turns ON.
- 4) Acknowledge that the completion flag of the special I/O parameter change is ON and turn OFF the request flag for the special I/O parameter change.
- 5) When the request flag for the special I/O parameter is recognized as OFF, the completion flag of the special I/O parameter change turns OFF.

■ Abnormal Status of PWM Output

Displays the PWM Output output frequency or ON duty error status. When error code 101 (parameter error) is stored in system variable #L_IOSpParamErr, you can verify the error status using the value in system variable (#L_ExIOSpParmErr). The watch bit will differ, depending on the CH to which you allocate the PWM output.

IMPORTANT • When changing Special I/O parameters, and the ON duty value is set outside the valid range, operations continue by using parameters set up to that point. However, since an invalid value is stored in the system, make sure you change it to a valid value. If you restart the LT with invalid values (go off-line, reset, or turn the power OFF), operations will use initial parameter values set up in GP-Pro EX.

#L_ExIOSpParmErr

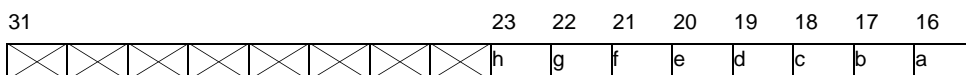
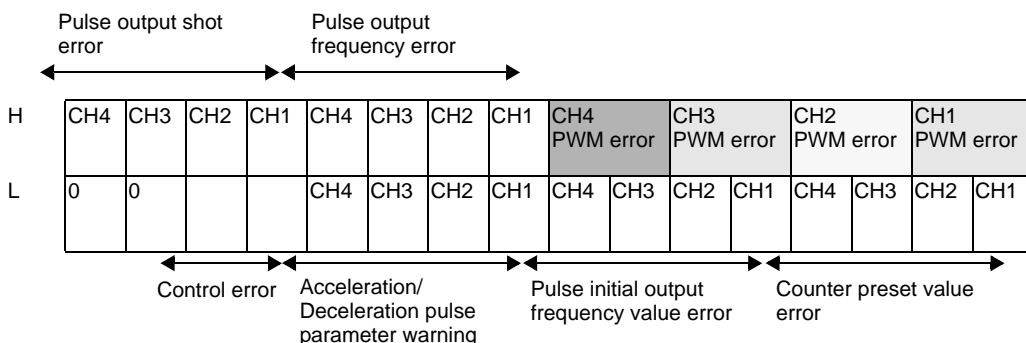

- a: CH1 PWM output frequency error 1: Frequency error, 0: Normal
- b: CH1 PWM output ON duty error 1: ON duty error, 0: Normal
- c: CH2 PWM output frequency error 1: Frequency error, 0: Normal
- d: CH2 PWM output ON duty error 1: ON duty error, 0: Normal
- e: CH3 PWM output frequency error 1: Frequency error, 0: Normal
- f: CH3 PWM output ON duty error 1: ON duty error, 0: Normal
- g: CH4 PWM output frequency error 1: Frequency error, 0: Normal
- h: CH4 PWM output ON duty error 1: ON duty error, 0: Normal

■ PWM Output Action Control

Use this function to start and stop the PWM output. Turn ON the PWM output under the CH special I/O control under the system variable (#L_ExIOSpCtrl) to start and turn OFF the flag to stop the output. The Operation bit will differ, depending on the CH to which you allocate the PWM output.

#L_ExIOSpCtrl

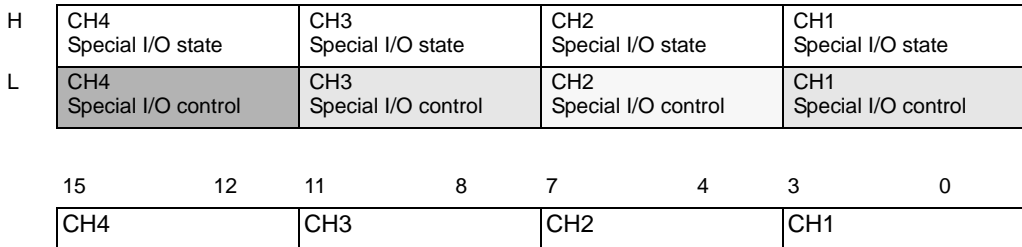

Turn ON the start bit of the CH (0 bit) to start and turn it OFF to stop the output.

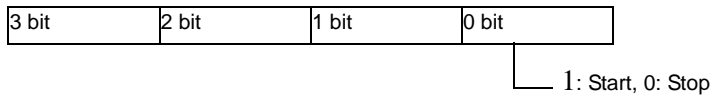

■ PWM Output Status

This function shows the PWM output state. The PWM output flag shows the output status under the CH special I/O state under the system variable (#L_ExIOSpCtrl). If the flag is ON, the output is ON. The watch bit will differ, depending on the CH to which you allocate the PWM output.

#L_ExIOSpCtrl

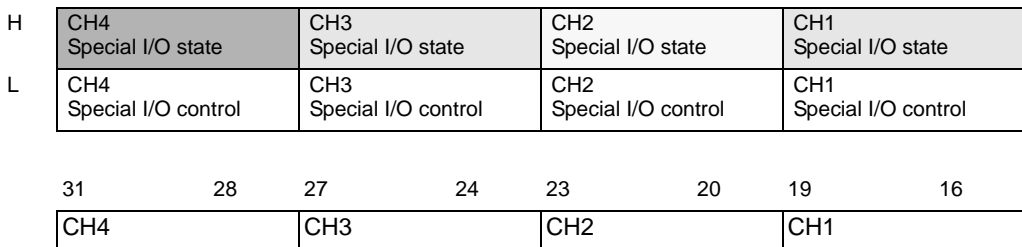

If the start bit of the CH (0 bit) is 1, the output is ON. If it is 0, the output is OFF.

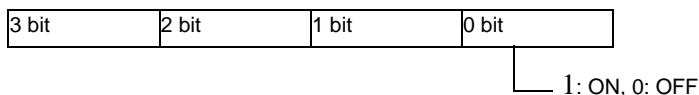

■ PWM Output Terminal Status

It shows the PWM output state in the output terminal.







#L_ExIOSpOut

H	0	0	0	0	0	0	0	0	0	0	0	0	0	0	0	0
L	CH4 information				CH3 information				CH2 information				CH1 information			
	15			12			8			4			0			
	Unused		d	Unused		c	Unused		b	Unused		a				

- a: CH1 output state 1: Output, 0: Not output
- b: CH2 output state 1: Output, 0: Not output
- c: CH3 output state 1: Output, 0: Not output
- d: CH4 output state 1: Output, 0: Not output

30.5.10 Normal Pulse Output

Pulse output includes normal pulse output, which outputs a frequency set to a predetermined pulse-output number, and acceleration/deceleration pulse output, which gradually increases the frequency up to a set pulse-output value. Up to four normal pulse outputs can be used. A positioning-control motor can be driven by connecting a CW or CCW stepping motor or connecting a CW or CCW servo-motor amplifier. The main features of normal pulse output are shown in the following table.

Summary of functions	Browse to
Sets the output frequency	 "30.5.9 PWM Output ■ Output frequency" (page 30-90)
Sets the output pulse count	 "30.5.10 Normal Pulse Output ■ Output Pulse Number" (page 30-100)
Parameter change	 "30.5.9 PWM Output ■ Parameter change request and change completion acknowledgment" (page 30-93)
Checks abnormal status of the output frequency and output pulses.	 "30.5.10 Normal Pulse Output ■ Abnormal Status of Normal Pulse Output" (page 30-103)
Starts and stops the normal pulse output	 "30.5.10 Normal Pulse Output ■ Normal Pulse Output Action Control" (page 30-104)
Checks the start and stop status of the normal pulse output	 "30.5.10 Normal Pulse Output ■ Output State Status and Output Completed Status of Normal Pulse Output" (page 30-104)
Checks the status of the output terminal	 "30.5.10 Normal Pulse Output ■ Normal Pulse Output Terminal Status" (page 30-105)

◆ Summary

In GP-Pro EX, you can set up the initial value for each parameter. After the system is running, you can change parameters with system variables.

The procedure for setting the pulse output is summarized below.

NOTE

- Some of the settings can be configured in the logic program's I/O driver instructions.

 "31.24 I/O Driver Instructions" (page 31-575)

Setting Up Initial Values

Refer to the setup procedures for GP-Pro EX

Changing After System is Running

- Set the output frequency and the Output pulse count.
- Change the parameter under [Request Special I/O Parameter Change].
- Under [Special I/O Parameter Change Completed], acknowledge that the parameter has been changed.
- Output the data with [Control Special I/O].
- See "Special I/O state" for acknowledgment.

IMPORTANT

- The [Request Special I/O Parameter Change] and [Special I/O Parameter Change Completed] operations reflect all the CH parameters you change.
- The pulse output starts on OFF and outputs once at ON->OFF. The Output pulse count is updated every ON->OFF. When you forcibly stop the pulse output, the output stops no matter what state the pulse is in. Therefore, the pulse output generated during the forced stop might not be counted in some cases.
- Pulse outputs have a limit to the output frequency and pulse count. For details, see "30.5.14 Restrictions" (page 30-129).
- Right after transferring, operations use parameter values set up in GP-Pro EX. Any restarts, which include going off-line, reset, and turning power OFF, use stored system variables as parameters.

■ **Output frequency**

Specify the output frequency. You can use 10Hz to 65kHz for setting the output frequency.

◆ **Set Up Process in GP-Pro EX**

In [System Settings], select [I/O Driver] and click [Pulse Settings] on the [Internal Driver 1] screen.

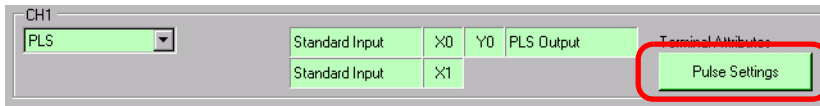

Specify the [Output Frequency] in the [Pulse Settings] dialog box.

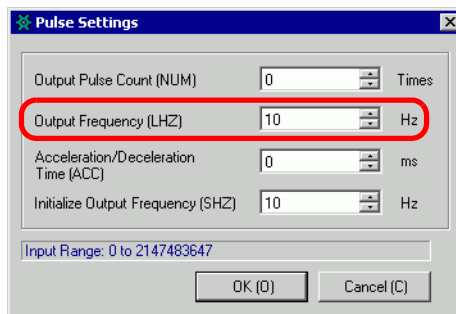

◆ **Set Up Process with System Variables**

Define the output frequency in the system variable (#L_PLS*_LHZ). The system variable name adjusts to match the CH pulse output to which it's mapped.

■ Output Pulse Number

Specify the Output pulse count. You can use 0 to 2147483647 for setting the Output pulse count.

IMPORTANT

- If you change the pulse shot to a value smaller than the current value during the pulse output, the output stops.

◆ Set Up Process in GP-Pro EX

In [System Settings], select [I/O Driver] and click [Pulse Settings] on the [Internal Driver 1] screen.

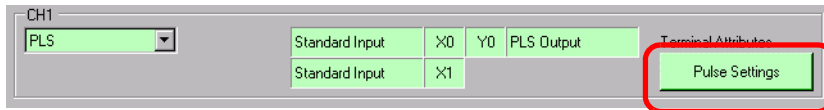

Specify the [Output Pulse Number] in the [Pulse Settings] dialog box.

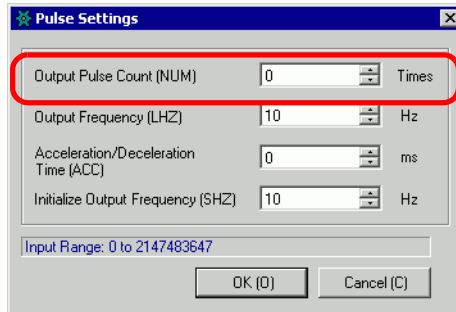

◆ Set Up Process with System Variables

Output pulses are defined in the system variable (#L_PLS*_NUM). The system variable name adjusts to match the CH pulse output to which it's mapped.

■ Parameter change request and change completion acknowledgment

Specify the output frequency and the Output pulse count under "Request special I/O parameter change."

◆ Setting Method

To set the output frequency and the Output pulse count, change the parameter under "Request special I/O parameter change" in the system variable (#L_ExIOSpParmChg).

Then, acknowledge the completion under [Special I/O parameter change completed].

Depending on the CH to which you allocate the pulse output, the request flag and completion flag will have different bit positions.

1 Change the parameter under "Request special I/O parameter change" (#L_ExIOSpParmChg).

#L_ExIOSpParmChg

H	CH4 Special I/O parameter Changed successfully	CH3 Special I/O parameter Changed successfully	CH2 Special I/O parameter Changed successfully	CH1 Special I/O parameter Changed successfully
L	CH4 Special I/O parameter Change request	CH3 Special I/O parameter Change request	CH2 Special I/O parameter Change request	CH1 Special I/O parameter Change request

Request Special I/O Parameter Change

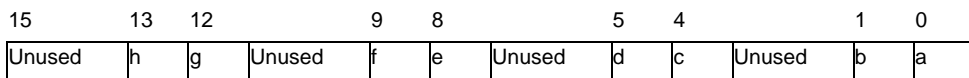

This variable uses the CH specified in the I/O driver settings as the 4-bit configuration information to request the special I/O parameter change.

- a: CH1 special I/O parameter change request
- c: CH2 special I/O parameter change request
- e: CH3 special I/O parameter change request
- g: CH4 special I/O parameter change request

You can also read the previous settings using the Operation bits below.

- b: CH1 Special I/O Parameter Read Request
- d: CH2 Special I/O Parameter Read Request
- f: CH3 Special I/O Parameter Read Request
- h: CH4 Special I/O Parameter Read Request

2 Acknowledge the completion in [Special I/O Parameter Change Completed]. Regarding the variable, the watch bit will differ, depending on the CH to which you allocate the pulse output, as shown below.

Special I/O parameter change completed

31	29	28		25	24		21	20		17	16
Unused	h	g	Unused	f	e	Unused	d	c	Unused	b	a

- a: CH1 special I/O parameter changed successfully
- c: CH2 special I/O parameter changed successfully
- e: CH3 special I/O parameter changed successfully
- g: CH4 special I/O parameter changed successfully

You can also read the previous settings using the watch bits below.

- b: CH1 Special I/O Parameter read successfully
- d: CH2 Special I/O Parameter read successfully
- f: CH3 Special I/O Parameter read successfully
- h: CH4 Special I/O Parameter read successfully

3 The figure below shows the flag timing chart for the special I/O parameter change request and completion.

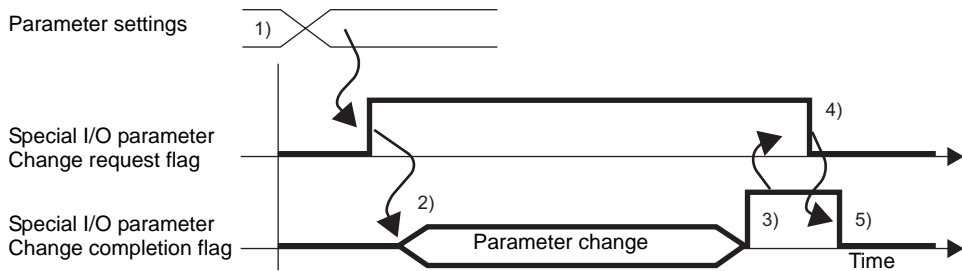

- 1) Set the output frequency and the Output pulse count.
- 2) Turn ON the request flag for the special I/O parameter change to change the parameter.
- 3) Once the parameter is changed, the completion flag turns ON.
- 4) Acknowledge that the completion flag is ON and turn the request flag OFF.
- 5) When the request flag is recognized as OFF, the completion flag turns OFF.

■ Abnormal Status of Normal Pulse Output

This function shows the error status of pulse outputs such as in the output pulse frequency and output pulse shot. If the system variable #L_IOStatus0 has the error code 101 or 103, you can acknowledge the error status from the system variable #L_ExIOSpParmErr. The watch bit will differ, depending on the CH to which you allocate the pulse output.

IMPORTANT • When changing Special I/O parameters, and the defined value is outside the valid range, operations continue by using parameters set up to that point. However, since an invalid value is stored in the system, make sure you change it to a valid value. If you restart the LT with invalid values (go off-line, reset, or turn the power OFF), operations will use initial parameter values set up in GP-Pro EX.

#L_ExIOSpParmErr

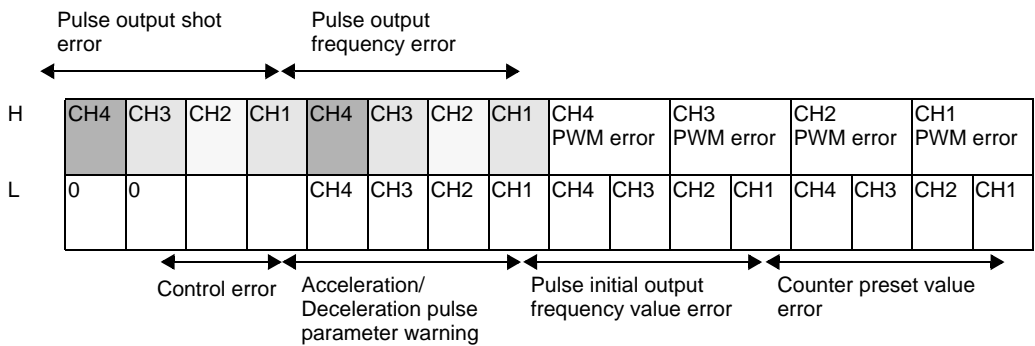

Pulse output frequency error

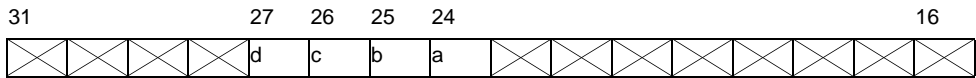

- a: CH1 pulse output frequency error 1: Frequency error, 0: Normal
- b: CH2 pulse output frequency error 1: Frequency error, 0: Normal
- c: CH3 pulse output frequency error 1: Frequency error, 0: Normal
- d: CH4 pulse output frequency error 1: Frequency error, 0: Normal

Pulse output shot error

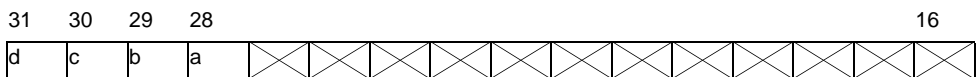

- a: CH1 pulse output shot error 1: Pulse shot error, 0: Normal
- b: CH2 pulse output shot error 1: Pulse shot error, 0: Normal
- c: CH3 pulse output shot error 1: Pulse shot error, 0: Normal
- d: CH4 pulse output shot error 1: Pulse shot error, 0: Normal

Control error

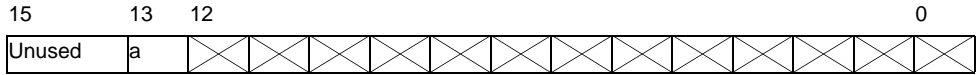

a: Pulse output control error

1: Abnormal Frequency Limit Occurred; 0: Normal

■ Normal Pulse Output Action Control

This function shows to start and stop the pulse output. Turn ON the pulse output flag under the CH special I/O control in the system variable (#L_ExIOSpCtrl) to start and turn it OFF to stop the output. The Operation bit will differ, depending on the CH to which you allocate the pulse output.

#L_ExIOSpCtrl

H	CH4 Special I/O state	CH3 Special I/O state	CH2 Special I/O state	CH1 Special I/O state
L	CH4 Special I/O control	CH3 Special I/O control	CH2 Special I/O control	CH1 Special I/O control

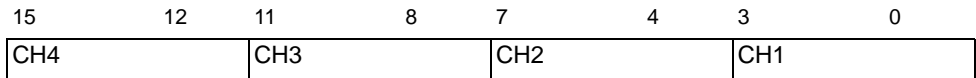

Turn ON the start bit of the CH (0 bit) to start and turn it OFF to stop the output.

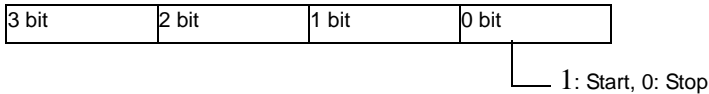

■ Output State Status and Output Completed Status of Normal Pulse Output

This function shows the normal pulse output state and completion. The pulse output flag shows the output state under the CH special I/O state in the system variable (#L_ExIOSpCtrl). If the flag is ON, the output is ON. If the flag is off the output is OFF. Furthermore, if the completion flag of the setting pulse shot output is ON, the output has been completed. If the flag is OFF, the output has not been completed. The watch bit will differ, depending on the CH to which you allocate the pulse output.

#L_ExIOSpCtrl

H	CH4 Special I/O state	CH3 Special I/O state	CH2 Special I/O state	CH1 Special I/O state
L	CH4 Special I/O control	CH3 Special I/O control	CH2 Special I/O control	CH1 Special I/O control

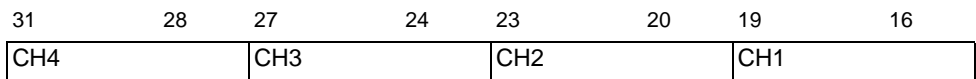

If the start bit of the CH (0 bit) is 1, the output is ON. If it is 0, the output is OFF. Furthermore, if the 2nd bit is 1, the set pulse shot has been output successfully.

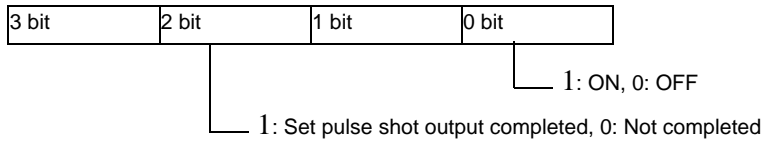

■ Normal Pulse Output Terminal Status

This function shows the pulse output state in the output terminal.









#L_ExIOSpOut

H	0	0	0	0	0	0	0	0	0	0	0	0	0	0	0	0																
L	CH4 information				CH3 information				CH2 information				CH1 information																			
	15				12				8				4				0															
	Unused				d				Unused				c				Unused				b				Unused				a			

- | | |
|---------------------|--------------------------|
| a: CH1 output state | 1: Output, 0: Not output |
| b: CH2 output state | 1: Output, 0: Not output |
| c: CH3 output state | 1: Output, 0: Not output |
| d: CH4 output state | 1: Output, 0: Not output |

30.5.11 Acceleration/Deceleration Pulse Output

Pulse output includes normal pulse output, which outputs a frequency set to a predetermined pulse output number, and acceleration/deceleration pulse output, which gradually increases the frequency up to a set pulse-output value. Up to four accelerating pulse outputs can be used. The main features of accelerating pulse output are shown in the following table.

Summary of functions	Browse to
Sets the constant output frequency	 "30.5.9 PWM Output ■ Output frequency" (page 30-90)
Setting the initial output frequency	 "30.5.11 Acceleration/Deceleration Pulse Output ■ Initial Output Frequency" (page 30-108)
Sets the time until the constant output frequency	 "30.5.11 Acceleration/Deceleration Pulse Output ■ Acceleration/Deceleration Time" (page 30-109)
Creates the acceleration/deceleration table	 "30.5.11 Acceleration/Deceleration Pulse Output ■ Request to Create Accelerating Table and Checking Whether Creation is Complete" (page 30-110)
Checks abnormal status of each parameter	 "30.5.11 Acceleration/Deceleration Pulse Output ■ Abnormal Status of Acceleration/Deceleration Pulse Output" (page 30-116)
Starts and stops the acceleration/deceleration pulse output	 "30.5.11 Acceleration/Deceleration Pulse Output ■ Accelerating Pulse Output Action Control" (page 30-113)
Checks the start and stop status of the acceleration/deceleration pulse output	 "30.5.11 Acceleration/Deceleration Pulse Output ■ Output State Status and Output Complete Status of Acceleration/Deceleration Pulse Output" (page 30-115)
Checks the status of the output terminal	 "30.5.11 Acceleration/Deceleration Pulse Output ■ Acceleration/Deceleration Pulse Output Terminal Status" (page 30-121)
Number of output pulses	 "30.5.10 Normal Pulse Output ■ Output Pulse Number" (page 30-100)

■ Summary

In GP-Pro EX, you can set up the initial value for each parameter. After the system is running, you can change parameters with system variables.

The procedure for setting the acceleration/deceleration pulse output is summarized below.

NOTE

- Some of the settings can be configured in the logic program's I/O driver instructions.
 "31.24 I/O Driver Instructions" (page 31-575)

Setting Up Initial Values

Refer to the setup procedures for GP-Pro EX

Changing After System is Running

1. Set the output frequency, Output pulse count, initial output frequency, and acceleration/ deceleration time.
2. Set the parameter [Create Acceleration/Deceleration table request].
3. Under [Create Acceleration/Deceleration table complete], acknowledge that the parameter has been changed.
4. Under [Control Special I/O], turn ON the acceleration/deceleration bit.
5. Output the data with [Control Special I/O].
6. See "Special I/O state" for acknowledgment.

IMPORTANT

- Acceleration and deceleration pulse outputs have a limit to the output frequency and pulse count. For details, see "30.5.14 Restrictions" (page 30-129).

■ Acceleration/Deceleration Pulse Output

Acceleration/Deceleration pulse output makes the output frequency - time curve to reach the set pulse shot less steep.

The output frequency in the pulse output increases from the initial output frequency (F_0) to the normal output frequency (F) in the acceleration/deceleration time (T) gradually through 10 phases saving the same intervals. Then, it outputs the shot of the total pulse shot minus the pulse shot necessary for deceleration and decelerates through 10 phases as so in acceleration.

In addition to setting the output frequency (F) and the Output pulse count for the normal pulse output, set the initial output frequency (F_0) and the acceleration/deceleration time (T).

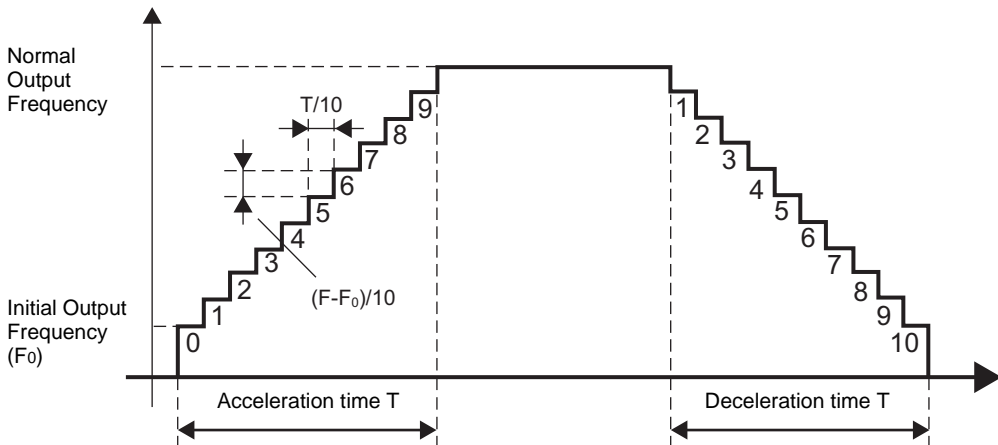

IMPORTANT

- The acceleration/deceleration pulse output starts on OFF and outputs once at ON→OFF. The Output pulse count is updated every ON→OFF. When you forcibly stop the pulse output, the output stops no matter what state the pulse is in. Therefore, the pulse output generated during the forced stop might not be counted in some cases.
- When you turn ON the request flag for the acceleration/deceleration pulse table from multiple CHs simultaneously, generally, the request from the CH with the smallest number is processed first. However, since the acceleration/deceleration table is created for the CH whose request is detected first, the table might be created in such order as 3→4→1→2, depending on the timing.

■ Output frequency

This function sets the pulse output frequency. You can use 10Hz to 65kHz for setting the output frequency. If you use the pulse output in multiple CHs, the total output frequency should not exceed 260kHz.

For pulse outputs, there is a limit to the maximum output frequency depending on the number of CH used.

☞ "30.5.14 Restrictions" (page 30-129)

Furthermore, you can set 2 types of output frequencies of the aforementioned acceleration/deceleration pulse and for the normal pulse in one CH. However, the total output frequency check is based on the normal frequency of acceleration/deceleration pulse or the normal pulse output frequency, whichever is larger.

■ Initial Output Frequency

This function sets the output frequency for when the pulse output starts and stops. You can use 0 and 10Hz to 65kHz for setting the initial output frequency.

◆ Set Up Process in GP-Pro EX

In [System Settings], select [I/O Driver] and click [Pulse Settings] on the [Internal Driver 1] screen.

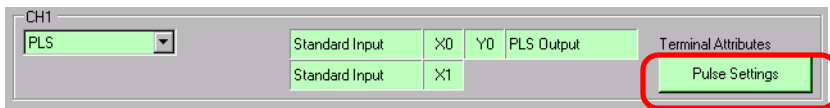

Specify the [Initial Output Frequency] in the [Pulse Settings] dialog box.

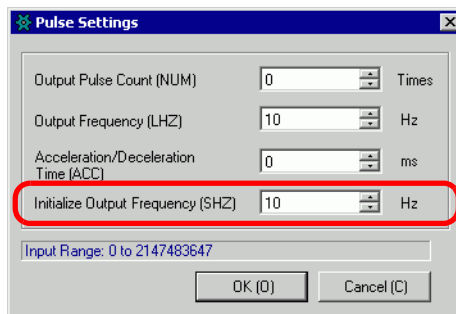

◆ Set Up Process with System Variables

Define the initial output frequency in the system variable (#L_PLS*_SHZ). The system variable name adjusts to match the CH pulse output to which it's mapped.

■ Acceleration/Deceleration Time

This function sets the time where the output pulse changes the initial output frequency to the normal output frequency. You can use 0 milliseconds to 65535 milliseconds for setting the acceleration/deceleration time.

◆ Set Up Process in GP-Pro EX

In [System Settings], select [I/O Driver] and click [Pulse Settings] on the [Internal Driver 1] screen.

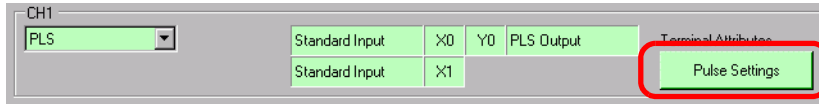

Specify the [Acceleration/Deceleration Time] in the [Pulse Settings] dialog box.

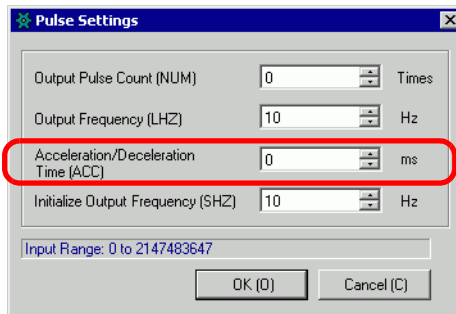

◆ Set Up Process with System Variables

Define the acceleration/deceleration time in the system variable (#L_PLS*_ACC). The system variable name adjusts to match the CH pulse output to which it's mapped.

■ Request to Create Accelerating Table and Checking Whether Creation is Complete

Specify the output frequency, output pulse count, initial output frequency, and acceleration/deceleration time to run the "Create Acceleration/Deceleration table request" and create the acceleration/deceleration table.

Then, acknowledge the completion under [Create table request complete]. Depending on the CH to which you allocate the pulse output, the request flag and completion flag will have different bit positions.

Furthermore, to delete the acceleration/deceleration table, set the initial frequency and the acceleration/deceleration both to 0. The table is deleted when you create the acceleration/deceleration table.

◆ Setting Method

- 1 Using the "Request table creation" in the system variable (#L_ExIOAccelPlsTbl), change the acceleration/deceleration table.

#L_ExIOAccelPlsTbl

H	0	0	0	0	CH4 Table Created successfully	CH3 Table Created successfully	CH2 Table Created successfully	CH1 Table Created successfully	0	0	0	0
L	0	0	0	0	CH4 Table Creation requested	CH3 Table Creation requested	CH2 Table Creation requested	CH1 Table Creation requested	0	0	0	0

Acceleration/Deceleration table creation

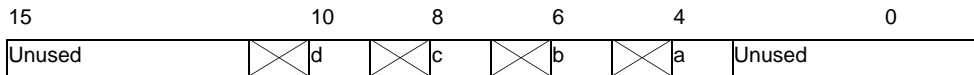

- a: CH1 acceleration/deceleration pulse table creation request 1: Creation requested
- b: CH2 acceleration/deceleration pulse table creation request 1: Creation requested
- c: CH3 acceleration/deceleration pulse table creation request 1: Creation requested
- d: CH4 acceleration/deceleration pulse table creation request 1: Creation requested

2 Regarding the details of the variable allocated in [Create Acceleration/Deceleration table complete], the watch bit will differ, depending on the CH to which you allocate the pulse output, as shown below.

31	26			24		22		20		16
Unused	h	g	f	e	d	c	b	a	Unused	

- a: CH1 acceleration/ deceleration pulse table created successfully 1: Created successfully
- b: CH1 acceleration/deceleration pulse table available/not available 1: Table available for output
0: Table not available (output not available)
- c: CH2 acceleration/ deceleration pulse table created successfully 1: Created successfully
- d: CH2 acceleration/deceleration pulse table available/not available 0: Table available for output
0: Table not available (output not available)
- e: CH3 acceleration/ deceleration pulse table created successfully 1: Created successfully
- f: CH3 acceleration/deceleration pulse table available/not available 1: Table available for output
0: Table not available (output not available)
- g: CH4 acceleration/ deceleration pulse table created successfully 1: Created successfully
- h: CH4 acceleration/deceleration pulse table available/not available 1: Table available for output
0: Table not available (output not available)

3 The following shows the flag timing chart for the creation request of acceleration/ deceleration pulse table and completion.

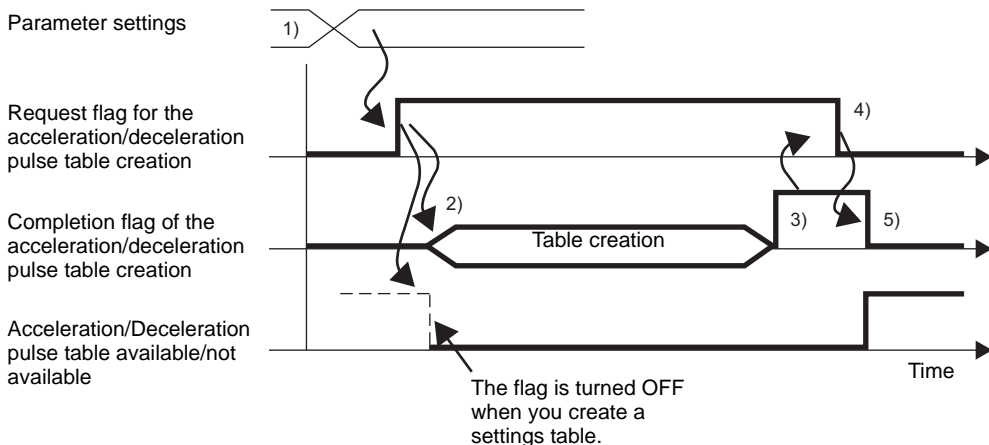

- 1) Set the output frequency, Output pulse count, initial output frequency, and acceleration/ deceleration time.
- 2) Turn ON the request flag for the acceleration/deceleration table creation to create the table.
- 3) Once the table is created, the completion flag turns ON.
- 4) Acknowledge that the completion flag is ON and turn the request flag OFF.
- 5) When the request flag is recognized as OFF, the completion flag turns OFF.

◆ **Notes on creating the table**

While the acceleration/deceleration pulse output is ON ("Request acceleration/deceleration pulse output" is ON), no request for creating acceleration/deceleration pulse table is accepted.

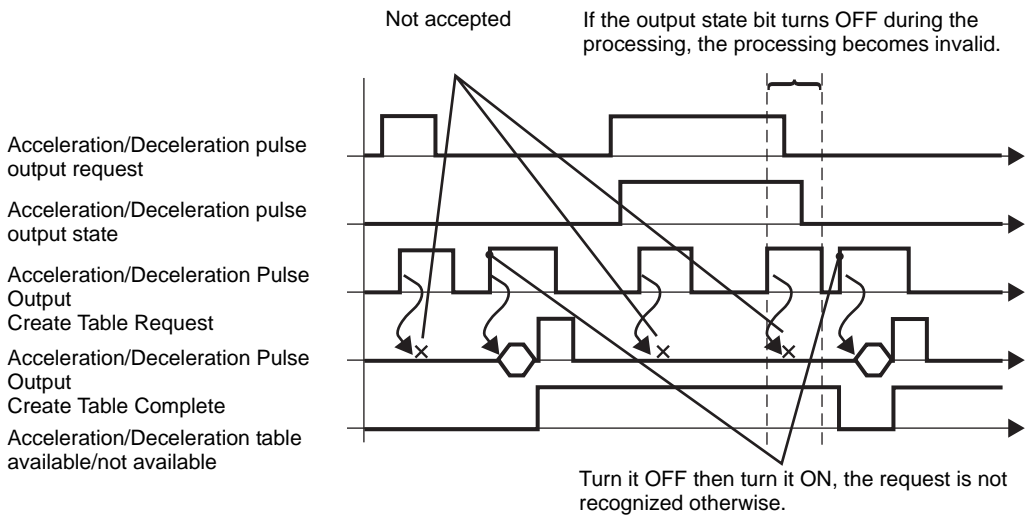

■ Accelerating Pulse Output Action Control

Use this function to start and stop the acceleration/deceleration pulse output. Enable the acceleration/deceleration settings and turn ON the pulse output flag under the CH special I/O control in the system variable (#L_ExIOSpCtrl) to start, and turn OFF the pulse output flag to stop the output. The Operation bit will differ, depending on the CH to which you allocate the pulse output.

IMPORTANT

- If you enable the acceleration/deceleration setting flag after the acceleration/deceleration pulse output starts, the acceleration/deceleration pulse is not output and the normal pulse output remains. If you enable the acceleration/deceleration pulse setting flag and start the pulse output simultaneously, the acceleration/deceleration pulse output is prioritized.

◆ Setting Method

- 1 Regarding the details in [Control Special I/O], the Operation bit will differ, depending on the CH to which you allocate the pulse output, as shown below.

#L_ExIOSpCtrl

H	CH4 Special I/O state	CH3 Special I/O state	CH2 Special I/O state	CH1 Special I/O state
L	CH4 Special I/O control	CH3 Special I/O control	CH2 Special I/O control	CH1 Special I/O control

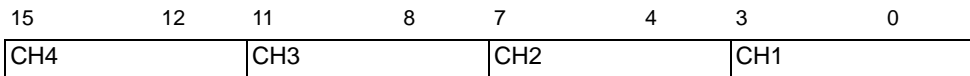

The first bit in each CH is an accelerating pulse setting bit. To start acceleration/deceleration pulse output, first turn ON this bit.

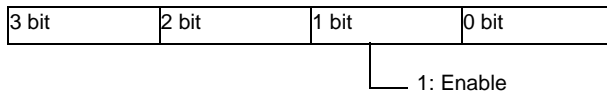

- 2 The pulse output start and stop have different Operation bits, depending on the CH to which you allocate the pulse output.

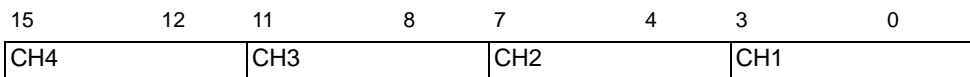

Turn ON the start bit of the CH (0 bit) to start and turn it OFF to stop the output.

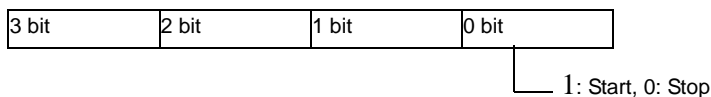

◆ **Notes on the pulse output**

While you are creating the acceleration/deceleration pulse table, no pulse is output as shown below.

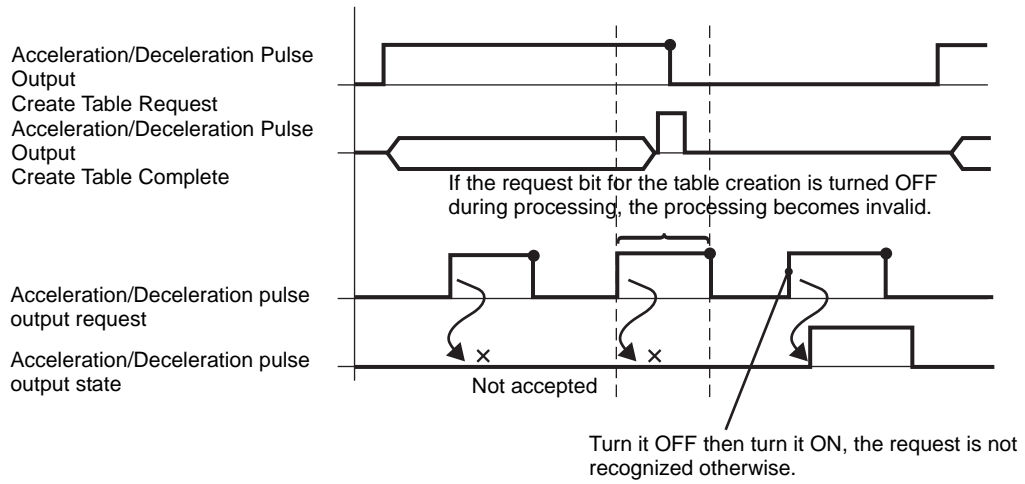

■ Output State Status and Output Complete Status of Acceleration/Deceleration Pulse Output

This function shows the output and completion of the acceleration/deceleration pulse output. The enable flag and pulse output flag show the acceleration/deceleration pulse output state under the CH special I/O state in the system variable (#L_ExIOSpCtrl). If the flags are ON, the output is ON. If the pulse output flag is OFF, the output is OFF.

Furthermore, if the completion flag of the setting pulse shot output is ON, the output has been completed. If the flag is OFF, the output has not been completed. The watch bit will differ, depending on the CH to which you allocate the pulse output.

◆ Setting Method

- Regarding the details in [Special I/O State], the watch bit will differ, depending on the CH to which you allocate the pulse output, as shown below.

#L_ExIOSpCtrl

H	CH4 Special I/O state	CH3 Special I/O state	CH2 Special I/O state	CH1 Special I/O state
L	CH4 Special I/O control	CH3 Special I/O control	CH2 Special I/O control	CH1 Special I/O control

31	28	27	24	23	20	19	16
CH4		CH3		CH2		CH1	

If the start bit of the CH (0 bit) is 1, the output is ON. If it is 0, the output is OFF. Furthermore, if the 2nd bit is 1, the set pulse shot has been output successfully.

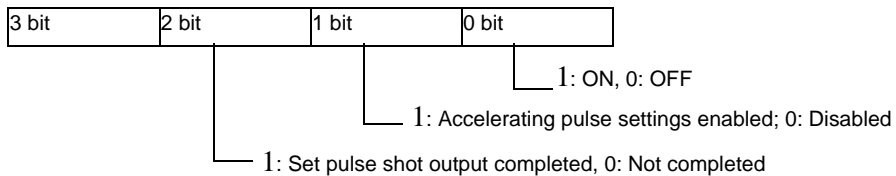

■ Abnormal Status of Acceleration/Deceleration Pulse Output

This function shows any error status in the output frequency and the initial output frequency during the pulse output. If the system variable (#L_IOSStatus0) shows the error code 101, you can acknowledge the error status from the system variable (#L_ExIOSpParmErr) value. The watch bit will differ, depending on the CH to which you allocate the pulse output.

IMPORTANT • When changing Special I/O parameters, and the defined value is outside the valid range, operations continue by using parameters set up to that point. However, since an invalid value is stored in the system, make sure you change it to a valid value. If you restart the LT with invalid values (go off-line, reset, or turn the power OFF), operations will use initial parameter values set up in GP-Pro EX.

#L_ExIOSpParmErr

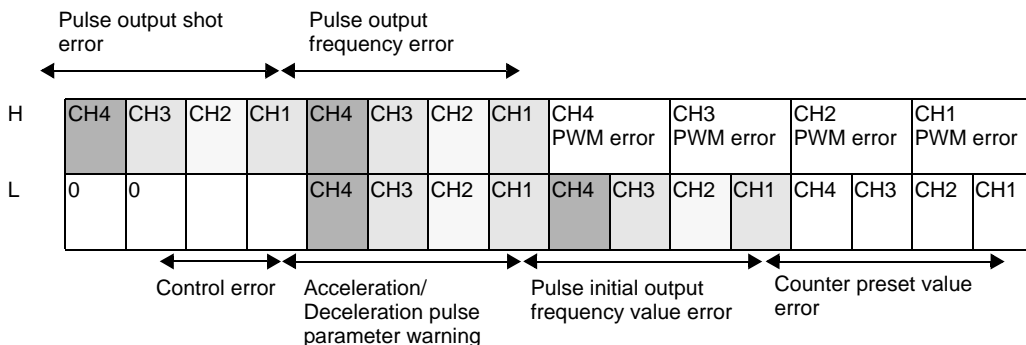

Pulse output frequency error

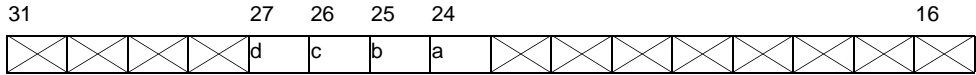

- a: CH1 pulse output frequency error 1: Frequency error, 0: Normal
- b: CH2 pulse output frequency error 1: Frequency error, 0: Normal
- c: CH3 pulse output frequency error 1: Frequency error, 0: Normal
- d: CH4 pulse output frequency error 1: Frequency error, 0: Normal

Pulse output shot error

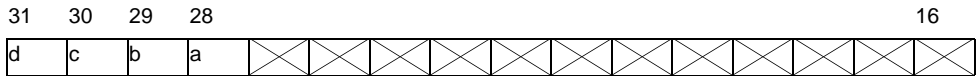

- a: CH1 pulse output shot error 1: Pulse shot error, 0: Normal
- b: CH2 pulse output shot error 1: Pulse shot error, 0: Normal
- c: CH3 pulse output shot error 1: Pulse shot error, 0: Normal
- d: CH4 pulse output shot error 1: Pulse shot error, 0: Normal

Pulse initial output frequency value error

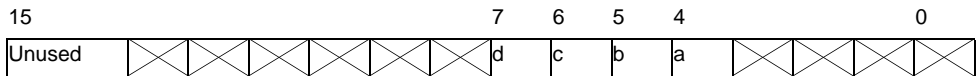

- a: CH1 pulse initial output frequency value error 1: Initial output frequency error
0: Normal
- b: CH2 pulse initial output frequency value error 1: Initial output frequency error
0: Normal
- c: CH3 pulse initial output frequency value error 1: Initial output frequency error
0: Normal
- d: CH4 pulse initial output frequency value error 1: Initial output frequency error
0: Normal

Acceleration/Deceleration pulse parameter warning

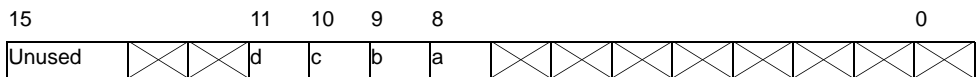

- a:CH1 acceleration/deceleration pulse parameter warning 1:Acceleration/deceleration warning
0: Normal
- b:CH2 acceleration/deceleration pulse parameter warning 1:Acceleration/deceleration warning
0: Normal
- c:CH3 acceleration/deceleration pulse parameter warning 1:Acceleration/deceleration warning
0: Normal
- d:CH4 acceleration/deceleration pulse parameter warning acceleration/
deceleration warning 1:Acceleration/deceleration warning
0: Normal

Control error

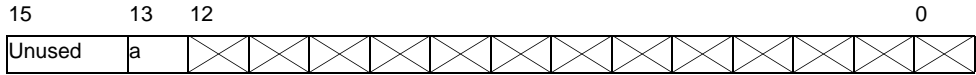

a: Pulse output control error

1: Abnormal Frequency Limit Occurred; 0: Normal

◆ Actions Upon Acceleration/Deceleration Pulse Error

In the cases below, no pulse is output. (Acceleration/Deceleration table available/not available flag does not turn ON.)

- The output terminal does not have the pulse output settings.
- The specified CH has already output the Output pulse count.
- (Normal) The output frequency exceeds 65kHz*1
- (Normal) The initial output frequency is larger than the output frequency.

In the cases below, the output pulse does not depend on the setting parameter.

- The total Output pulse count is too small. (If the total is smaller than 21 (normal), deceleration starts before acceleration reaches the output frequency. Furthermore, the Output pulse count during acceleration/deceleration is 1 pulse at each phase.) *2
- The acceleration/deceleration time is too short. (Since 1 pulse is always output at each phase during acceleration/deceleration, the acceleration/deceleration time does not match the setting value.) *2
- The acceleration/deceleration time is too short. (Since 1 pulse is always output at each phase during acceleration/deceleration, the acceleration/deceleration time does not match the setting value.) *2

*1 The pulse output frequency error flag in special I/O parameter error turns ON.

*2 The acceleration/deceleration pulse meter warning flag in the special I/O parameter error turns ON. (The acceleration/deceleration pulse flag turns ON, and the acceleration/deceleration pulse output is available.)

◆ How to calculate the frequency at each phase during acceleration/deceleration

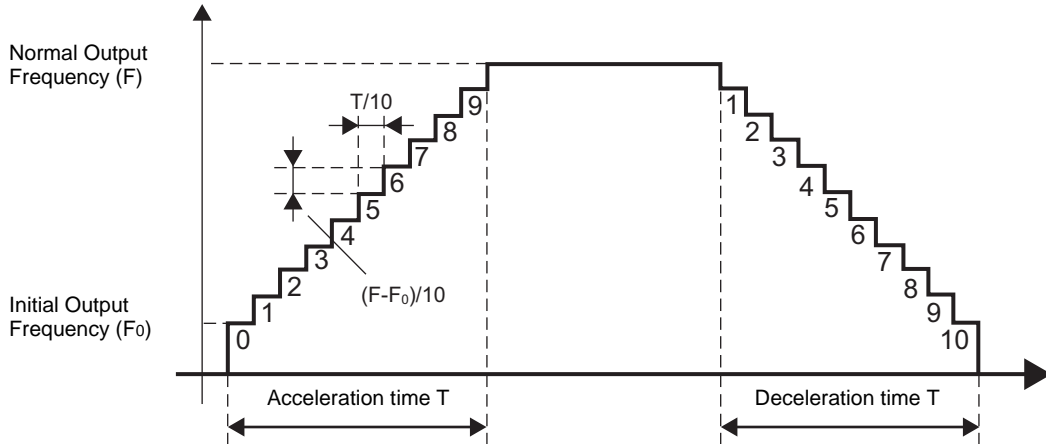

Calculate the frequency for each phase.

Output frequency for n phase = Initial frequency + (Normal output frequency – Initial output frequency)/10 phases* (n phase - 1 phase)

Truncate fractional values for the n phase output frequency.

Calculate the pulse shot for each phase.

Output pulse count for n phase = (Acceleration/Deceleration time/10 phases) * (Output frequency for n phase/1000 milliseconds)

Truncate fractional values for the n phase output pulse count.

At least 1 pulse is output. If the pulse shot is 0, use 1 for the pulse shot.

Output pulse count necessary for acceleration/deceleration pulse output = (Output pulse count for the 1st phase + ... + Output pulse count for the 10th phase) * 2 + 1 pulse

If this Output pulse count is larger than what you set, the acceleration/deceleration pulse parameter warning warns you acceleration/deceleration is excessive.

Calculate the acceleration/deceleration time for each phase

Acceleration/Deceleration time for n phase = Output pulse count for n phase * (1000 milliseconds/Output frequency for n phase)

Truncate fractional values for the n phase acceleration/deceleration time.

Acceleration/Deceleration time necessary for acceleration/deceleration pulse output = Acceleration/Deceleration time for 1st phase + ... + Acceleration/Deceleration time for the 10th phase

If this acceleration/deceleration time is longer than what you set, the acceleration/deceleration pulse parameter warning warns you acceleration/deceleration is insufficient.

For example, based on the aforementioned calculation, creates the acceleration/ deceleration pulse output table using the parameters below. It determines whether the calculated values are subject to "warning."

Output frequency (Hz)	500
Output pulse count (pulse)	300
Initial frequency (Hz)	10
Acceleration/Deceleration time (milliseconds)	600

The frequency, pulse shot and acceleration/deceleration time for each phase are as follows.

n phase	Frequency	Pulse shot	Acceleration/ Deceleration time
1	10	1	100
2	59	3	50
3	108	6	55
4	157	9	57
5	206	12	58
6	255	15	58
7	304	18	59
8	353	21	59
9	402	24	59
10	451	27	59

Output pulse count total

The total of Output pulse counts for all phases is $(1+3+6+ \dots +27) \times 2+1=273$. Since the value is smaller than the Output pulse count you set, it clears the "acceleration/deceleration is excessive" warning.

Acceleration/Deceleration time total

The total acceleration/deceleration time necessary for all phases is $100+50+55+ \dots +59=614$. Since the value is larger than the acceleration/deceleration time you set, the "acceleration/ deceleration time is insufficient" warning appears.

■ Acceleration/Deceleration Pulse Output Terminal Status

This function shows the pulse output state in the output terminal.

#L_ExIOSpOut

H	0	0	0	0	0	0	0	0	0	0	0	0	0	0	0	0																
L	CH4 information				CH3 information				CH2 information				CH1 information																			
	15				12				8				4				0															
	Unused				d				Unused				c				Unused				b				Unused				a			

- a: CH1 output state 1: Output, 0: Not output
- b: CH2 output state 1: Output, 0: Not output
- c: CH3 output state 1: Output, 0: Not output
- d: CH4 output state 1: Output, 0: Not output

30.5.12 Pulse Catch

Pulse catch is a feature that imports pulse signals that are shorter than the logic scan time. You can import pulses longer than 10 microseconds (ON for more than 5 microseconds). You can use up to 4 channels for setting the pulse catch and each channel can have respective settings.

■ Summary

The procedure for setting the pulse catch is summarized below.

1. Set the input edge.
2. See "Special I/O state" for acknowledgment.

NOTE

- Some of the settings can be configured in the logic program's I/O driver instructions.

☞ "31.24 I/O Driver Instructions" (page 31-575)

■ Input Edge

For the input edge, you can select either the up or down settings to detect the pulse you import.

◆ Setting Method

- 1 Select [I/O Driver] in [System Settings].
- 2 For each CH on the [Internal Driver 1] screen, select Pulse Catch and click the "Pulse Catch Settings" button that appears in the terminal attributes.

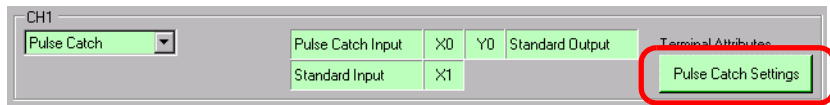

- 3 The [Pulse Catch Settings] dialog box appears. Select [Up] or [Down].

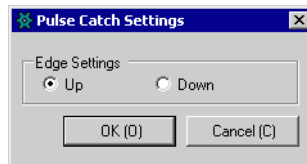

■ Pulse Catch Input Status

Use pulse catch to import pulse without setting the start and stop flags.

The pulse catch detect flag shows the pulse catch detection state under the CH special I/O state in the system variable (#L_ExIOSpCtrl). The watch bit will differ, depending on the CH to which you allocate the pulse catch.

#L_ExIOSpCtrl

H	CH4 Special I/O state	CH3 Special I/O state	CH2 Special I/O state	CH1 Special I/O state
L	CH4 Special I/O control	CH3 Special I/O control	CH2 Special I/O control	CH1 Special I/O control

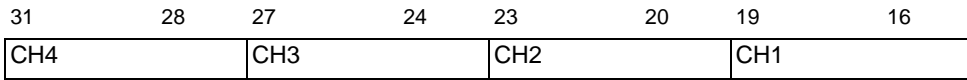

If the 1st bit in the CH is 1, the pulse input has been detected. If it is 0, the input has not been detected.

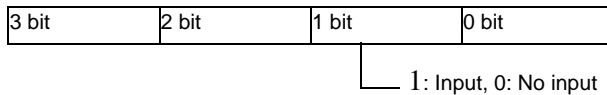

■ Pulse Catch Clear

Use this function to clear the pulse catch. The pulse catch clear turns OFF the pulse catch detect flag using the pulse catch clear flag under the CH special I/O control in the system variable (#L_ExIOSpCtrl).

To detect the sequential pulses, turn OFF the pulse catch detect flag, acknowledge the status with the clear completion flag under the special I/O state, and perform the pulse detect below. The Operation bit will differ, depending on the CH to which you allocate the pulse catch.

◆ **Setting Method**

1 Regarding the details in [Control Special I/O], the Operation bit will differ, depending on the CH to which you allocate the pulse catch, as shown below.

#L_ExIOSpCtrl

H	CH4 Special I/O state	CH3 Special I/O state	CH2 Special I/O state	CH1 Special I/O state
L	CH4 Special I/O control	CH3 Special I/O control	CH2 Special I/O control	CH1 Special I/O control

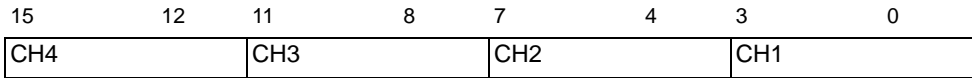

Turn ON the start bit of the CH to clear the pulse catch.

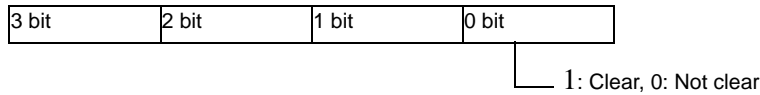

2 In [Special I/O State], check whether Clear is complete. Details of variables differ depending on the CH to which you allocate the pulse catch, as in the following figure.

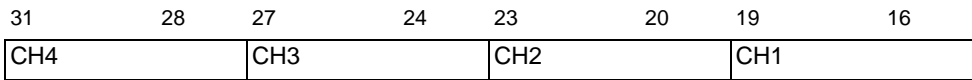

If the start bit of the CH (0 bit) is 1, the pulse catch has been cleared.

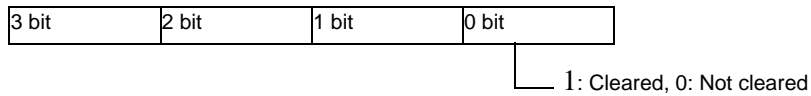

30.5.13 Error information

The system variable #L_IOStatus stores error information in the bottom 8 bits.

#L_IOStatus

H	0								
L	Major Fault	0	0	0	0	0	0	0	Error Code

Major Fault

The value is set to "1" upon detection of any error requiring the logic to stop.

■ Error code

	Error Code	Error Messages	Description		Solution
Project data related error	001	Module type error	The module setting type is not supported	Logic stop error	The project file might not have been sent properly. Transfer the project file again.
	002	Setting value error	The variable mapped to the terminal is incorrect. Invalid terminal settings		
	003	Device out-of-range error	The variable address allocated to the terminal is not correct.		
	004	Excess terminal settings	The number of terminals is not correct. (Too many terminals)		
	005	Terminal setting order error	The terminal no. is not in ascending order.		
	006	Terminal registry short	The number of terminals is not correct. (Too few terminals)		
	007	Module settings duplicated	The module is registered twice.		
	008	Excess module settings	The number of modules is not correct. (Too many modules)		
	009	Driver settings duplicated	The driver is registered twice.		
	010	I/O settings inconsistent	The terminal settings are not correct (Module I/O settings are not consistent).		
	011	Bit/Integer type inconsistent	The terminal settings are not correct (Module variable type settings are not consistent).		
	012	Setting level value error	The driver is not correct.		
	013	Data obtaining address error	The driver information is in correct. The controller information is not correct.		
	014	Driver ID error	The driver/Module registry results in an error and have not been registered.		
	015	Module setting order error	The module no. is not in ascending order.		
	016	File Version Error	Not compatible with the driver's file version		

Continued

	Error Code	Error Messages	Description		Solution
H/W related error	050	I/O board ID different	The connected I/O board is not correct.	Logic stop error	<p>The display type might not be correct. Check the display type and transfer the project file again.</p> <p>The project file might not have been sent properly. Transfer the project file again. If the problem is still not solved, there may be a problem with the hardware. Contact your support center.</p>
	051	Unsupported model error	The driver does not support the model.		
	052	IO initial error	The I/O board initialization fails.		
	053	IO ROM error	There is a problem with the system ROM on the I/O board.		
	054	IO RAM error	There is a problem with the system RAM on the I/O board.		
	055	IO microcomputer error	There is a problem with the microcomputer on the I/O board.		
	056	IO IF RAM error	There is a problem with the system I/F RAM on the I/O board.		
	057	IO E2PROM error	There is a problem with the system E2PROM on the I/O board.		
Application related error	100	I/O board error	The I/O board does not respond.	I/O update continuing error	<p>The parameter is not correct. Reset the parameter and request the parameter change.</p> <p>The parameter is not correct. Reset the parameter and request the acceleration/ deceleration table creation.</p> <p>The parameter is not correct. It will be returned to the initial value set with the editor. Reset the parameter and request the parameter change.</p>
	101	Special IO parameter error	There is a problem with the special I/O parameter you set.		
	102	Acceleration/ Deceleration table creation error	There is a problem with the special I/O parameter you set.		
	103	Initial parameter error	There is a problem with the special I/O parameter during initial processing.		

Continued

	Error Code	Error Messages	Description		Solution
Internal error	200	Integer type data read error	Reading the integer type terminal data value failed.	I/O update continuing error	The project file might not have been sent properly. Transfer the project file again.
	201	Bit type data read error	Reading the bit type terminal data value failed.		
	202	Integer type data write error	Writing the integer type terminal data value failed.		
	203	Bit type data write error	Writing the bit type terminal data value failed.		

30.5.14 Restrictions

■ Input Filter Function Restrictions

The input filter function has a restriction on the width of input pulses.

- X0, X2, X4, X6 Terminals

There is an input delay time of 5 microseconds for ON→OFF and 5 microseconds for OFF→ON when running sampling every 0.5 milliseconds

5 microseconds (ON→OFF) + 0.5 milliseconds (Sampling Interval) + 5 microseconds (OFF→ON) = 0.51 milliseconds

As a result, 0.51 milliseconds is the limit for the smallest input pulse width

- X1, X3, X5, X7, X8, X9, X10, X11 Terminals

There is an input delay time of 0.5 milliseconds for ON→OFF and 0.5 milliseconds for OFF→ON when sampling every 0.5 milliseconds

0.5 milliseconds (ON→OFF) + 0.5 milliseconds (sampling interval) + 0.5 milliseconds (OFF→ON) = 1.5 milliseconds

As a result, 1.5 milliseconds is the limit for the smallest input pulse width

■ Pulse Output Usage Restrictions

For pulse outputs, when combining the number of CH and high-speed counters used, there is a limit to the maximum output frequency.

While the pulse output maximum frequency is 65000 Hz, when combined with how many CH and high-speed counters are used as illustrated in the following table, there is a limit to the output frequency setting.

For example, when using 3 pulse output CH and 1 high-speed counter CH, the maximum output frequency per CH is 27027 Hz.

Pulse Output 1CH Maximum Frequency

		Pulse output			
		1 CH	2 CH	3 CH	4 CH
High Speed Counter (1 phase, 2 phase)	Do Not Use	65000 Hz	45454 Hz	30303 Hz	22727 Hz
	1 CH	65000 Hz	38461 Hz	27027 Hz	--
	2 CH	52631 Hz	33333 Hz	--	--
	3 CH	43478 Hz	--	--	--
	4 CH	--	--	--	--

* "--" indicates cannot use.

* 2 phase counter has a maximum 2 CH. In the table, 3 CH is for single phase counters.

Verification of these limits occur when the LT starts up and when parameters change.

When an error arises, error information is stored in the system variable

(#L_ExIOSpParmErr). For more details, see " ■ Abnormal Status of Normal Pulse Output" (page 30-103).

