

# 32 | Simulation

This chapter provides an overview of the "Simulation" feature of GP-Pro EX and the basic operation for the simulation.

Begin reading "32.1 Settings Menu" (page 32-2) and proceed to the description in the desired section.

32.1	Settings Menu .....	32-2
32.2	Checking the Display operation on the PC. ....	32-3
32.3	Checking the operation of the I/O driver on the PC .....	32-7
32.4	Checking the Logic Operation on the PC.....	32-12
32.5	Settings Guide.....	32-17
32.6	Restrictions .....	32-27

## 32.1 Settings Menu

Checking the Display operation on the PC.	
	<ul style="list-style-type: none"> <li>☞ Setup Procedure (page 32-4)</li> <li>☞ Introduction (page 32-3)</li> </ul>

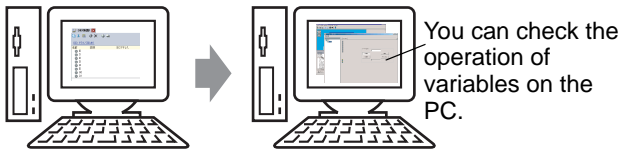
Checking the operation of the I/O driver on the PC	
	<ul style="list-style-type: none"> <li>☞ Setup Procedure (page 32-8)</li> <li>☞ Introduction (page 32-7)</li> </ul>

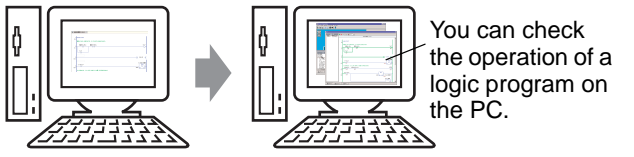
Checking the Logic Operation on the PC.	
	<ul style="list-style-type: none"> <li>☞ Setup Procedure (page 32-13)</li> <li>☞ Introduction (page 32-12)</li> </ul>

## 32.2 Checking the Display operation on the PC.

### 32.2.1 Introduction

Using the simulation feature, you can verify how the project operates before transferring it to the device/PLC. You do not have to save the project before simulating, making it ideal for debugging as you edit and create the project. You can even keep simulation running while you open and edit a different project in GP-Pro EX.

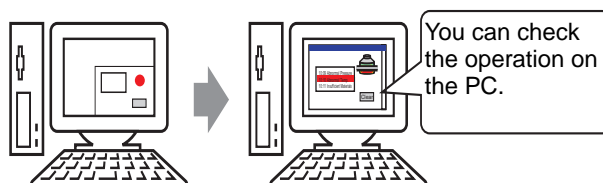

## 32.2.2 Setup Procedure

**NOTE**

- Please refer to the Settings Guide for details.
    - ☞ "32.5.1 Setting Guide for [GP-Pro EX Simulation]" (page 32-17)
    - ☞ "32.5.2 [Address View] Setting Guide" (page 32-21)
- 

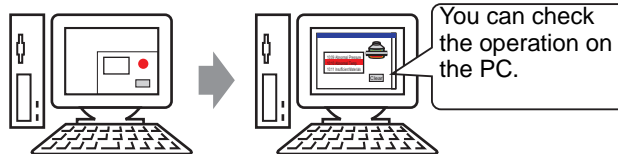

- 1 Open the project file you want to simulate. From the [Project (F)] menu, select [Simulation (L)].

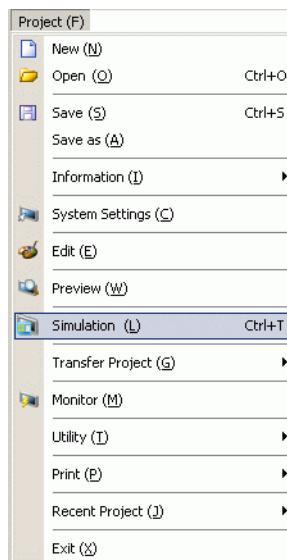

**NOTE**

- You can also use the keyboard shortcut Ctrl+T to start simulation.
  - You can also click  from the State bar to start simulation.
-

2 [GP-Pro EX Simulation] is displayed.

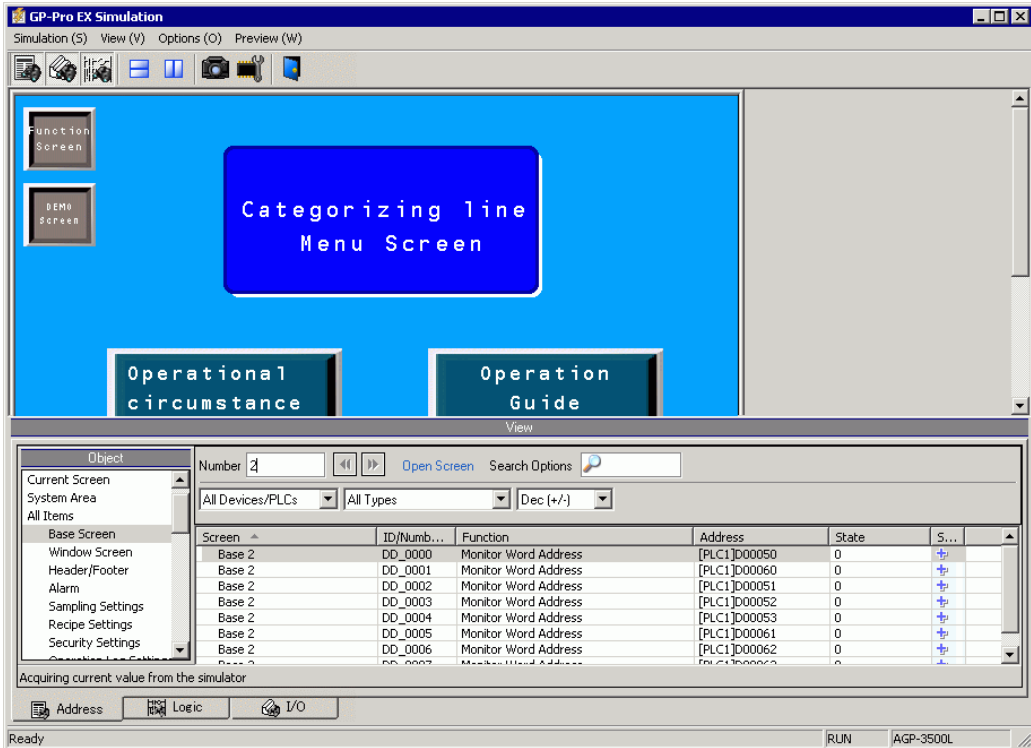

3 You can check the operation of the project file in progress through [GP-Pro EX Simulation] located at the top of the screen.

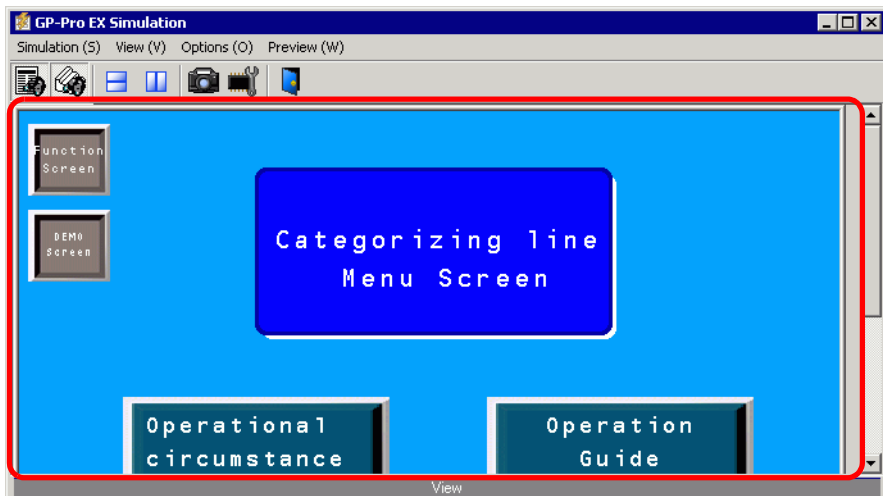

**NOTE**

- If you simulate a different project file or the current project file after you make edits, select [Simulation (L)] from the [Project (F)] menu again.

4 [Address View] allows you to display a list and edit the current value of the virtual device/ PLC address used for simulation. Select the item you want to view from the [Object] pane (Base Screen)

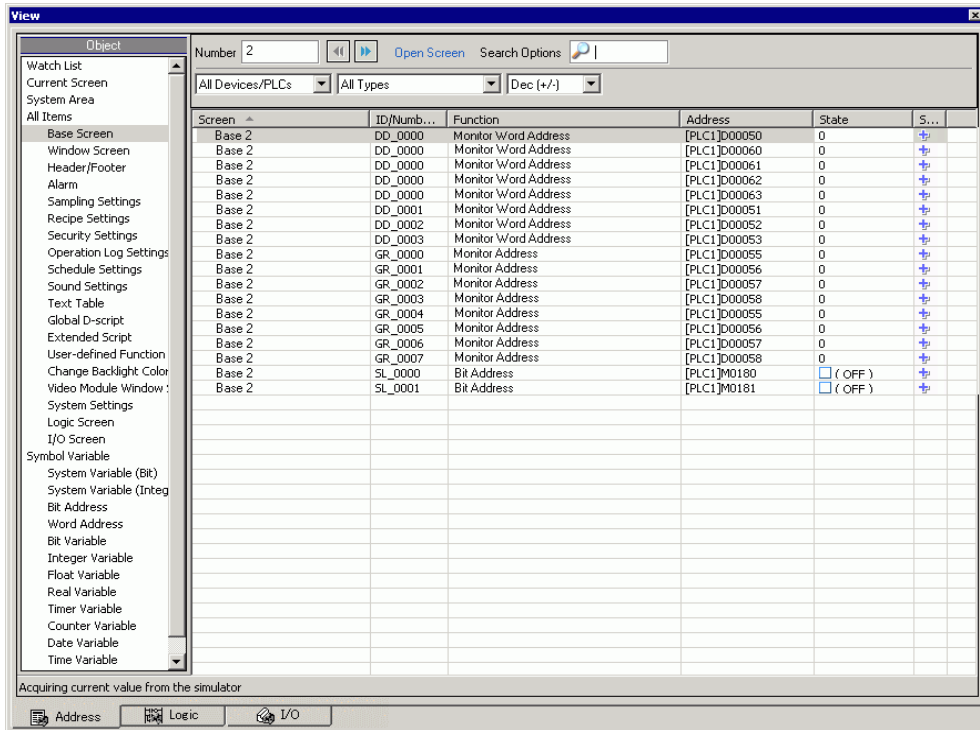

**NOTE**

- If [Address View] does not display, select [Preview (W)] and then [Address (D)] from the [View (V)] menu, or click .
- If [I/O View] or [Logic View] is displayed over the [Address View], click the [Address] tab to bring [Address View] to the front.

5 In the [Address View], set the screen number from [Number] to switch the address display screen.

(For example, 10)

6 To toggle the bit address ON or OFF, click  in the [State] field. To change the value in a word address in [Address View], select the value in the [State] field and make the change.

7 Select [Exit from Simulation (X)] from the [Simulation (S)] menu or click to exit the simulation feature. [GP-Pro EX Simulation] and [Address View] will be closed.

**NOTE**

- The backup file data for SRAM is deleted after the simulation ends. To save the backup file, select [Configure Memory (M)] from the [Option (O)] menu or click . If you select the [Backup the PLC device] check box from the [Configure Device Memory] dialog box, the data of the same address can be read when the same file is opened again.

## 32.3 Checking the operation of the I/O driver on the PC

### 32.3.1 Introduction

Before transferring the project file, you can confirm the current address value by simulating the address allocated to the I/O Terminal of the I/O Driver to control external I/O. Some I/O Drivers allow you to switch Input ON/OFF and update the current value when you enter a value.

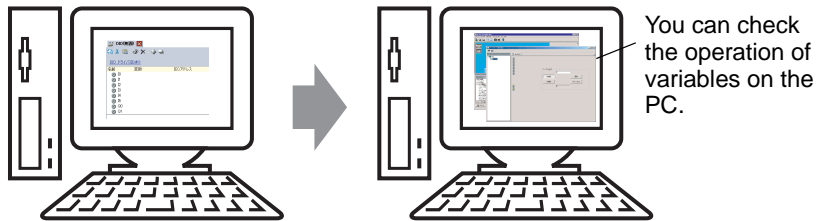

### 32.3.2 Setup Procedure

**NOTE**

- Please refer to the Settings Guide for details.
  - ☞ "32.5.1 Setting Guide for [GP-Pro EX Simulation]" (page 32-17)
  - ☞ "32.5.3 [I/O View] Settings Guide" (page 32-24)

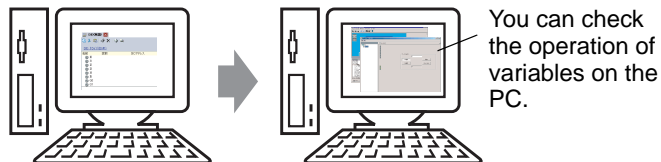

1 Open the project file you want to simulate. From the [Project (F)] menu, select [Simulation (L)].

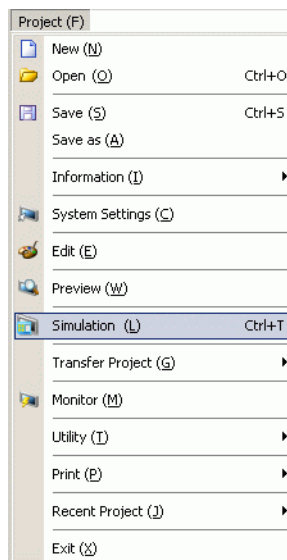

**NOTE**

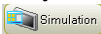
- You can also use the keyboard shortcut Ctrl+T to start simulation.
- You can also click  from the State bar to start simulation.



2 [GP-Pro EX Simulation] is displayed.

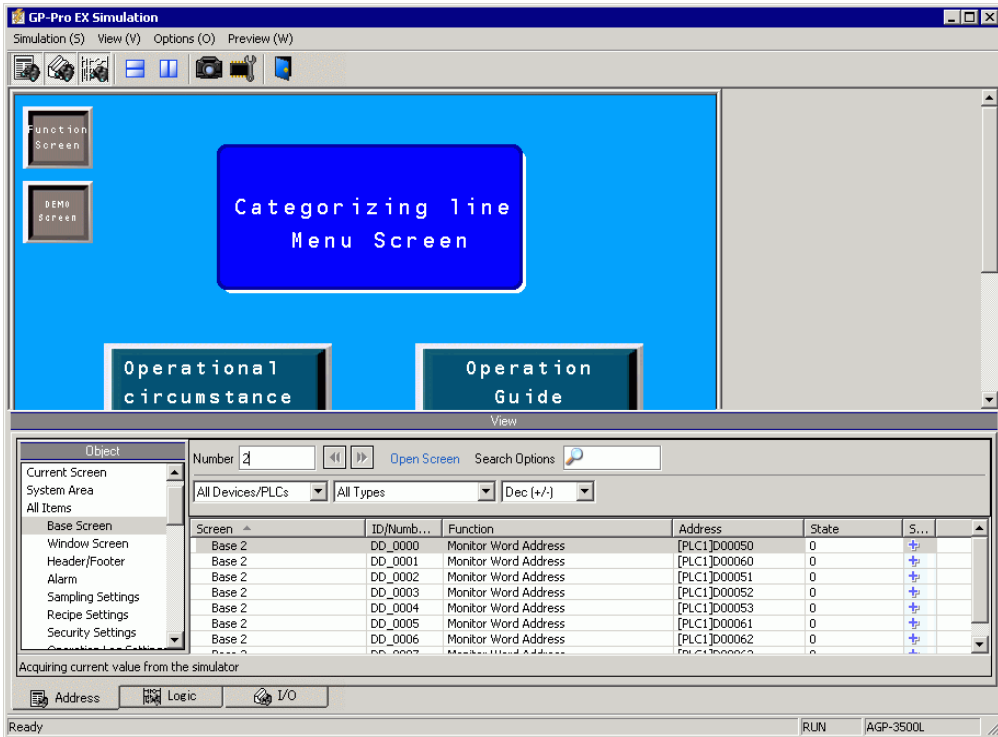

**NOTE** • If you simulate a different project file or the current project file after you make edits, select [Simulation (L)] from the [Project (F)] menu again.

3 Select [Preview (W)] and point to [I/O(I)] from the [View (V)] menu, or click . [I/O View] appears.

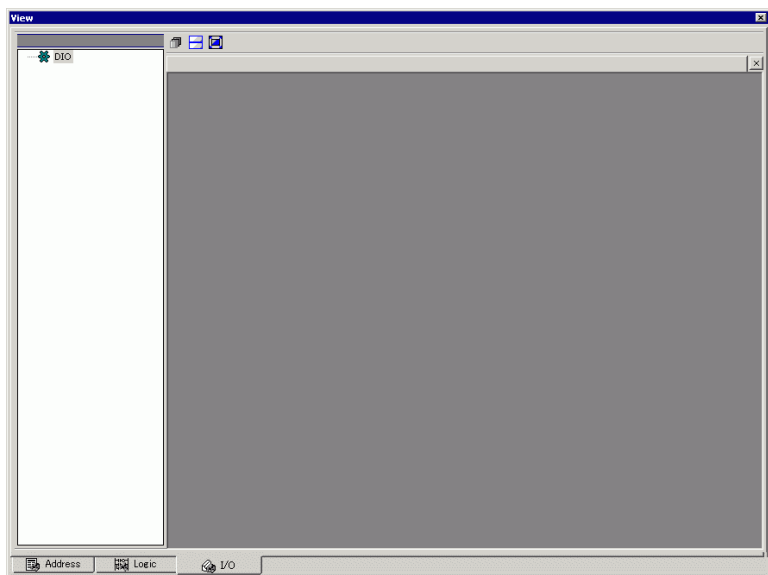

**NOTE** • If [Address View] or [Logic View] is displayed over the [I/O View], click the [I/O] tab to bring the [I/O View] to the front.

- 4 In [I/O View], you can view or change the current value of the address allocated to the I/O Terminal of the I/O Driver. Select the I/O Driver to display from [I/O Driver List]. The Basic screen of the I/O Driver displays.  
(For example: DIO Driver)

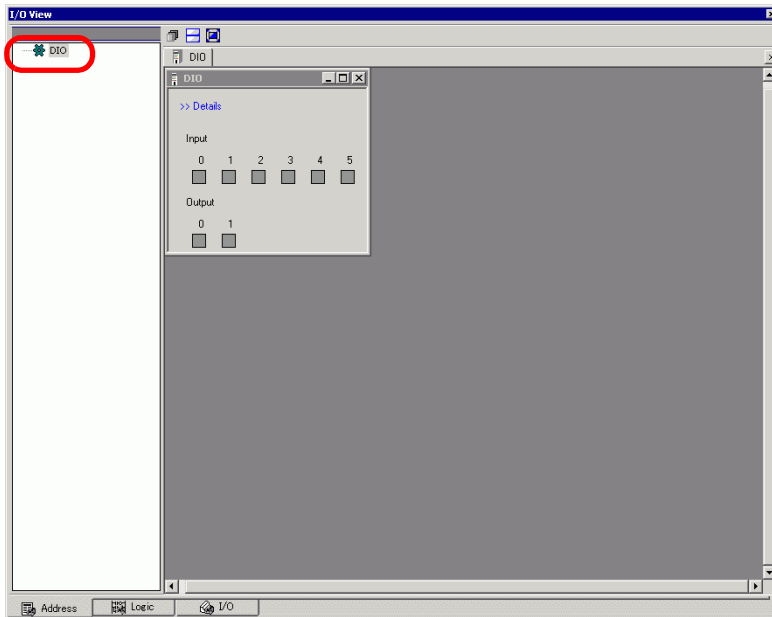

- 5  Click to extend the window of the Driver display area over the entire screen.

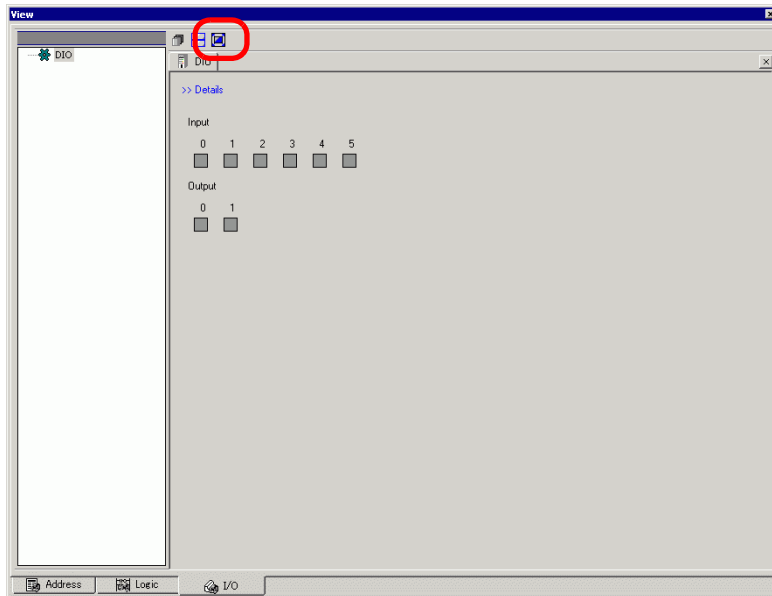

- 6  By pointing the cursor to the icon, the name of the variable displays.

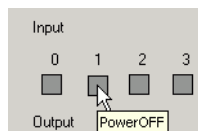

7 By clicking [Details], the detail screen of the I/O Driver displays.

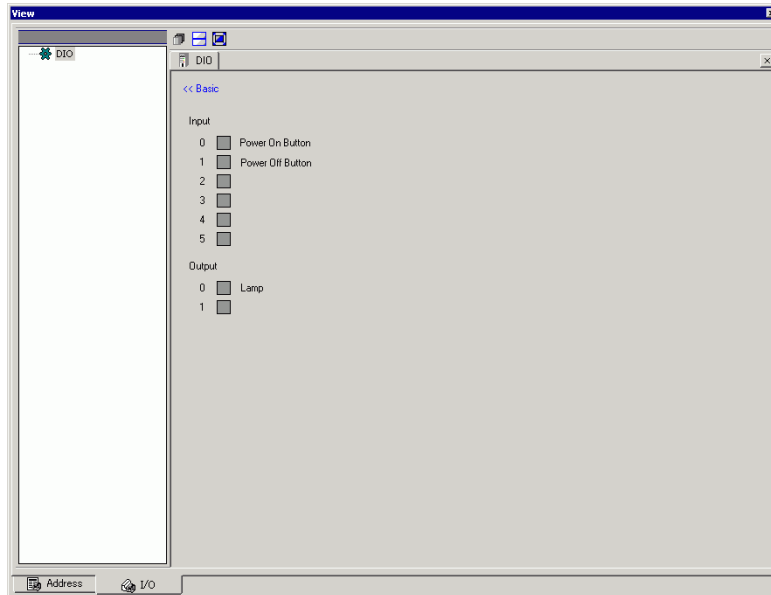

8 Click  when you want to switch ON/OFF the bit address. This changes the ON/OFF state by clicking.

9 To enter a new value for the current Integer type address, enter the value and then press the [ENTER] key.

This updates the current value.

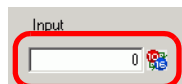

10 Select [Exit from Simulation (X)] from the [Simulation (S)] menu of [GP-Pro EX Simulation] or click  to exit the simulation feature. [GP-Pro EX Simulation], [Address View], and [I/O View] will close.

**NOTE**

- The backup file data for SRAM is deleted after the simulation ends. To save the backup file, select [Configure Memory (M)] from the [Option (O)] menu or click . If you select the [Backup the PLC device] check box in the [Device Memory Settings] dialog box, the data of the same address can be read when the same file is re-opened.

## 32.4 Checking the Logic Operation on the PC.

### 32.4.1 Introduction

You can check the operation of the logic program before you transfer the project file and without connecting to the GP.

You can check the symbol variable ON/OFF state or current values. This is useful for debugging the logic program.

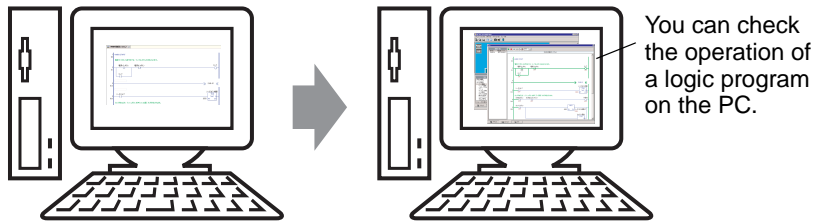

## 32.4.2 Setup Procedure

**NOTE**

- Please refer to the Settings Guide for details.
  - ☞ "32.5.1 Setting Guide for [GP-Pro EX Simulation]" (page 32-17)
  - ☞ "32.5.4 [Logic View] Settings Guide" (page 32-26)



- 1 Open the project file you want to simulate. From the [Project (F)] menu, select [Simulation (L)].

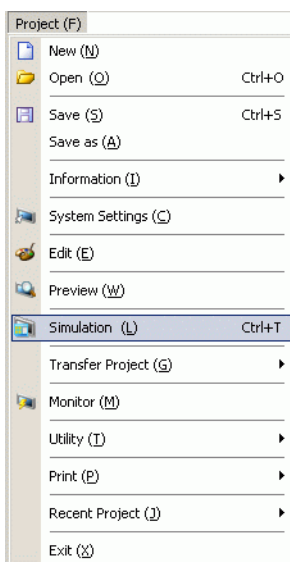

**NOTE**

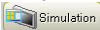
- You can also use the keyboard shortcut Ctrl+T to start simulation.
- You can also click  from the State bar to start simulation.

2 [GP-Pro EX Simulation] is displayed.

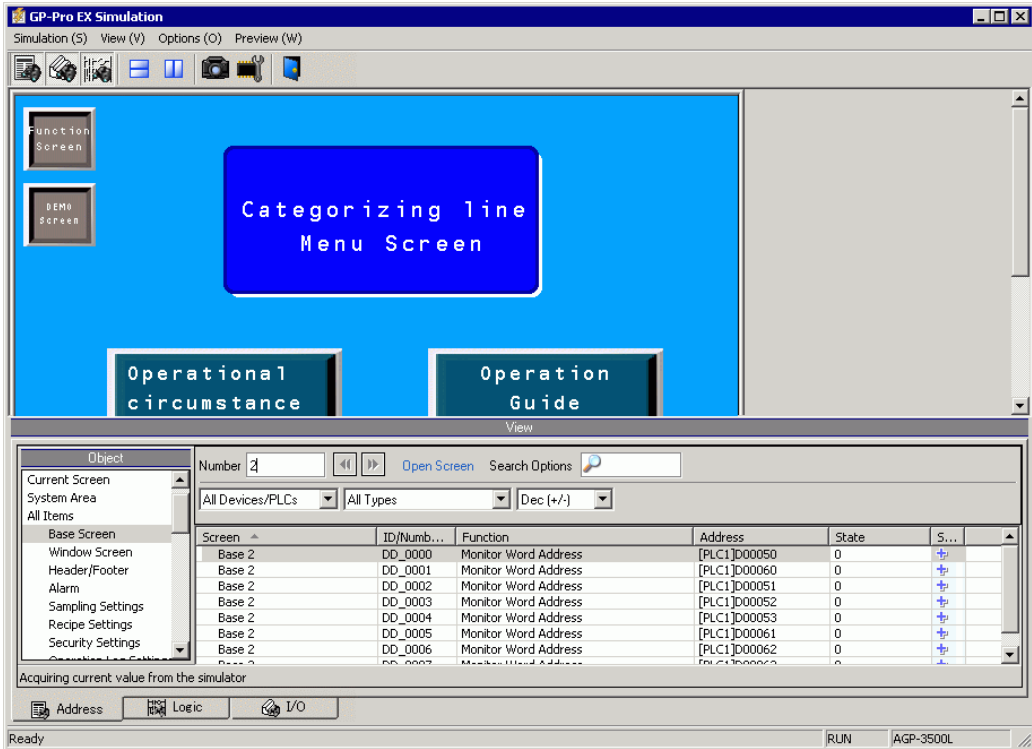

**NOTE**

- If you simulate a different project file or the current project file after you make edits, select [Simulation (L)] from the [Project (F)] menu again.

- 3 Select [Preview (W)] and point to [Logic (L)] from the [View (V)] menu, or click . [Logic View] is displayed.

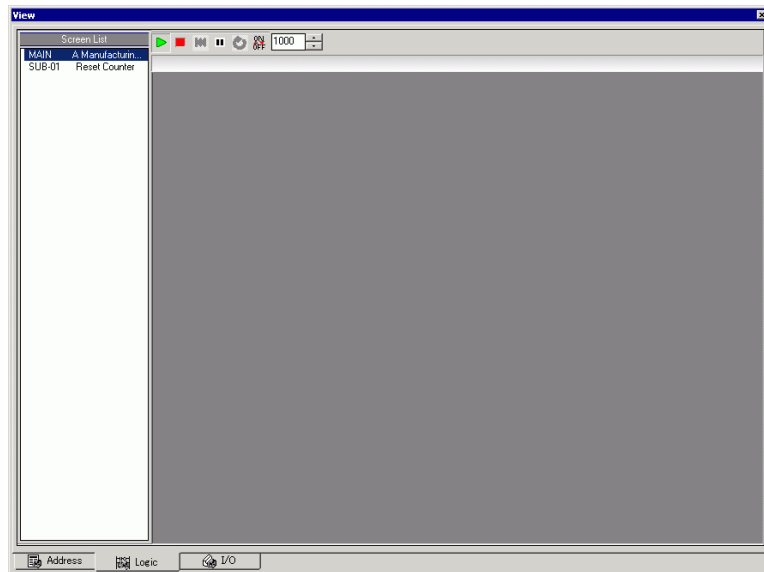

**NOTE**

- If [Address View] or [I/O View] is displayed on the front, click the [Logic] tab to bring the [Logic View] to the front.

- 4 From [Screen List], double-click the logic program you want to display. In the [Logic View], operational status of the logic program is shown with green lines. (For example, MAIN A Manufacturing System)

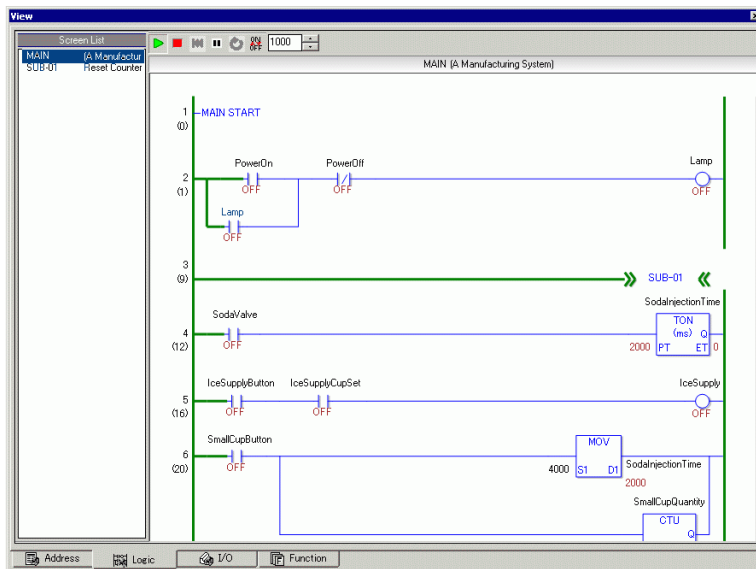

- 5 In order to switch the symbol variables ON/OFF, right-click to select [ON]/[OFF] or [Force ON]/[Force OFF].

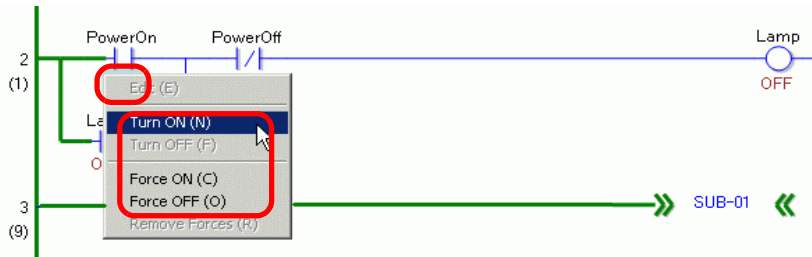

**NOTE**

- When you specify [Force ON] or [Force OFF], the symbol variable keeps its ON or OFF state until you remove forces.

- 6 In order to change the current value of the symbol variables, right-click the value and select [Edit] or double-click on the value to change it. This updates the current value.

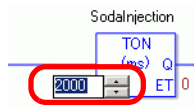

- 7 To stop the logic program, click (Stop) or select (Pause).

- 8 Select [Exit from Simulation (X)] from the [Simulation (S)] menu of [GP-Pro EX Simulation] or click to exit the simulation feature. [GP-Pro EX Simulation], [Address View], [I/O View], and [Logic View] will close.

**NOTE**

- The backup file data for SRAM is deleted after the simulation ends. To save the backup file, select [Configure Memory (M)] from the [Option (O)] menu or click . If you select the [Backup the PLC device] check box in the [Device Memory Settings] dialog box, the data of the same address can be read when the same file is re-opened.







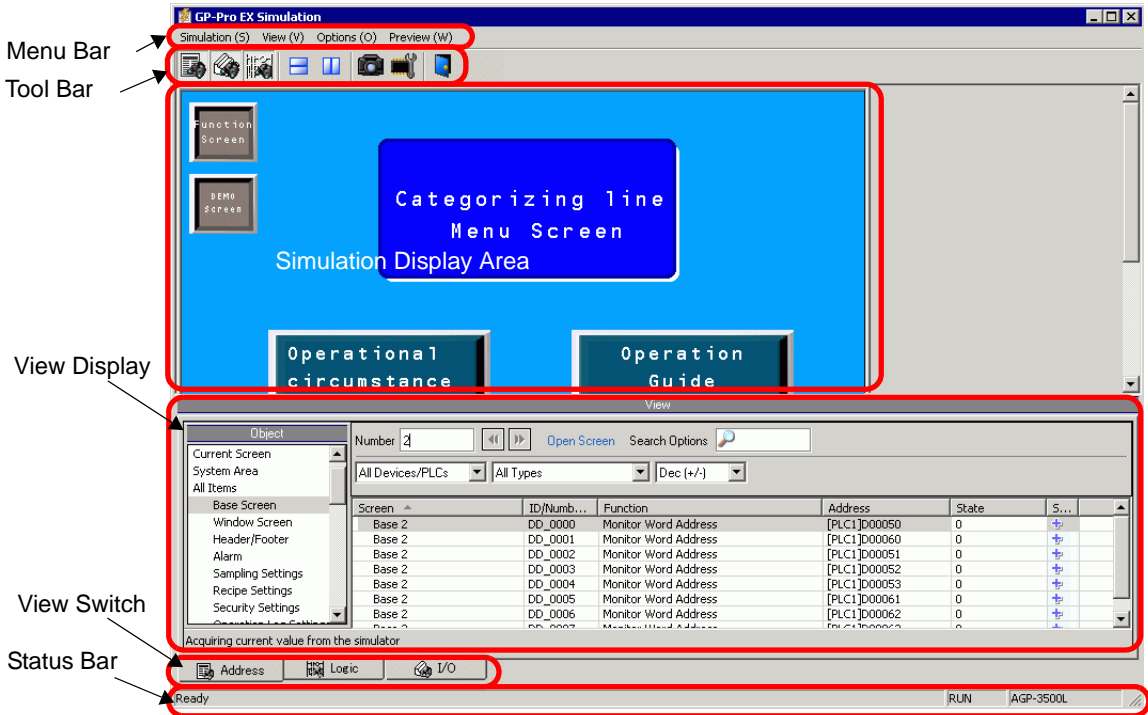

## 32.5 Settings Guide

### 32.5.1 Setting Guide for [GP-Pro EX Simulation]











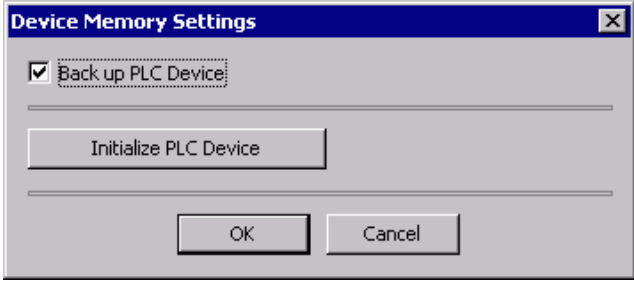

Setting	Description
Menu Bar	The menu to simulate displays. When you point to a menu item, a pull-down menu appears.

Continued

Setting	Description
Simulation	<ul style="list-style-type: none"> <li>• In [Simulation screen], select [Utility] and point to [Save Screen] Or click  to saves the screen image in a JPEG file format.</li> </ul> <p><b>NOTE</b></p> <ul style="list-style-type: none"> <li>• You can specify the quality of the screen capture screen to save in the [Screen/Video Capture Settings]'s [Capture Image Quality] field.</li> </ul> <p>Save in C:\Program Files\Pro-face\GP-Pro EX ***\CFA00\&gt;CAPTURE (***) stores the version number)</p> <p>File Name "CAP + year, month, day, hours, minutes, seconds, and automatically generated three digit number + .jpg". You cannot change how this file-name is generated.</p> <ul style="list-style-type: none"> <li>• [Simulation Exit] Exit simulation.</li> </ul> <p><b>NOTE</b></p> <ul style="list-style-type: none"> <li>• You can exit the simulation by using any of the following methods: <ul style="list-style-type: none"> <li>•Click  in [GP-Pro EX Simulation]</li> <li>•Click  on the tool bar</li> <li>•Right-click the simulation display area. Select [Close] from the menu.</li> </ul> </li> </ul>
Display	<ul style="list-style-type: none"> <li>• [Toolbar] Switch the show/hide for the Toolbar.</li> <li>• [Status Bar] Switch the show/hide for the Status.</li> <li>• Select [View] and point to [Address]/[I/O] <ul style="list-style-type: none"> <li>•Address View Switch the show/hide for the Address View. This displays or hides the current value of the virtual device/PLC address for the simulation function. Click  to display/hide. For more information on [Address View], see the following.  "32.5.2 [Address View] Setting Guide" (page 32-21)</li> <li>•I/O View Switch the show/hide for the I/O View. This displays or hides the current value of the virtual device/PLC address set in the I/O View screen. Click  to display/hide. For more information on [I/O View], see the following.  "32.5.2 [Address View] Setting Guide" (page 32-21)</li> </ul> </li> </ul>

Continued

Setting	Description
Option	<ul style="list-style-type: none"> <li>• Memory settings When you select this, the [Device Memory Settings] dialog appear as follows. You can backup or initialize the data of the virtual device/PLC address.  to open the dialog box.</li> </ul>  <ul style="list-style-type: none"> <li>•Back up PLC Device When you exit the simulation, specify whether to back up the virtual device/PLC address. By backing up, you can retrieve the data from the same address when you open the same file.</li> <li>•Initialize PLC Device Select [Initialize PLC Device] to clear all of the virtual device/PLC address data to 0.</li> </ul>
View	<ul style="list-style-type: none"> <li>• [Tile Horizontally] When you display multiple views, windows appear tiled from top to bottom. You can click  to do the same operation.</li> <li>• [Tile Vertically] When you display multiple views, the views can be laid out into a right and left half. You can click  to do the same operation.</li> </ul>
Tool Bar	<ul style="list-style-type: none"> <li>•  Select the show/hide of Address View.</li> <li>•  Select display/hide for I/O View.</li> <li>•  Select display/hide for Logic View.</li> <li>•  Divide views horizontally.</li> <li>•  Divide views vertically.</li> <li>•  Produce a hard copy of an HMI screen.</li> <li>•  Configure Device Memory.</li> <li>•  Exit simulation.</li> </ul>
Simulation Display Area	Displays the simulation results for the project file on the Edit screen, where you can check the operation of the file.
View Display Area	This is the area for displaying [Address View], [I/O View] and [Logic View]. [Address View], [I/O View] and [Logic View] can be separated from [GP-Pro EX Simulation] when you drag and drop.
View Switch Tab	Tabs of the Views on the screen display. Click a tab to change the view.
Status Bar	Displays the model of display unit.

## ■ Right-click menu

The following menu appears when you right-click the simulation view screen.

Change Panel

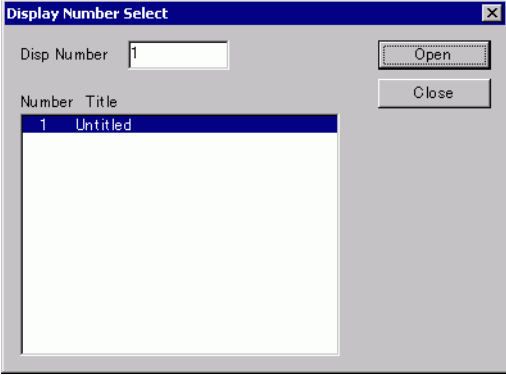
Setting	Description
Screen Change	<p>The [Display Number Select] dialog box appears. You can switch the display screen.</p> 
Screen Number	Specify the base screen number that you want to switch to in the range of 1 to 9999. Only screens in the project can be opened in the Simulation.
List	Displays the screen number and title.
Open	Open the selected screen.
Close	Close the dialog box.

### 32.5.2 [Address View] Setting Guide

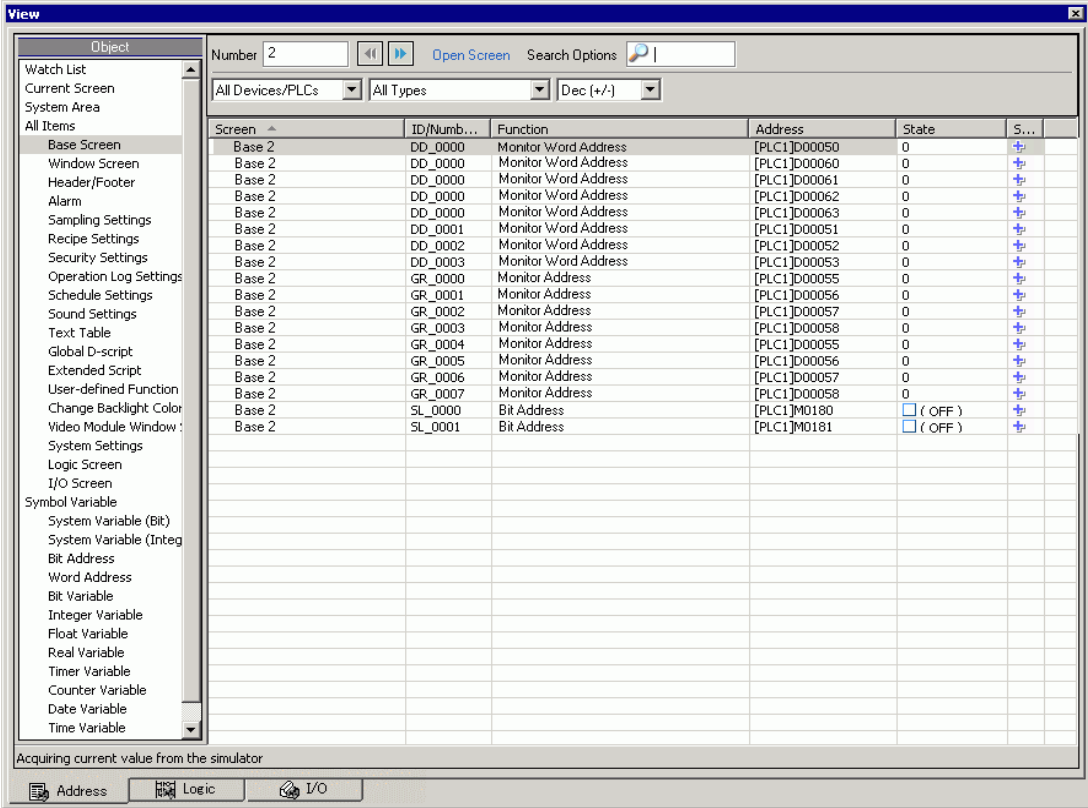

Setting	Description
Object	<p>Select the object items of the address you want to display in [Address View].</p> <p><b>NOTE</b></p> <ul style="list-style-type: none"> <li>If the objects are other than [Symbol Variable], the variables which are not used do not display in [Address View] of simulation even though you have registered variables. When the objects are [Symbol Variable], all variables display regardless of whether they are used or not.</li> </ul>
Number	<p>Define the screen number you want to view with 5 digits or less.</p> <p><b>NOTE</b></p> <ul style="list-style-type: none"> <li>You can only specify this when selecting [Base Screen], [Window Screen], or [Video Module Window] as the [Object].</li> <li>If you set up a [Screen Number] that cannot be saved, the number will appear in red.</li> </ul>
	The address information of the connected device for the screen before or after the screen input in [Screen Number].
Open Screen	Displays the screen that contains the [Screen Number] on [Simulation View].

Continued

Setting	Description																												
Search Options	If you search for a string in [Screen], [ID/No./Rung], [Function], and [Address], all address information that includes the string is displayed.																												
Device/PLC	Select the device/PLC in the project file that you want to view: [All Devices/PLCs], [PLC1], [#INTERNAL], or [Symbol Variable].																												
Type	Select the address type to display. When you select [All Types], all types of addresses display.																												
Format	<p>For the display [State] and data input formats, select [Oct], [Dec], [Dec (+/-)], [Hex], [BCD] or [Float]. The format of all the display data changes.</p> <table border="1" data-bbox="395 498 1236 1035"> <thead> <tr> <th data-bbox="395 498 532 537">Bit Length</th> <th data-bbox="532 498 738 537">Format</th> <th data-bbox="738 498 1236 537">Input/Display Range</th> </tr> </thead> <tbody> <tr> <td data-bbox="395 537 532 807" rowspan="6">16 Bit</td> <td data-bbox="532 537 738 575">Dec</td> <td data-bbox="738 537 1236 575">0 to 65535</td> </tr> <tr> <td data-bbox="532 575 738 614">Dec(+/-)</td> <td data-bbox="738 575 1236 614">-32768 to 32767</td> </tr> <tr> <td data-bbox="532 614 738 691" rowspan="2">Hex</td> <td data-bbox="738 614 1236 653">0 to FFFF(h)</td> </tr> <tr> <td data-bbox="738 653 1236 691">0 to FFFF(h)</td> </tr> <tr> <td data-bbox="532 691 738 768" rowspan="2">Oct</td> <td data-bbox="738 691 1236 730">0 to 177777(o)</td> </tr> <tr> <td data-bbox="738 730 1236 768">0 to 177777(o)</td> </tr> <tr> <td data-bbox="532 768 738 807">BCD</td> <td data-bbox="738 768 1236 807">0 to 9999</td> </tr> <tr> <td data-bbox="395 807 532 1035" rowspan="6">32 Bit</td> <td data-bbox="532 807 738 846">Dec</td> <td data-bbox="738 807 1236 846">0 to 4294967295</td> </tr> <tr> <td data-bbox="532 846 738 884">Dec(+/-)</td> <td data-bbox="738 846 1236 884">-2147483648 to 2147483647</td> </tr> <tr> <td data-bbox="532 884 738 962" rowspan="2">Hex</td> <td data-bbox="738 884 1236 923">0 to FFFFFFFF(h)</td> </tr> <tr> <td data-bbox="738 923 1236 962">0 to FFFFFFFF(h)</td> </tr> <tr> <td data-bbox="532 962 738 1000">BCD</td> <td data-bbox="738 962 1236 1000">0 to 99999999</td> </tr> <tr> <td data-bbox="532 1000 738 1035">Float</td> <td data-bbox="738 1000 1236 1035">±1.175494351e-38 to ±3.402823466e+38</td> </tr> </tbody> </table>	Bit Length	Format	Input/Display Range	16 Bit	Dec	0 to 65535	Dec(+/-)	-32768 to 32767	Hex	0 to FFFF(h)	0 to FFFF(h)	Oct	0 to 177777(o)	0 to 177777(o)	BCD	0 to 9999	32 Bit	Dec	0 to 4294967295	Dec(+/-)	-2147483648 to 2147483647	Hex	0 to FFFFFFFF(h)	0 to FFFFFFFF(h)	BCD	0 to 99999999	Float	±1.175494351e-38 to ±3.402823466e+38
	Bit Length	Format	Input/Display Range																										
16 Bit	Dec	0 to 65535																											
	Dec(+/-)	-32768 to 32767																											
	Hex	0 to FFFF(h)																											
		0 to FFFF(h)																											
	Oct	0 to 177777(o)																											
		0 to 177777(o)																											
BCD	0 to 9999																												
32 Bit	Dec	0 to 4294967295																											
	Dec(+/-)	-2147483648 to 2147483647																											
	Hex	0 to FFFFFFFF(h)																											
		0 to FFFFFFFF(h)																											
	BCD	0 to 99999999																											
	Float	±1.175494351e-38 to ±3.402823466e+38																											
Display Select Area	<p>The address information selected from [Object], [Number], [Device/PLC] and [Type] is displayed. You can select one line at the same time. Multiple lines cannot be selected at the same time.</p> <ul style="list-style-type: none"> <li>• <b>Screen</b> The active screen number and the settings are displayed.</li> <li>• <b>Location</b> The ID of components in use, the group of address, the block number and the line number are displayed.</li> <li>• <b>Feature</b> Displays which address is used by each function.</li> <li>• <b>Address</b> Displays the device/PLC name and address</li> <li>• <b>State</b> The current value changed to a [Type] string is displayed. If the current value cannot be displayed, [Retrieving] is displayed.</li> <li>• <b>Saves the watch list/Delete watch list</b> Saves or deletes the active device/PLC address.</li> </ul> <p><b>NOTE</b></p> <ul style="list-style-type: none"> <li>• When you select [Watch List] in [Object], you can [Delete].</li> </ul>																												

Continued

Setting	Description
Save watch list	<p>Saves the active device/PLC address in the watch list. When you save addresses in the watch list, you can confirm all addresses at one time.</p> <p><b>NOTE</b></p> <ul style="list-style-type: none"><li>• When you select [Watch List] in [Object], you can only [delete].</li><li>• The Watch List is common for all projects. Once an address is added to the watch list, that item is not removed unless specified. When a previously added address is not used in the current simulated project, then the address appears in red. Although you cannot display or edit red address values, you can remove them.</li></ul>
Current Value Editing	Change the current value. The assignable value range varies by the selected [Format].
Status Bar	<p>The following message shows the communication status of the simulation.</p> <p>Initialize: Starting communication with the simulator.</p> <p>Communication (Normally):Retrieving current value from the simulator.</p> <p>Communication Error:Unable to connect to the simulator.</p>



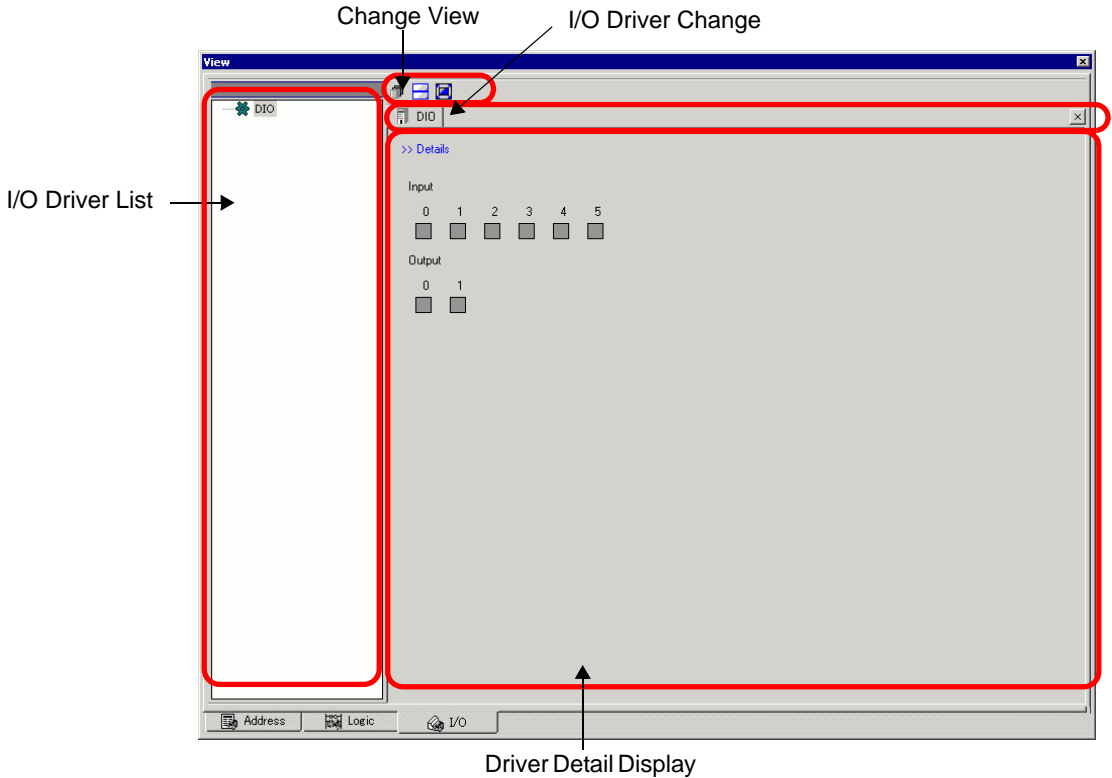







### 32.5.3 [I/O View] Settings Guide

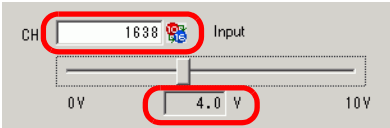

Setting	Description
I/O Driver List	Displays the list of the I/O Driver registered in the current edited project file. Select the I/O Driver to display in the Driver Detail Display Area.
Driver Detail Display Area	From the simulation, you can check the performance operation of the I/O Driver selected from the I/O Driver List. The Display Method differs depending on the selected I/O Driver.
Introduction	Change the Detail Screen/Basic Screen.
Current Value	<ul style="list-style-type: none"> <li>Bit Type  <input checked="" type="checkbox"/> Displays (ON)/<input type="checkbox"/> (OFF).</li> </ul> <p><b>NOTE</b></p> <ul style="list-style-type: none"> <li>When you click <input checked="" type="checkbox"/>, it switches ON/OFF for some I/O Drivers. You cannot perform output operations.</li> <li>DIO Driver, FLEX NETWORK Driver's DIO, LT Built-in DIO (STD) Driver's standard IO, EX module (EXM) Driver's DIO IO                      When the status is <input checked="" type="checkbox"/>, you can move the focus with the [TAB], [Up], [Down], [Left], and [Right] keys. Also, you can switch ON/OFF with the [SPACE] key.</li> <li>LT Built-in DIO Driver (STD)'s PWM Output/PLS Output, EXM Module (EXM) Driver's Analogue IO  <input checked="" type="checkbox"/> You can move the focus by [TAB].</li> </ul>

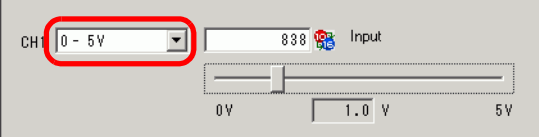
Continued



Setting	Description
<p>Current Value</p>	<ul style="list-style-type: none"> <li>• Integer Type Displays numeric values. When you start typing, the current value display stops. Enter numeric values and press the [ENTER] key. If you press a key other than the [ENTER] key or do other operations, anything you type is canceled.</li> <li>• Switch Decimal/Hexadecimal   <p> Decimal and hexadecimal systems are supported. Click  to display the numeric numbers in hexadecimal and click  to display them in decimal. You can switch the decimal/hexadecimal for every variable.</p> </li> <li>• Slider Bar When you select the FLEX NETWORK Driver, you can move the slider bar to display the current value in the edit box and the box below the slider bar depending on the position of the knob. Click the [ENTER] key to update the current value on the slider position.   </li> </ul> <p><b>NOTE</b></p> <ul style="list-style-type: none"> <li>•  You can move the focus by [TAB].</li> <li>• Range When you select the analog of the FLEX NETWORK Driver, select the Input/Output range.   </li> </ul>
<p>I/O Driver Change Tab</p>	<p>Displays tabs of displayed I/O drivers. Click a tab to switch to the individual I/O Driver settings.</p>
<p>Change View</p>	<ul style="list-style-type: none"> <li>•  Displays the windows in Driver Display Area in layers.</li> <li>•  Displays the windows in Driver Display Area in the upper and lower half.</li> <li>•  Maximizes the windows in Driver Display Area.</li> </ul>

### 32.5.4 [Logic View] Settings Guide

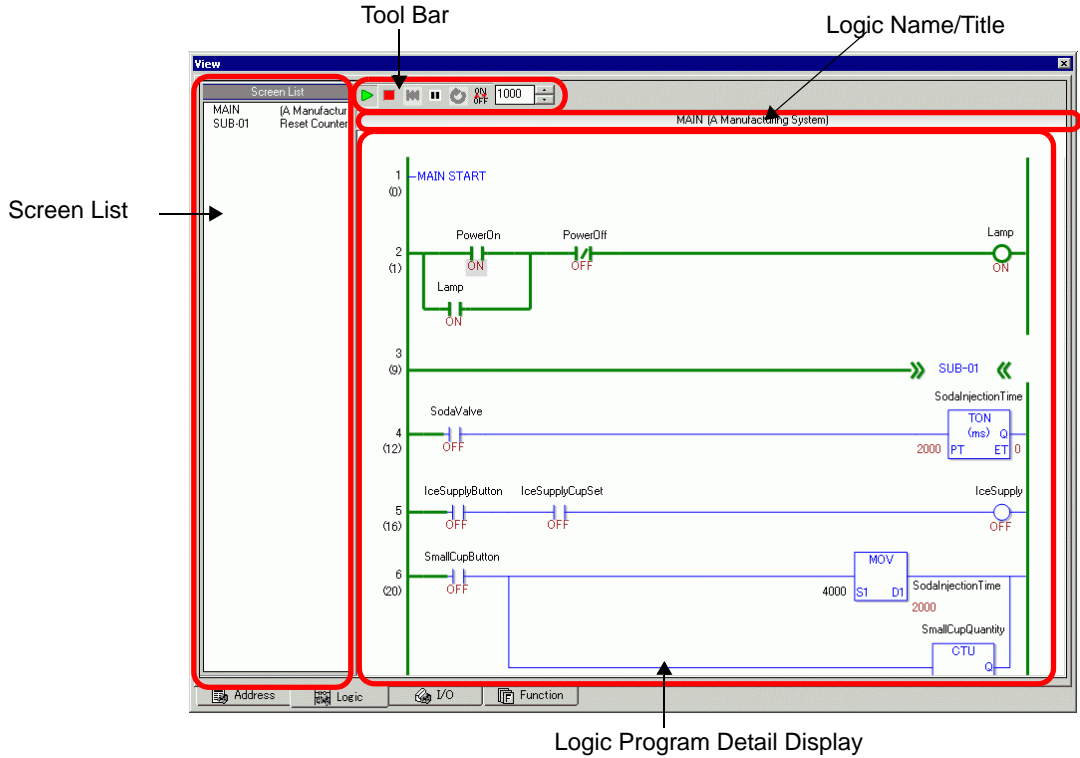

Setting	Description
Screen List	Displays the list of the logic names/titles of the logic programs created in the current edited project file. Double-click to display the logic program in the logic program display area.
Tool Bar	<ul style="list-style-type: none"> <li>▶ Runs the logic program.</li> <li>■ Stops the logic program.</li> <li>⏮ Resets the logic program.</li> <li>⏪ Pauses the logic program.</li> <li>🔄 Executes one scan of the logic.</li> <li>⏩ Enables/Disables the forced change.</li> <li>1000 ⏱ Specifies the scanning cycle of the logic.</li> </ul>
Logic Name/Title	The logic names and titles of the logic programs displayed on the logic program display area will be displayed.
Logic Program Display Area	Results of the simulation of the logic program selected in the Screen List are displayed. Green lines show the operating status. You can check/change ON/OFF and the current values of the symbol variables.

## 32.6 Restrictions

- To simulate a different project file, select [Simulation] from the [Project (F)] menu again.
- The contents that display in [Address View] matches the [Cross Reference (R)].  
You cannot display or change an address (including an indirect address) that does not display in [Cross Reference (R)].
- The following lists features unsupported in Simulation.

Feature	Details/Menu
System Menu	• [Offline], [CF Start], [IP Address], [RGB Settings], [Address Monitor], [Logic Monitor], [Device Monitor], [Ladder Monitor]
Offline	• Cannot display the offline screen.
Print Feature	• Printing alarm banner, alarm history, and sampling data, printing associated with CSV display parts, printing commands in scripts, and printing screen images does not work.
Bar Code Reader	• Cannot read in data from a bar code reader.
AUX Output	• Cannot run AUX Output.
Playing Movies	• The Movie Player does not display. • When using a [File Manager] part set to [Select Movie], the File Manager will not display. • The Save to CF or FTP and the Event Recorder functions do not work.
SRAM Backup	• All data stored in SRAM, such as alarm history, sampling data, recipes, internal device backup, and the Japanese FEP converter, is deleted when exiting Simulation.
Brightness/Contrast Settings	• The Brightness and Contrast adjustment bar does not display.
Reverse Display	• Even when [Reverse Display] is set in a Monochrome model, the display of the simulation is not reversed.
Standby Mode	• The Standby Mode function does not work.
Retentive Variables	• In the [Edit Symbol Variables] dialog box, even though the Symbol is set to Retentive, the data is erased when exiting Simulation.
Detect Backlight	• Detecting if the backlight is burned out does not work.
Remote PC Access	• The Remote PC Access Window Display does not display.
Change Backlight	• Changing the backlight color does not work.
Monitor	• Address Monitor, Logic Monitor, Device Monitor, and Ladder Monitor features do not work.
Cross-hairs Cursor	• The cross-hairs cursor feature does not work.
WinGP	• Device access APIs and handling APIs do not work, and error messages do not save.
Special Switch	• Operation Lock, Transfer Device/PLC Data

Continued

Feature	Details/Menu
Logic Feature	<ul style="list-style-type: none"> <li>• Logic, Scan Time, #L_Clock100ms, #L_Clock1sec, #L_Clock1min, Timer Instruction, PID Instruction, and Constant Number System may differ from the actual actions.</li> <li>• Watch Dog Timer, Logic Monitor, and Address Monitor features do not work.</li> <li>• The calculation system of Ladder Instructions may differ from the Display. (For example, Instructions dealing with real numbers, SCL Instructions, AVG Instructions)</li> </ul>
Online Monitor	<ul style="list-style-type: none"> <li>• Online monitor does not work.</li> </ul>
Transfer	<ul style="list-style-type: none"> <li>• [Transfer] tool's LAN/USB Transfer</li> <li>• [Memory Loader] tool's CF Card/USB Transfer</li> </ul>

- The SRAM backup data during simulation is cleared after you exit the simulation.
- Simulation does not work while WinGP is running.
- If the objects are other than [Symbol Variable], the variables which are not in use are not displayed in [Address View] of simulation, even if you have registered variables.
- There are restrictions for the current value of [I/O View] as follows.
  - Output operations cannot be performed.
  - Analog data of the FLEX NETWORK Driver can display to one decimal place.
  - When [Data Range] is set to [Fixed] in the EXM Driver (Model: EXM-AMM3HT), the operations for the higher and the lower limit cannot be performed.
  - When you select the STD, EXM, and CANopen drivers, I/O Driver-dependent display is not performed. Registered variables display and non-allocated terminals do not display.
- Some unsupported functions in the model may operate in the simulation because the simulation does not identify the display model (For example, a project file may have sound settings for models with sound output functions (AGP-3550T) and the model changes to another model (AGP-3500T). When the project is simulated, the sound output function operates. However, the sound output function does not run when this project is transferred to the GP. See the following description of the support function for each model.
  - ☞ "1.3 Supported Features" (page 1-5)
- You cannot directly input the device address to [Watch List] on [Address View].
- You cannot display or edit D-Script temporary addresses.
- You can simulate the read-write function to CF or USB by D script.
- The read only or write only addresses allow you to read or write.
- The virtual device/PLC backup file cannot be read when a simulation of a different project file is running, or when the device/PLC configuration has changed in the same project file. The simulation is activated without the previously stored data.
- When running screen captures, files are stored in the following location:  
C:\Program Files\Pro-face\GP-Pro EX \*\*\*\CFA00\CAPTURE (\*\*\*) stores the version number)
- You can only use up to 320KB of the SRAM at simulation for PC/AT Series, PS Series, and PL Series.

- When setting the display orientation to [Portrait], the display is rotated 90-degrees when you perform the simulation.

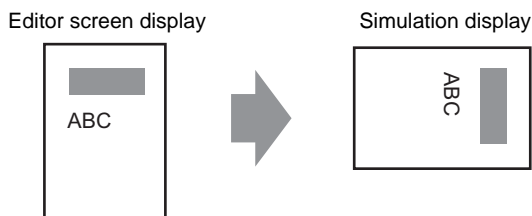

- When the installation destination of the GP-Pro EX has more than 200 letters and a simulation is activated, the error message "You cannot activate the simulation because the maximum number of letters has been exceeded" appears. The simulation does not run normally. Reinstall the GP-Pro EX to an installation destination with path of less than 200 letters in English one byte characters.
- You cannot exit GP-Pro EX while executing a simulation. Exit simulation first.
- You can run Simulation on one project at a time.
- During Simulation, if you use the [Display] menu's [Option Settings] command to change the language settings, an error message prevents the operation. To change the language, you need to exit Simulation.
- The communication scan value is always set to zero because the simulation does not communicate with the device/PLC. The communication status information is not received correctly in the simulation.
- In the [Display Unit]'s [System Area] tab, if the [System Area Start Address] is not set up, the project cannot display the System Area data.
- If the project does not pass the error check (from the [Project (F)] menu point to [Utility (T)] and select [Error Check (E)]), it will not run in Simulation.
- With Microsoft Windows XP Service Pack 2, when you start Simulation it may display an error message indicating that the Windows firewall is blocking the application. In that case, select [Release Block] and continue with the Simulation operation.
- In Simulation, you cannot set up clocks or calendars that use the System Area or system variables.
- When writing data to PLC devices with D-Script, the writing results are not reflected immediately, because it takes some time to communicate with GP units. But the writing results are immediately reflected in the simulation. If you create D-Script taking into account the time lag to write data to PLC devices, simulation results may differ from the actual operation on the GP units.
- If you allocate the switch functions to function keys of the keypad with WinGP, the function keys of the keypad connected to the PC are disabled. After performing the simulation on IPC using function keys of IPC, the keypad connected to the PC is disabled.
- Restrictions on the [Logic View] are as follows.
  - Online edit, PID monitor, and logic edit are not allowed.
  - You cannot display the list of the current values. Please use [Address View].
- Operation switches for handy type GPs can function only as normal function keys. It does not work when you press multiple function keys at the same time.

