

34 | Print

This chapter explains how to print screens and project settings from the GP-Pro EX editor, and how to print data and display screens from the GP.

Please begin by reading "34.1 Settings Menu" (page 34-2) and then turn to the corresponding page.

34.1	Settings Menu	34-2
34.2	Printing the Project Settings.....	34-4
34.3	Printing GP data.....	34-9
34.4	Printing the Current Screen (Screen Hard Copy).....	34-27
34.5	Cancel Printing.....	34-37
34.6	Settings Guide.....	34-47
34.7	Restrictions	34-68

34.1 Settings Menu

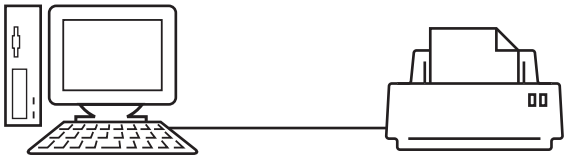
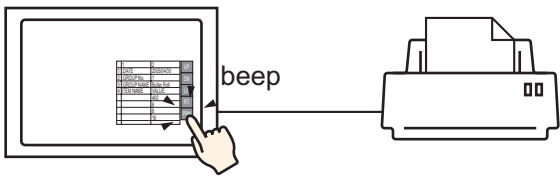
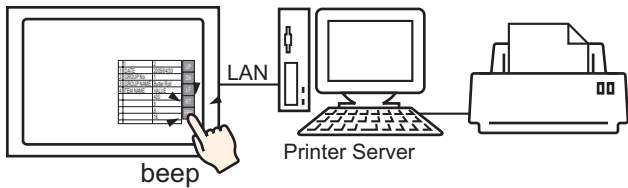
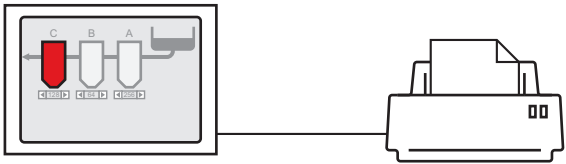
Printing the Project Settings	
<p>Use GP-Pro EX to print projects from a PC.</p>  <p>NOTE</p> <ul style="list-style-type: none"> You can output the project settings to a file. 	<ul style="list-style-type: none"> ➤ Setup Procedure (page 34-5) ➤ Introduction (page 34-4)
Printing GP data	
<p>Print various data in GP (Alarm History data, Sampling data, and so on) by connecting the GP to a printer.</p> 	<ul style="list-style-type: none"> ➤ Setup Procedure (page 34-14) ➤ Introduction (page 34-9)
<p>Print GP data over the network to a computer's printer.</p> 	<ul style="list-style-type: none"> ➤ Setup Procedure (page 34-14) ➤ Introduction (page 34-9)
Printing the Current Screen (Screen Hard Copy)	
<p>Prints the displayed screen on the GP as it appears.</p> 	<ul style="list-style-type: none"> ➤ Setup Procedure (page 34-30) ➤ Introduction (page 34-27)

Cancel Printing

You can cancel the printing of data and display screens. If you cancel, all the print processes being performed are canceled.

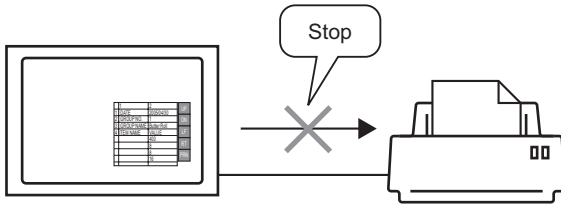

- ☞ Setup Procedure (page 34-40)
- ☞ Introduction (page 34-37)

34.2 Printing the Project Settings

34.2.1 Introduction

You can print the project settings for a file from GP-Pro EX. This feature is useful for debugging and documenting projects.

Also, you can output them in the rich text file (*.rtf) format.



Print Example

```

Project Setting(Summary)
2005/10/28 11:31 test.prx

Summary
Project Name          test.prx
Last Saved Date and Time  Fri Oct 28 11:24:41 2005
Creator              Pro-face
Title
Send Data Size       75843 Bytes
Model               AGP-3500T
Device/PLC 1

Printer
Bar Code 1
Bar Code 2
Script 1
Script 2

Common Setting(Sampling)
2005/10/28 11:33 test.prx

Sampling Settings
Language Settings/Font Type  ASCII Standard Font
Sampling Settings (Detail)
Group                        Group
Addressing                   Sequential
Sampling Top Address         [PLC1] D00100
No. of Sampling Words       1
Bit Length                   16Bit
Execution Condition          Time Specification
Sampling Permit Bit Address  [PLC1] M000100
Start Time                   00:00
End Time                     00:00:00
Sampling Cycle               00:00:00
No. of Times                 1 Times
Data Full Bit Address        Disable
Data Clear Bit Address       [PLC1] M000050
Backup to SRAM               Enable
Overwrite from the oldest data Enable
No. of Days                  1
Time Data                    Enable
Data Valid/Invalid Flag     Enable
Display/Save in CSV Settings Disable
Print Settings               Disable
Write Data Settings          Disable
    
```

34.2.2 Setup Procedure

NOTE

- Please refer to the Settings Guide for details.
 ☞ "34.6.1 [Print Setup] Settings Guide" (page 34-47)

Output the Project Information, Alarm Settings, and Sampling Settings from a PC to a printer.



- 1 Select the [Project (F)] menu and choose the [Print (P)] command or click [Print Settings (S)] to open the [Print Settings] dialog box.

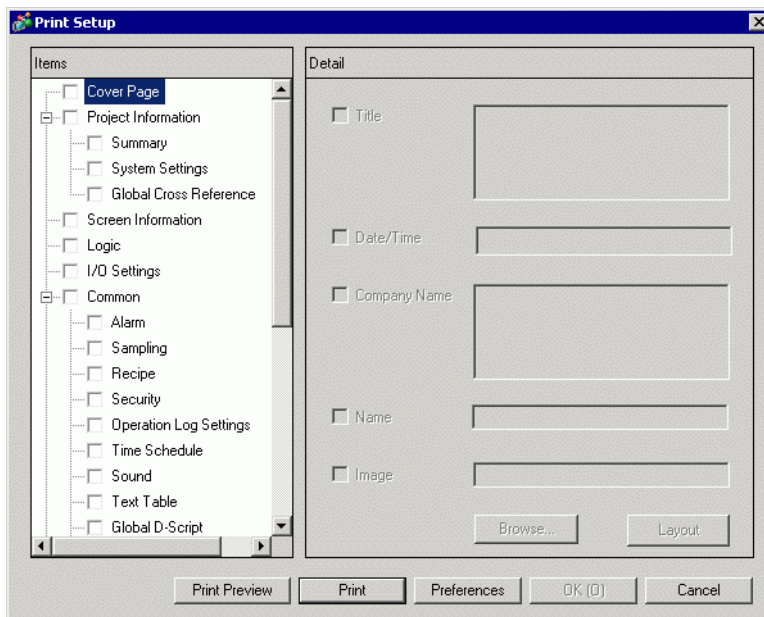

- 2 Select the [Project Information] check box to select all the sub items. (For example, [Summary], [System Settings], [Global Cross Reference])

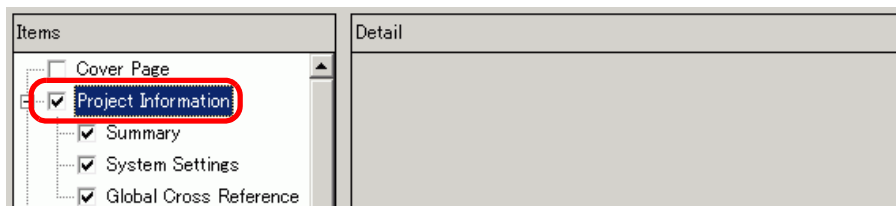

3 Under [Common], select the [Alarm] check box. Select all the Alarm boxes to print in [Items] (for example, [Common], [Alarm History]).

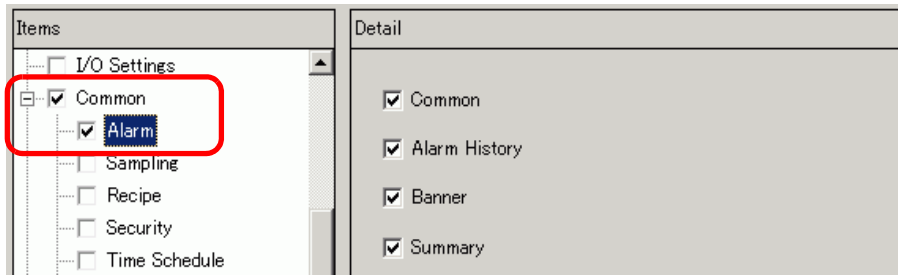

4 Under [Common], select the [Sampling] check box. Select [Detail] for the Sampling [Print Contents].

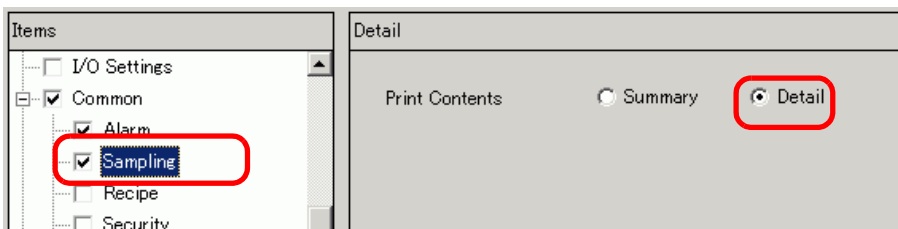

5 Click [Print Preview] and check the print status.

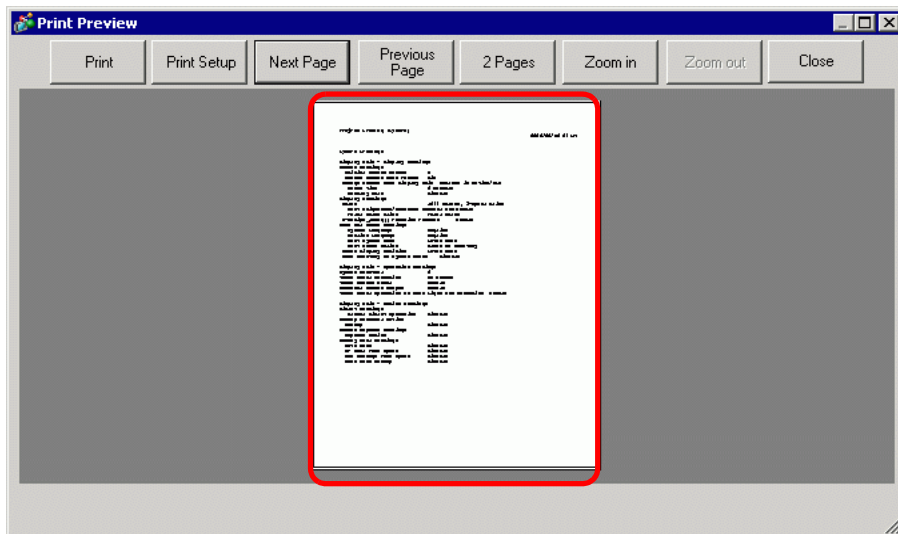

[Print] can be clicked to open the [Print] dialog box.

6 [Printer Name (N)] field, select the printer and click [Print] to begin printing.

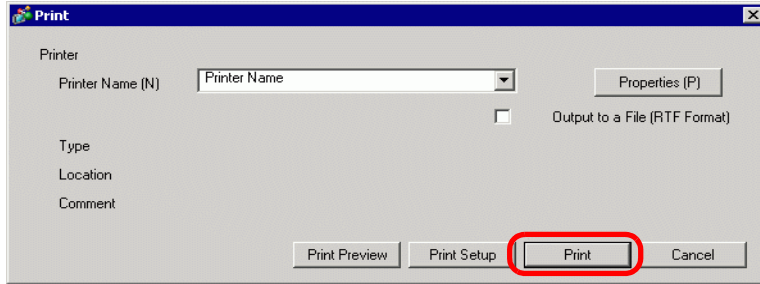

To output to a rich text file without printing, select the [Output to a File (RTF Format)] check box.

Click [Print] and the following dialog box appears. Select the [Save in] location and [File name] and click [Save].

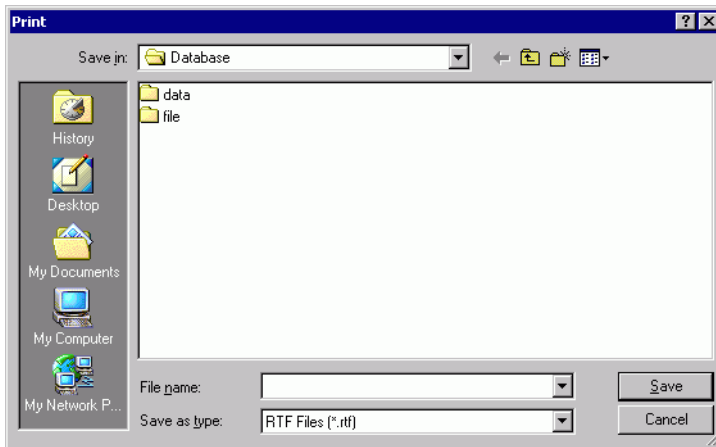

34.2.3 Print Layout

For example, Project Settings

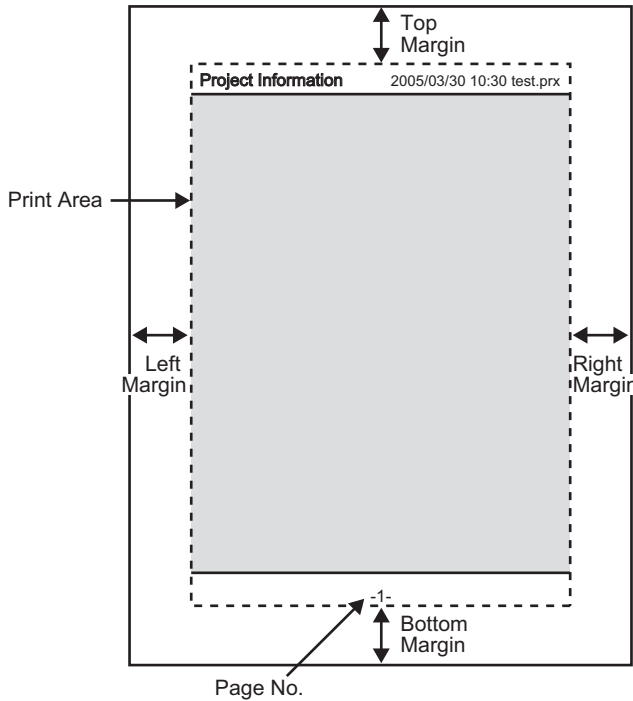

- The print item name is printed on the top left corner, and the printout date/time and the project file name on the top right corner.
- A page number can be set in Preferences.

For example, Cover Page

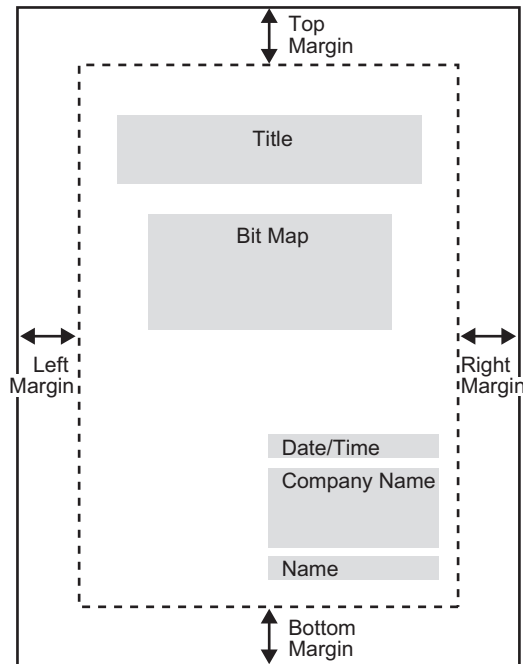

- Image files can be placed from the line after Title to two lines before Date/Time. When printing an image that exceeds this area, the image is automatically reduced to fit into the area.
- Bitmap images can be moved within the print area.

34.3 Printing GP data

34.3.1 Introduction

You can print GP data such as Alarm History data and Sampled Data over the network to a computer's printer.

■ Connecting Directly to a Printer

You can print GP data by connecting a printer directly to the GP. You can connect one printer to the GP at a time.

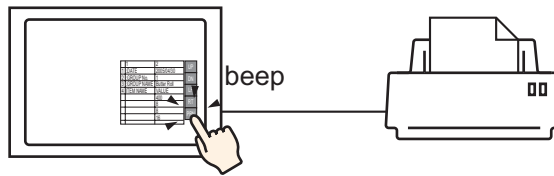

■ Printing Over the Network to a Computer Printer

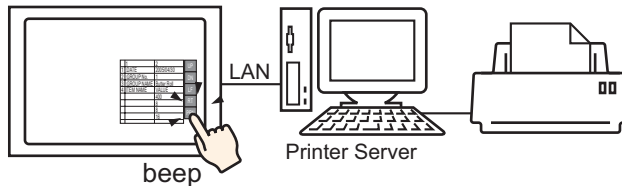

When the GP is connected to a computer over the network, you can print to the computer's printer if the computer is set up as a printer server. Install "GP Remote Printer Server" to the connected computer.



NOTE

- Limited models can use "GP Remote Printer Server". Refer to the following.
 ☞ "1.3 Supported Features" (page 1-5)

Data that can be printed from GP is as follows.

Feature	Print Contents
Screen Hard Copy	<p>Prints the displayed screen on the GP as it appears.</p> <p> "34.4 Printing the Current Screen (Screen Hard Copy)" (page 34-27)</p>
Alarm Banner	<p>Prints an alarm message in the displayed language (table) when it triggers or recovers.</p> <p>NOTE</p> <ul style="list-style-type: none"> • [GP Remote Printer Server] doesn't support Real-time Printing. When the printer receives printing instructions, it prints one sheet per line.
Alarm History	<p>Real-time Print Prints when an alarm triggers, is confirmed, or recovers.</p> <p>NOTE</p> <ul style="list-style-type: none"> • [GP Remote Printer Server] doesn't support Real-time Printing. When the printer receives printing instructions, it prints one sheet per line. <p>Batch Print Prints all the alarm history in a specified format when a specified [Print Word Address] Bit 0 is turned ON.</p>
Sampling	<p>Real-time Print Prints in the print format specified in [Sampling] each time it collects data.</p> <p>NOTE</p> <ul style="list-style-type: none"> • [GP Remote Printer Server] doesn't support Real-time Printing. When the printer receives printing instructions, it prints one sheet per line. <p>Batch You can print in Block units when in the [Sampling] screen's [Mode] tab, [Extended] settings area, the [Overwrite old data after finishing the specified cycles] check box is cleared. Prints the collected data in block unit in a specified print format when a specified [Print Word Address] Bit 0 is turned ON.</p>
Printing CSV Data	<p>Prints the displayed CSV data when you touch the print key on a special data display [Show CSV]. You can select whether to print only the displayed portion or to print the whole data.</p> <p> "25.6 Displaying/Editing CSV data on the Screen" (page 25-29)</p>
Script Printer Output	<p>When printer operation functions are run from D-Script, Global D-Script, and Extended Script, only the specified bytes are printed. This type of printing is not supported by the [GP Remote Printer Server].</p>

NOTE

- Some printers used cannot print Alarm History and Sampling per line in real-time printing. This is because the printers don't support paper feed per line.
-

◆ **GP Supported Printer Types**

You can use the following printers.

- NEC PC-PR201/PL command compatible
- EPSON ESC/P24-J84 (C) command compatible
- HP Laser Jet PCL 4 command compatible
- Some models of EPSON PM/Stylus (6 Colors) and Stylus (4 Colors)

For supported printer models, refer to the Pro-face support site "Otasuke Pro!" (<http://www.pro-face.com/otasuke/>).

Connect to this site by clicking the [Help (H)] menu and choose the [Connect to Support Site - "Otasuke Pro!" (O)] command.

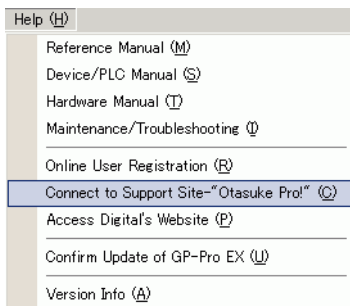

IMPORTANT

- Supported models may change due to GP upgrades.
 - Printing may not work if you use an unlisted printer as a supported model. Make sure your printer is compatible before you begin.
-

NOTE

- You cannot use a Windows only printer with GP. Please use the command-compatible machines listed above or equivalent printers.
-

◆ **Printers and Interfaces**

A printer is connected by using any of COM1(RS-232C), COM2 (RS-232C), USB, USB/PIO, or LAN.

The USB connection supports USB direct, and USB-PIO conversion.

The following interface corresponds to each printer.

		Interface			
		COM1/2	USB Direct	USB/PIO	LAN (LPR/IPP)
Printer	NEC PR Series	O	X	O	O
	EPSON ESC/P (High Speed)	O	X	O	O
	EPSON ESC/P (High Quality)	O	X	O	O
	HP LASERJET Series	O	X	O	O
	EPSON PM/Stylus (6 Colors)	X	O	O	O
	EPSON Stylus (4 Colors)	X	O	O	O
	GP Remote Printer Server	X	X	X	O
	Text ASCII	O	X	X	X

NOTE

- Use a USB/PIO converter to connect a Centronics parallel interface printer. For supported USB/PIO converters, refer to the Pro-face support site "Otasuke Pro!"(<http://www.proface.com/otasuke/>).
- For USB direct connections, confirm the supported models. A complex printer with a scanner and storage cannot be used for USB direct printing.
 "◆ GP Supported Printer Types" (page 34-11)
- When printing with LAN connection, there may be a short delay before the print starts.
- [GP Remote Printer Server] displays in the list only when a Ethernet connection supported model is selected.

Output Port and Printing Features

Print Feature	COM1	USB	LAN	GP Remote Printer Server
Screen Hard Copy	O	O	O	O
Alarm (Banner) Print	O	O	X	X ^{*1}
Alarm (History) Real-time Print	O	O	X	X ¹
Alarm (History) Batch Print	O	O	X	O
Sampled Data Real-time Print	O	O	X	X ¹
Sampled Data Batch	O	O	X	O
Printing CSV Data	O	O	X	O
Script Printer Output	O	O ^{*2}	X	X

*1 Alarm banner and Real-time printing are not supported. When the printer receives printing instructions, it prints one sheet per line.

*2 Script printer output with USB connection supports only USB-PIO conversion.

◆ **Operating Environment for the GP Remote Printer Server**

To use a computer with a LAN connection as a printer server, install "GP Remote Printer Server".

☞ " Settings for Remote Printer Server Printer" (page 34-23)

The operating environment for "GP Remote Printer Server" is as follows.

	Required Specifications	Remarks
Display	<ul style="list-style-type: none"> • GP3000 Series with Ethernet support (except GP3200 Series) • LT Series with Ethernet support 	☞ "1.3 Supported Features" (page 1-5)
Operating System	Windows [®] 2000 (Service Pack 3 or later), Windows [®] XP (Professional), Windows [®] Server 2003	
Hard Disk Capacity	800 KB or more	This capacity is required to install Movie Converter.
Language	English, Japanese	
LAN port	100Base-T	
FTP Server	IIS Included FTP ServerComponent	IIS version <ul style="list-style-type: none"> • Windows[®] 2000: IIS5.0 • Windows[®] XP: IIS5.1 • Windows[®] Server 2003: IIS6.0
Others	.NET Framework Ver.1.1 (Service Pack 1) or later	Automatically installed in a computer without NET Framework Ver.1.1 (Service Pack 1) or later. For information about the disk space required, please refer to the Microsoft home page.

34.3.2 Printer Setup Procedure

NOTE

- Please refer to the Settings Guide for details.
 ☞ "34.6.2 System Settings [Printer] Settings Guide" (page 34-63)

■ Connecting a Printer Directly to GP

Configure settings to connect the GP and a printer using a USB-PIO converter.

1 Select [Printer] from the System Settings window.

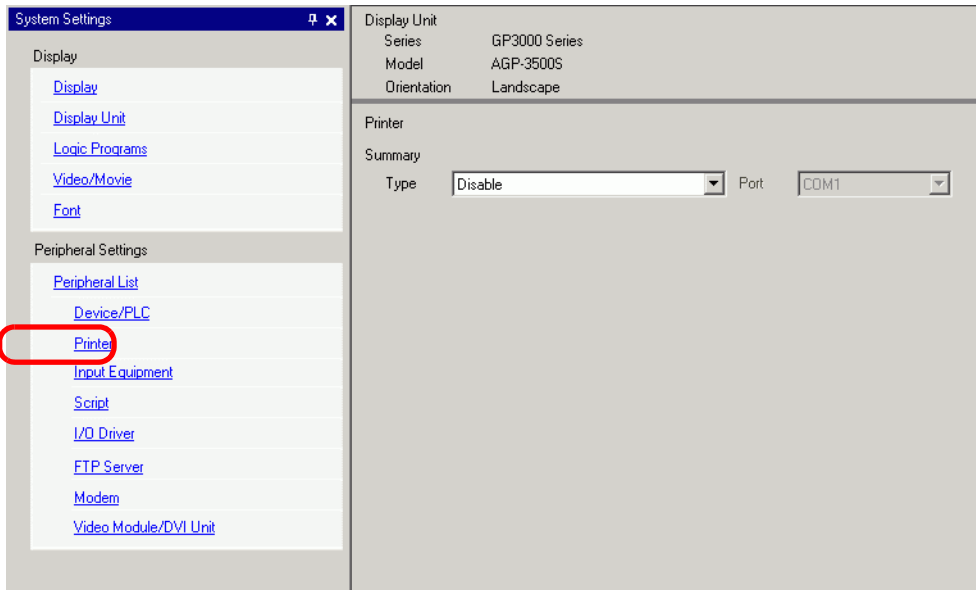

NOTE

- If the [System Settings] tab does not display in the workspace, select the [View (V)] menu, select the [Work Space (W)] option, and choose the [System Settings (S)] command.

2 Configure the printer type to use and the output port. (For example, [Type] EPSON PM/ Stylus 6 Color, [Port] USB/PIO)

NOTE

- If the port is being used by another device, the  mark displays next to the box. Select a port that is not used by another device/PLC.

- 3 Configure the output settings. Configure the [Print Method], [Rotate Screen], [Print Scale], [Reverse Black/White], [Paper Size], [Paper Orientation], and [Top Margin].

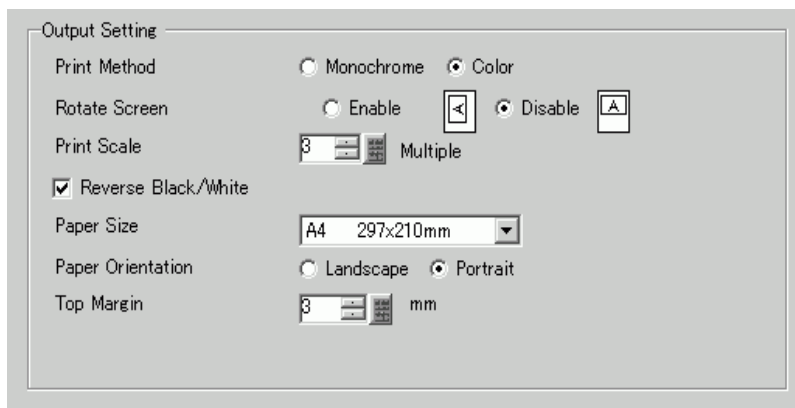

The printer connection settings are complete.

Connect the printer to the GP with a specified output port (USB/PIO) and configure print settings for each feature. The printer starts.

NOTE

- For a monochrome GP model, the print will be monochrome even if [Color] is selected for the [Print Method].

■ Printing from GP, Over the Network, to a Computer Printer

When using a PC connected over the network as a printer server, define the printer settings. You can install [GP Remote Printer Server] driver on a computer even without GP-Pro EX installed.

For settings, please follow the procedure below.

◆ Connection of a device

Use Ethernet to connect a PC to GP.

Also, please connect a printer to the PC and while referring to the manual of device that you are using, and be sure that a text file or image file can be printed without any problem.

NOTE

- The PING command can verify the connection between GP and the PC. For more details on the PING command, refer to:

☞ 1.2.6 パススルー機能でパソコンと交信できません 1-40

◆ Installation and setting of an FTP Server

In the PC on which to install the GP Remote Printer Server, you need to install and set up an FTP server beforehand.

To install and set up an FTP server, you need to login with Administrator authority.

NOTE

- See the following for information about Administrator authority.
 1.2 パソコン操作で困った！ 1-4

Install an IIS FTP Service

1 Select [Add/Remove Programs] - [Add/Remove Windows Component] in the control panel to display the [Windows Component Wizard].

NOTE

- If you are using Windows® 2000, select [Add/Remove Application] - [Add/Remove Windows Component].

2 Select [Internet Information Service (IIS)] and click the [Extended] button.
 3 Check [FTP (File Transfer Protocol) Service] and press the [OK] button.

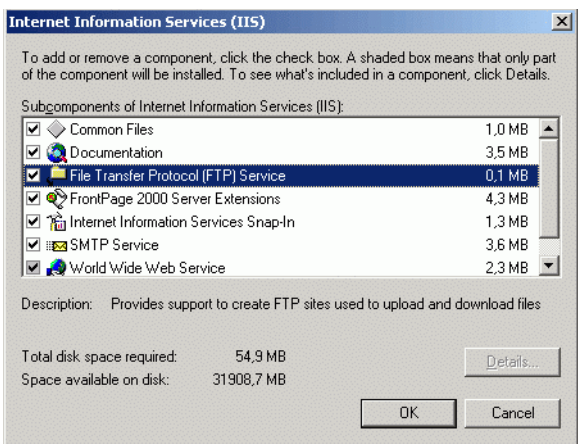

4 Press [Next] in the [Windows Component Wizard] and install.

NOTE

- A Windows installation CD may be required. Insert a CD as instructed.

Settings for IIS FTP Service

1 Open [Administrative Tools] - [Internet Information Service] from the control panel and select [Default FTP site].

NOTE

- If the [Default FTP site] cannot be found, IIS FTP Service is not installed. Install while referring to the following.
 " Install an IIS FTP Service" (page 34-16)

2 Right-click the [Default FTP Site] to open [Properties].

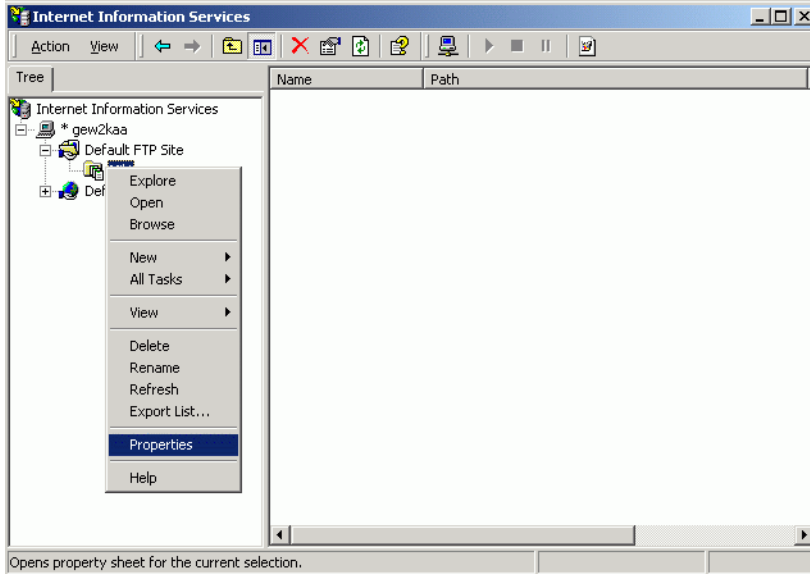

3 Open the [FTP Site] tab, and enter the IP address of the computer in the [IP Address] field. (For example, [IP Address] 192.168.1.31)

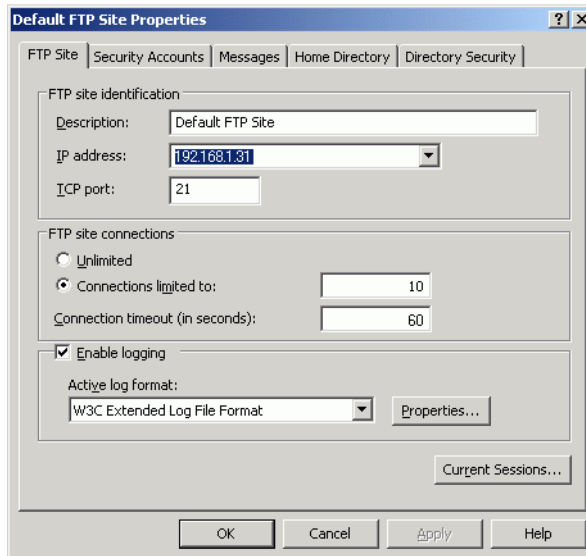

4 Open the [Home Directory] tab, and check the [Read] and [Write] fields.

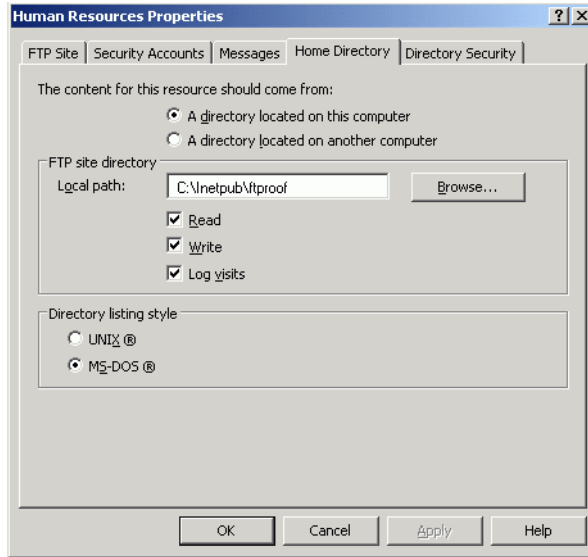

5 Click [OK] and close [Property].

6 Right-click the [Default FTP Site] and click [Begin].

Create a User for FTP Login

You need to prepare a user account for FTP login. You can also use an existing local user. This section provides the procedure for creating the new local user, "FtpUser".

- 1 Open [Administrative Tools] - [Administration of Computer] from the control panel.
- 2 Right-click [Local User and Group] - [User] to open [New User].

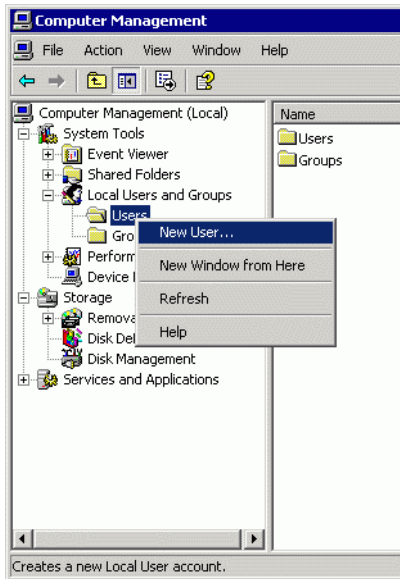

- 3 Enter the User name and password to create a new user. Clear the [User needs to Change Password for the Next Login] check box.

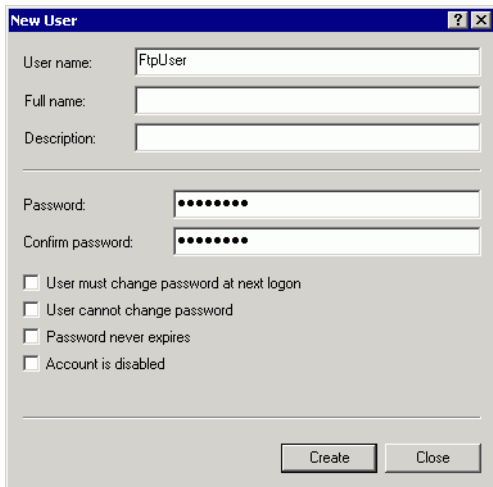

Check Operation of FTP Server

To check operation, execute on a computer other than that of the server.

- 1 Open [Program] - [Accessory] - [Command Prompt] from Start menu.
- 2 Enter "ftp", space, and the IP address of the FTP Server (in this case, "192.168.1.31") at the Command Prompt, and press the Enter key.

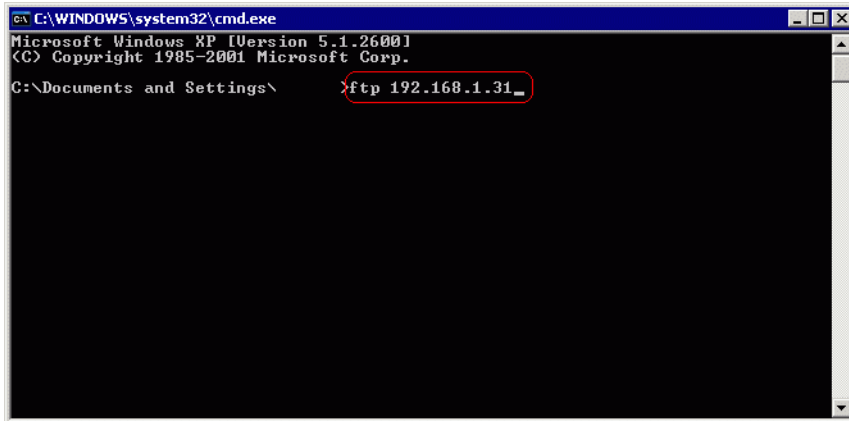

- 3 Enter the User name of the FTP login user (in this case, "FtpUser") and the password. While entering password, the cursor will not move.

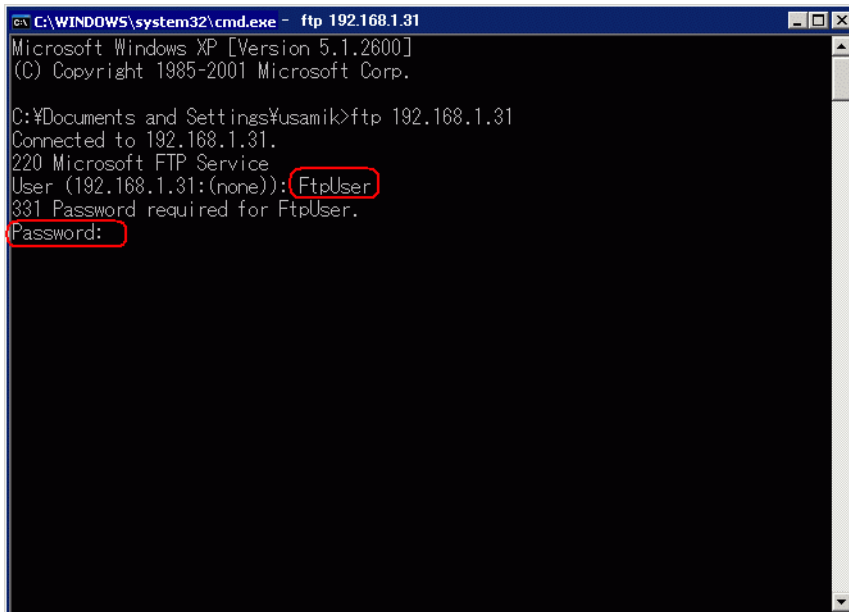

4 If the message, [230 User FtpUser logged in], appears, the operation was successful.

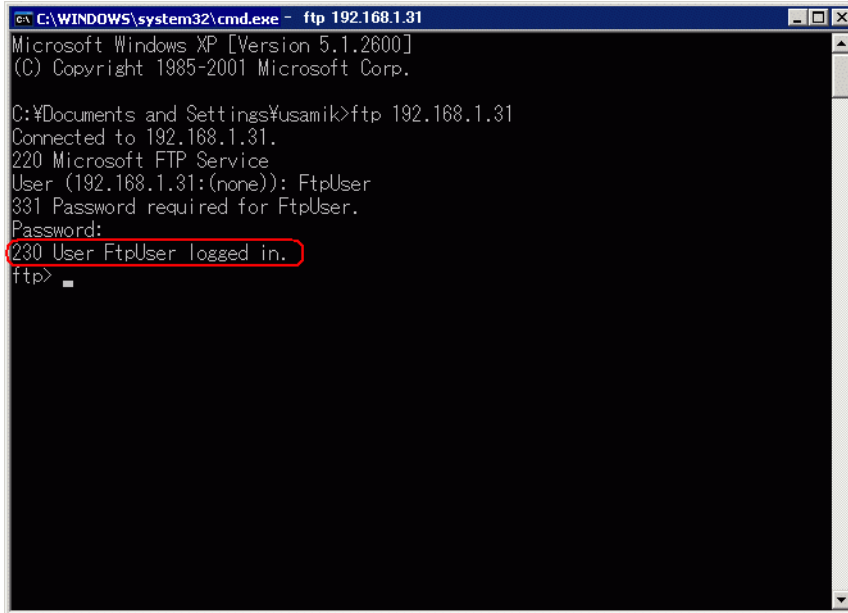

NOTE

- If you are using Windows® XP, and are not properly logged in, there may be a possibility that the firewall is enabled. Disable the firewall and try again.

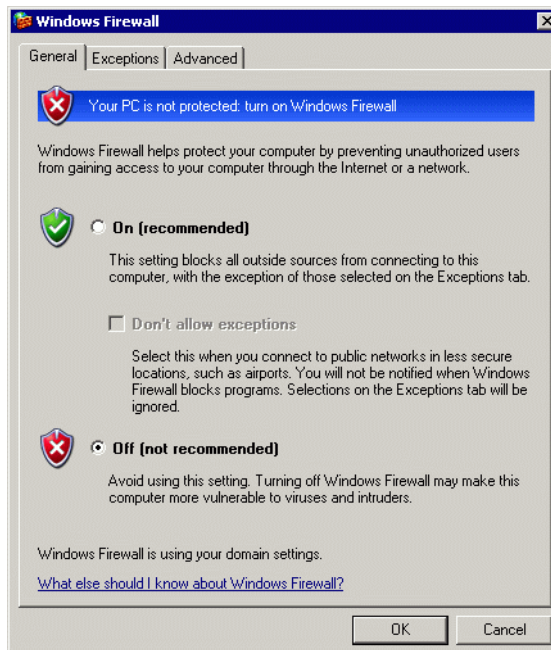

◆ Install the GP Remote Printer Server

To install the GP Remote Printer Server, first login with Administrator permissions.

Setting Up a User for the Remote Printer Server

You need to prepare one user account for the Remote Printer Server.

NOTE

- You can set up a user other than the user created in <Creation of FTP Login User>.
- You can set up a user other than the user that is currently logged in.

A user for Remote Printer Server needs to be given Administrator permissions and [Login as a Service] authority.

Use the following procedure to set [Login as a Service] authority.

- 1 In the Windows Control Panel, double-click [Administrative Tools] and open [Local Security Policy] to display the [Local Security Settings].
- 2 To confirm that the defined user is registered, double-click [Local Policy], open [User Rights Assignment], then open [Log on as a service] and check that the user is registered.

NOTE

- If you are not registered, click [Select User or Group] and add from the displayed screen.

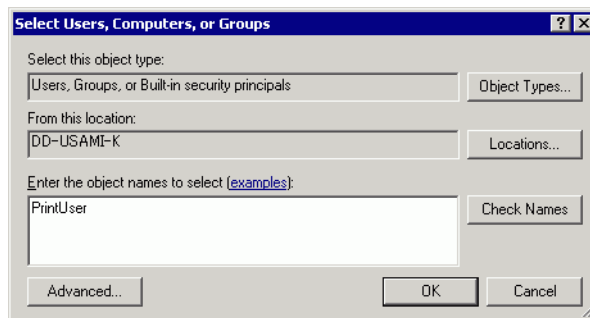

Settings for Remote Printer Server Printer

- 1 Log in to computer with the user for Remote Printer Server.
- 2 Open [Printer and Fax] in the control panel and right-click the printer that you want to use for printing, and select [Set as the Default Printer].

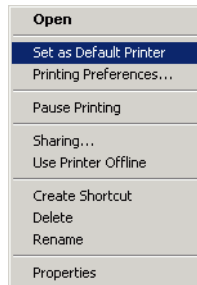

- 3 Set Installation CD-ROM (Disk2) of GP-Pro EX in the CD-ROM drive of the computer to be used as a printer server.
When the GP-Pro EX setup screen displays, click [GP Remote Printer Server].

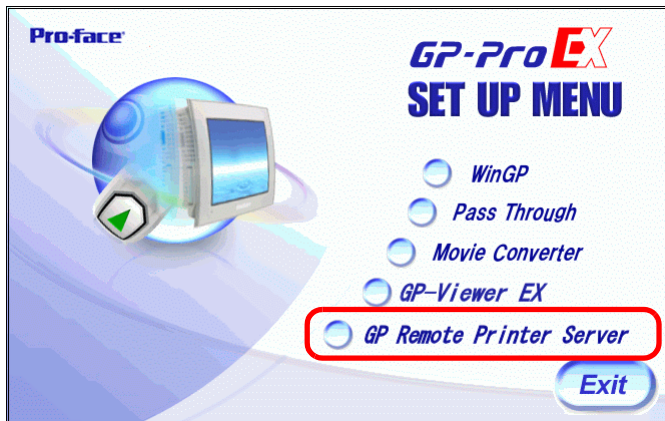

- 4 Once installation begins, follow the instructions on the screen.
- 5 The following screen displays when installation is complete.
Set a [UserName] for the computer to be used as a printer server, and a [Password] for login, and click [Install].

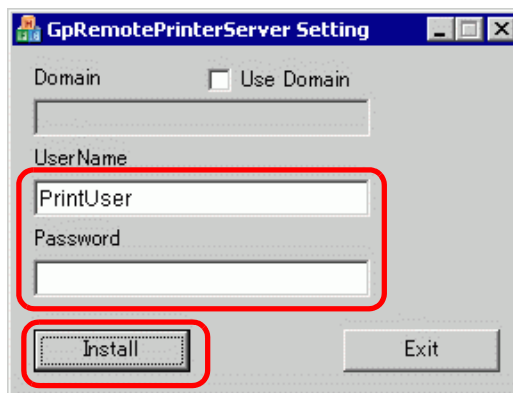

NOTE

- A user-defined "default printer" is used for printing.
- For [UserName] and [Password], enter the user account for the Remote Printer Server.
- ☞ " Setting Up a User for the Remote Printer Server" (page 34-22)
- If a user for the Remote Printer Server is a domain user, check [Use Domain] and enter a domain name in the [Domain] field. If you right-click my computer and select [Property] to display the [System Property] window, and select the [Computer Name] tab, you can check the domain name.
- To check whether the account in use is a domain user, press the [Ctrl] + [Alt] + [Delete] keys while logged in to display the [Window Security] screen. If a computer name in use appears before [User Name], the account in use is a local user.



- If you right-click My computer, and click [Property] to display the [System Property] window, and select the [Computer Name] tab ([Network ID] tab if you are using Windows[®] 2000), you can check the computer name.

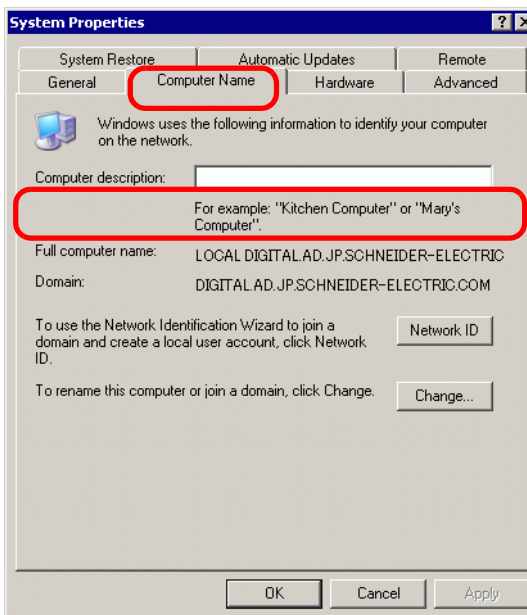

6 When the GP-Pro EX setup screen displays, click [Exit] to close the screen.

◆ For GP-Pro EX

7 Select [Printer] from the System Settings window.

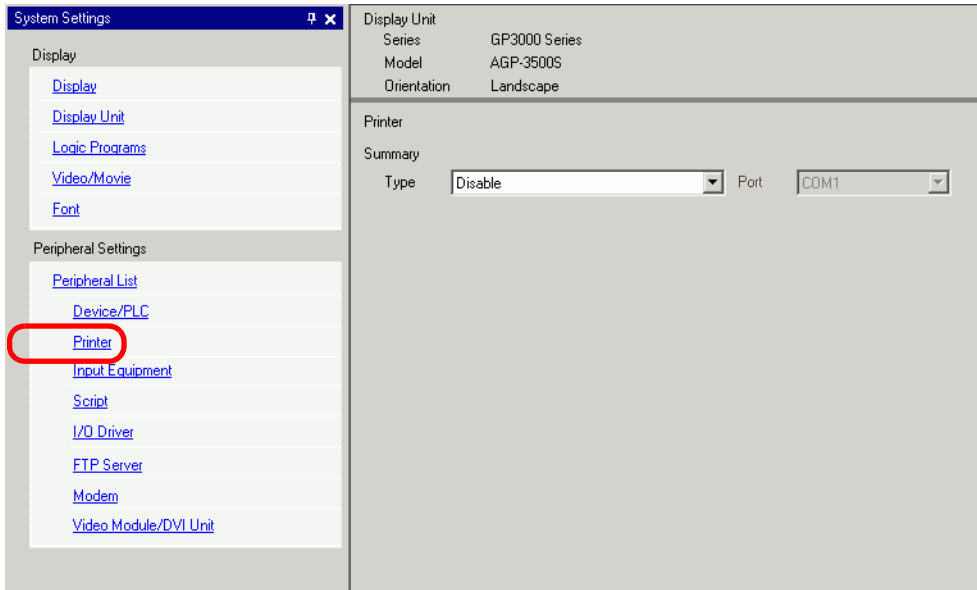

NOTE

- If the [System Settings] tab does not display in the workspace, select the [View (V)] menu, select the [Work Space (W)] option, and choose the [System Settings (S)] command.

8 Select [GP Remote Printer Server] as the printer type.

NOTE

- When [GP Remote Printer Server] is selected, the following message displays.

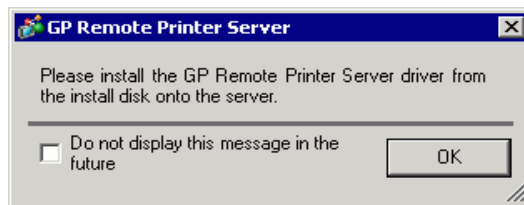

- If the selected model does not support Ethernet connections, [GP Remote Printer Server] cannot be selected as the Printer Type.

9 Configure the print output: [Paper Size], [Orientation], [Print Size] and printer [Margin].

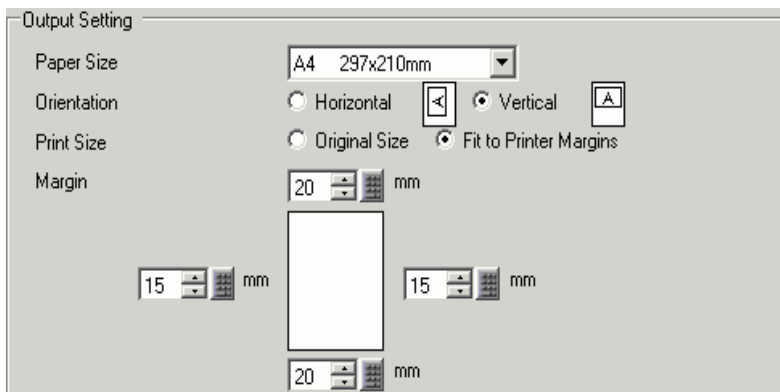

10 Configure the communication settings: Set the [IP Address] of the connected computer, [Port] for FTP connections (here "192.168.1.31"), [User Name] (here "FtpUser") and [Password].

NOTE

- For [User Name] and [Password], enter the user account that you created for FTP login.
- " Create a User for FTP Login" (page 34-19)
- The maximum number that you can enter in the [User Name] field is 20.

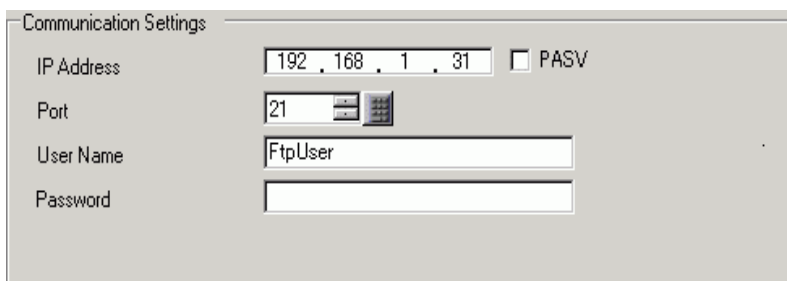

The printer connection settings are complete.

Printing begins when the GP and printer server are connected with Ethernet cables and each feature's print settings are defined.

34.4 Printing the Current Screen (Screen Hard Copy)

34.4.1 Introduction

Prints the GP screen contents as an image.

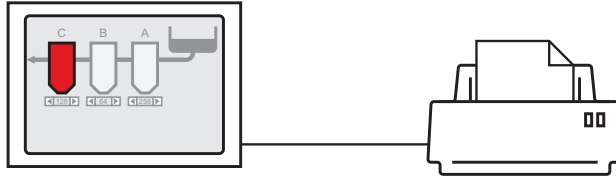

Print Example

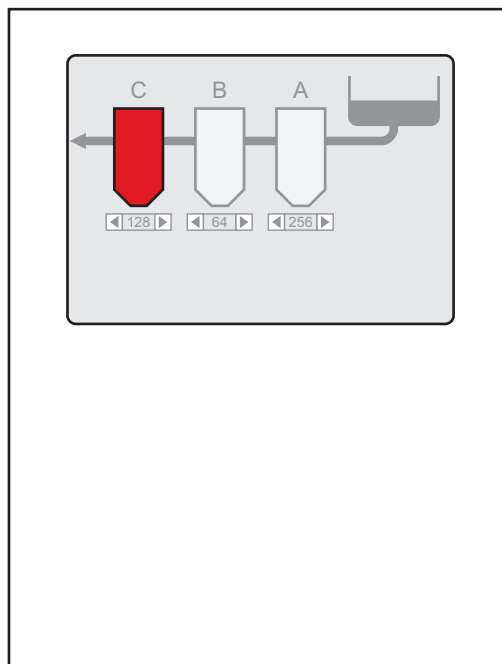

NOTE

- The method of printing the screen display depends on the communication method (direct access or memory link).
 - You can save the currently displayed screen as a JPEG file to a CF Card, USB storage device, or FTP server.
- ☞ "11.6 Saving the Displayed Screen" (page 11-18)
-

34.4.2 Operation Method

The following methods are used to start printing the displayed screen. The operation method differs depending on the communication method (direct access or memory link).

IMPORTANT

- For more details on the communication method, refer to:
 - ☞ "A.1.2 Communicating with a Device/PLC Using the Direct Access Method" (page A-4)
 - ☞ "A.1.3 Using the Memory Link Method with Unsupported Devices/PLCs" (page A-6)

■ Direct Access Method

Operating by Screen Touch ☞ "◆ To Trigger Printing the Current Screen by Touch" (page 34-30)

If you turn ON the GP internal device LS14 (control address) Bit 2 (print start bit) using a switch, the current screen will print.

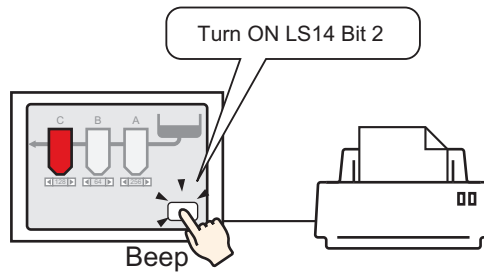

Operating from a Device/PLC ☞ "◆ To Trigger Printing the Current Screen from a Device/PLC" (page 34-32)

If you turn ON control address Bit 2 in the system data area allocated to a device/PLC, the displayed screen will print.

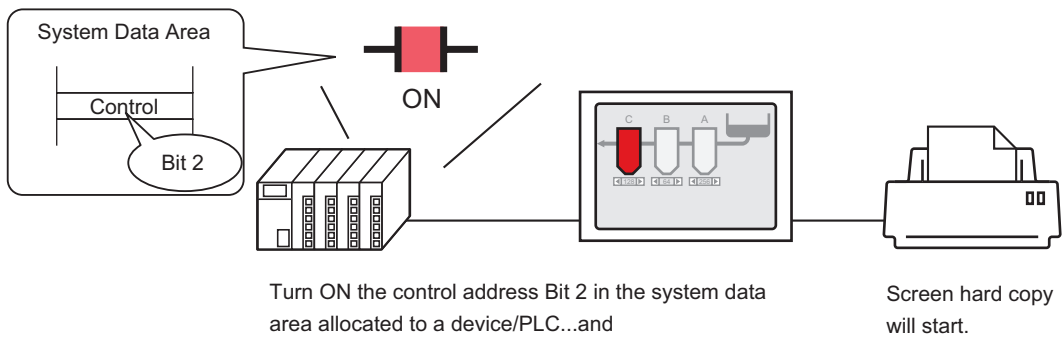

■ Memory Link Method

Operating by Screen Touch  " ◆ To Trigger Printing the Current Screen by Touch" (page 34-33)

In the GP internal device (#MEMLINK), if you use a switch to turn ON '0011' (control address) Bit 2 (print start bit), the current screen will print.

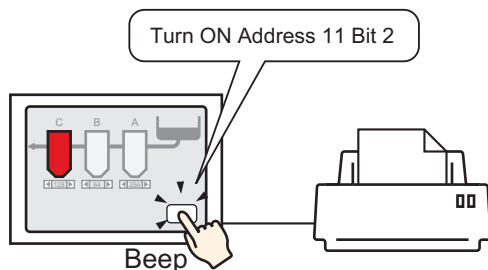

Operating from a Host (PC)  " ◆ To Trigger Printing the Current Screen from a PC Host" (page 34-36)

If you send the command to write '0004h' to '0011' (control address) from a host (PC), the current screen will print.

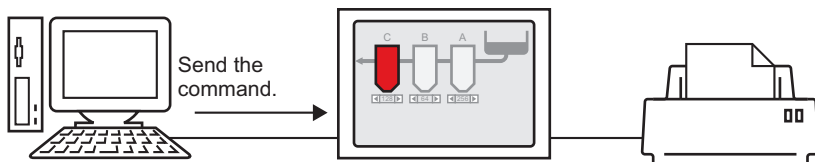

34.4.3 Setup Procedure

■ Direct Access Method

◆ To Trigger Printing the Current Screen by Touch

NOTE

- For details of the part placement method and the address, shape, color, and label setting method, refer to the "Part Editing Procedure".
 ☞ "8.6.1 Editing Parts" (page 8-44)

Create a switch to operate the internal device LS14 bit 2.

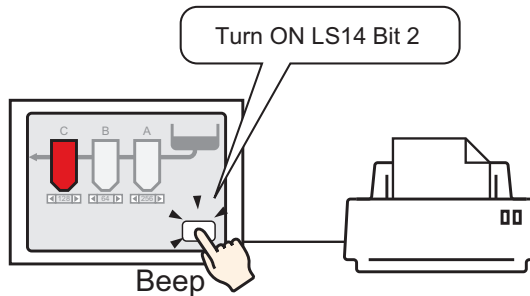

1 Configure connection settings for the printer.

☞ "34.3.2 Printer Setup Procedure" (page 34-14)

2 From the [Parts (P)] menu, select [Switch Lamp (C)], point to [Bit Switch (B)], and draw the Switch Part on the screen. Alternatively, you can click  and then draw the Switch Part.

3 Double-click the placed Switch part. The following dialog box appears.

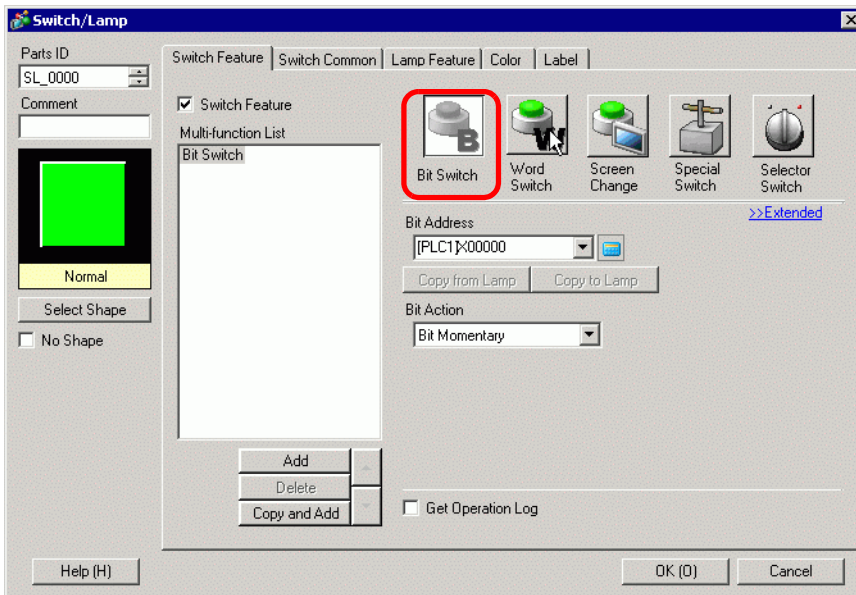

4 In [Select Shape], select the Switch shape.

5 [Designate the GP internal device LS14 Bit 2 (print start bit) in [Bit Address].

Click the icon to display an address input keypad.

Select #INTERNAL from the Device/PLC, select the "LS" device, input "1402" for the address, and then click "ENTER."

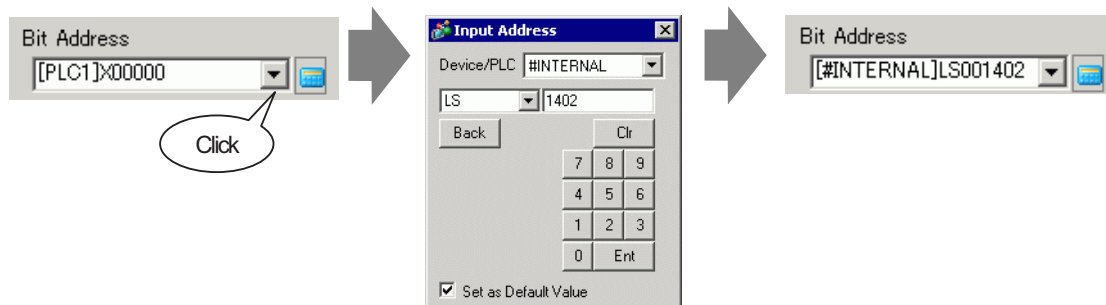

NOTE

- Alternatively, select the variable #H_Control_HardcopyPrint from the [Bit Address] pull-down menu to create the same operation switch.

6 From [Bit Action], choose [Bit Invert].



7 As needed, set the color and display text on the [Color] tab and [Label] tab, and click [OK]. A switch used to start screen print out has been created.

NOTE

- While printing the displayed screen, LS6 (status address) Bit 2 (printing bit) in the GP internal device is ON. After printing, this bit automatically turns OFF. Confirm this bit OFF and then turn OFF LS14 Bit 2(print start bit).

◆ To Trigger Printing the Current Screen from a Device/PLC

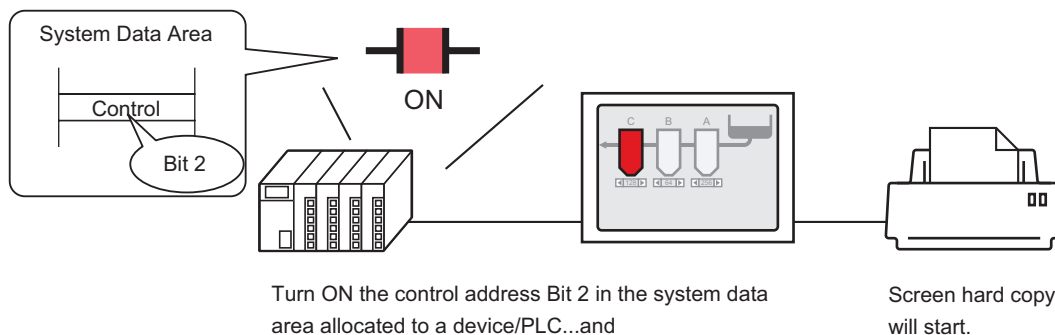

1 Configure connection settings for the printer.

☞ "34.3.2 Printer Setup Procedure" (page 34-14)

2 Click the System Settings window [Display Unit] to open the [System Area] tab.

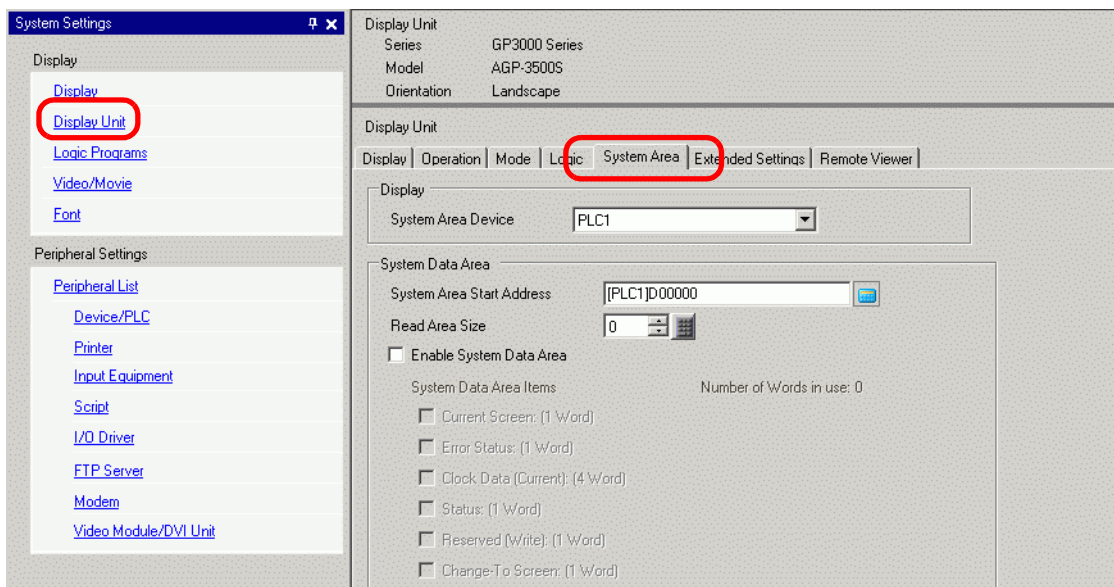

NOTE

- If the [System Settings] tab does not display in the workspace, select the [View (V)] menu, select the [Work Space (W)] option, and choose the [System Settings (S)] command.

3 Select which device/PLC to allocate the system data area in [System Area Device]. The system data area can only be set to one device/PLC.

4 Designate the start address of the system area in [System Area Start Address] and select the [Enable System Data Area] check box. (For example, D00000)

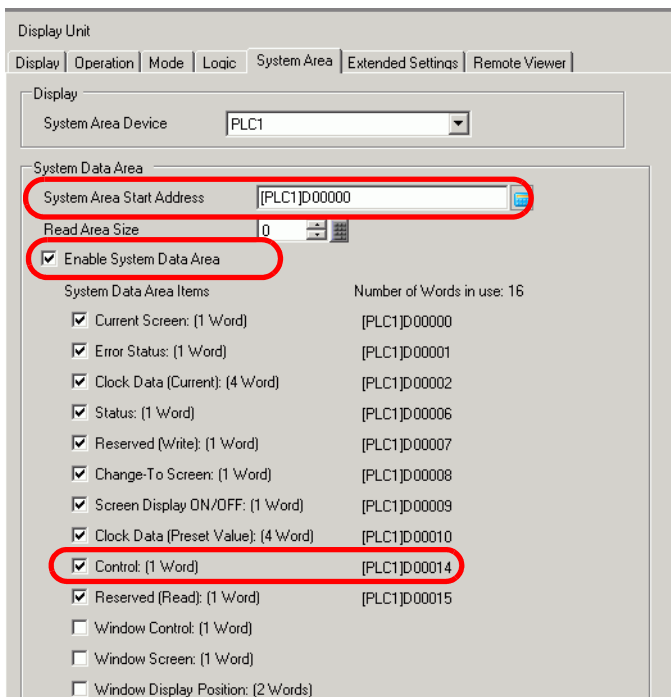

5 Select the [Control: (1 Word)] check box.

If you turn ON Bit 2 in the address that displays on the right side ('D00014' in the above example), the displayed screen will print.

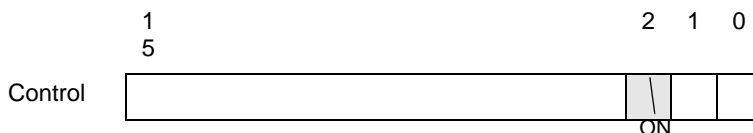

- NOTE**
- When a [Status] address ("[Status: (1 Word)] D00006" in the above example) is allocated to the device/PLC, bit 2 of this address (printing bit) is ON while printing the displayed screen. After printing, this bit automatically turns OFF. Create the [Script] to turn OFF the control address ([Control:(1 Word)] D00014) bit 2 after making sure this bit has turned OFF.

■ Memory Link Method

◆ To Trigger Printing the Current Screen by Touch

- NOTE**
- For details of the part placement method and the address, shape, color, and label setting method, refer to the "Part Editing Procedure".
 - "8.6.1 Editing Parts" (page 8-44)

Create a switch to operate the internal device address '0011' Bit 2.

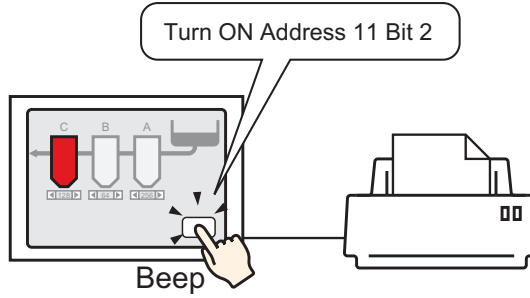

1 Configure connection settings for the printer.

☞ "34.3.2 Printer Setup Procedure" (page 34-14)

2 From the [Parts (P)] menu, select [Switch Lamp (C)], point to [Bit Switch (B)], and draw the Switch Part on the screen. Alternatively, you can click  and then draw the Switch Part.

3 Double-click the placed Switch part. The following dialog box appears.

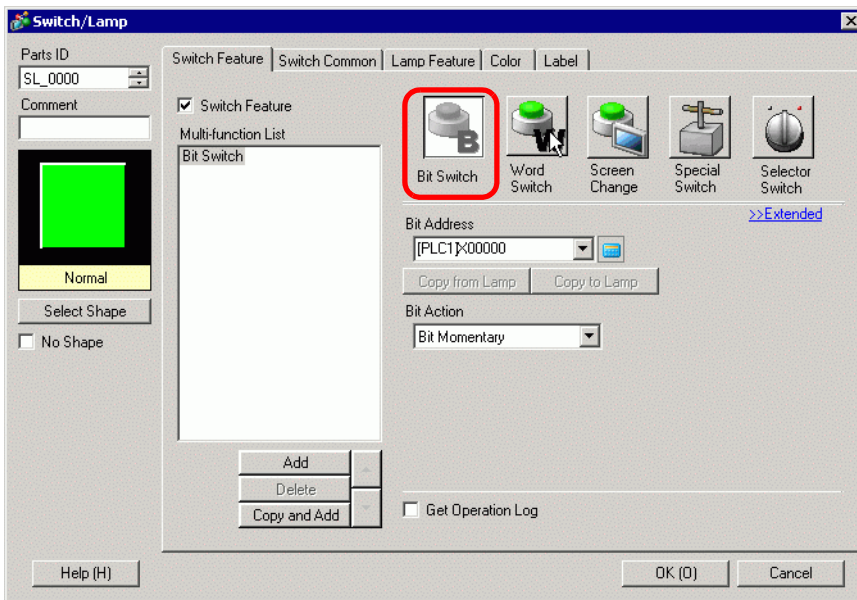

4 In [Select Shape], select the Switch shape.

5 Designate the GP internal device address '0011' Bit 2 (print start bit) in [Bit Address].

Click the icon to display an address input keypad.

Select #MEMLINK from Device/PLC, input "1102" as the address, and click the "ENTER" key.

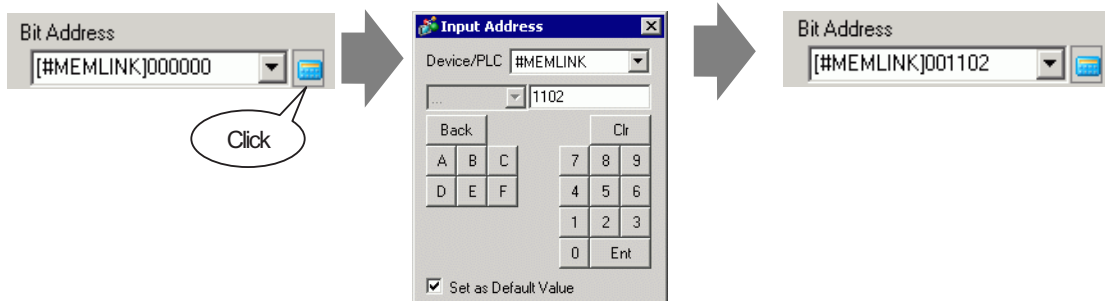

- NOTE**
- Alternatively, select the variable #H_Control_HardcopyPrint from the [Bit Address] pull-down menu to create the same operation switch.

6 From [Bit Action], choose [Bit Invert].

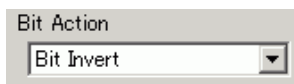

7 As needed, set the color and display text on the [Color] tab and [Label] tab, and click [OK]. A switch used to start screen print out has been created.

- NOTE**
- While printing the displayed screen, "0001" (status address) Bit 2 (printing bit) in the GP internal device (#MEMLINK) is ON. After printing, this bit automatically turns OFF. Confirm this bit OFF and then turn OFF the address "0011" Bit 2 (print start bit).

◆ To Trigger Printing the Current Screen from a PC Host

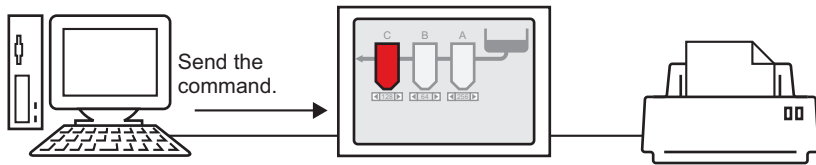

- 1 Configure connection settings for the printer.
 ☞ "34.3.2 Printer Setup Procedure" (page 34-14)
- 2 Send the write command to turn ON the internal device address "0011" Bit 2 (print start bit).
 For all inputs, use the ASCII code.

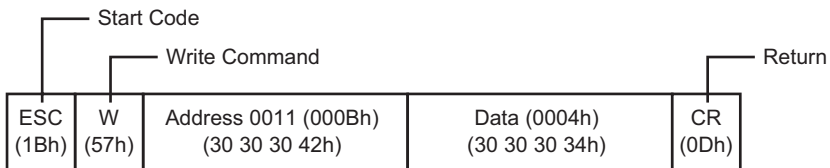

NOTE

- If you write the above commands, all bits except Bit 2 in the address "0011" will turn OFF. To turn ON only Bit 2 without changing the other bits, read out the address "0011" data with the read-out command and then send the write command to change only Bit 2 of the read-out data.
- The GP may not update the display if write commands are sent continuously.
- While printing the displayed screen, "0001" (status address) Bit 2 (printing bit) in the GP internal device (#MEMLINK) is ON. After printing, this bit automatically turns OFF. Create the [Script] to turn OFF the address "0011" Bit 2 after making sure this bit has turned OFF.

34.5 Cancel Printing

34.5.1 Introduction

You can cancel data or screen print jobs.

If you cancel, the print processes for all features that have been set will be canceled.

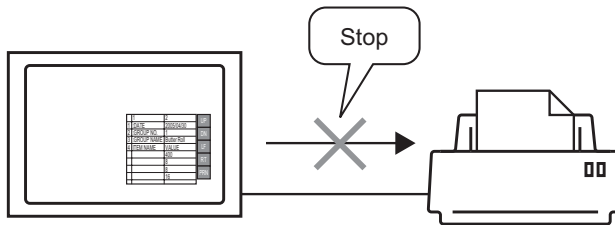

For example, 1) Canceling the (CSV data) printout.

For example, 2) Canceling the screen display printout.

ITEM NAME	VALUE
DATE	30.04.05 10:30:00
GROUP No.	10
GROUP NAME	Bread
ITEM NAME	VALUE
	150
	230
	300

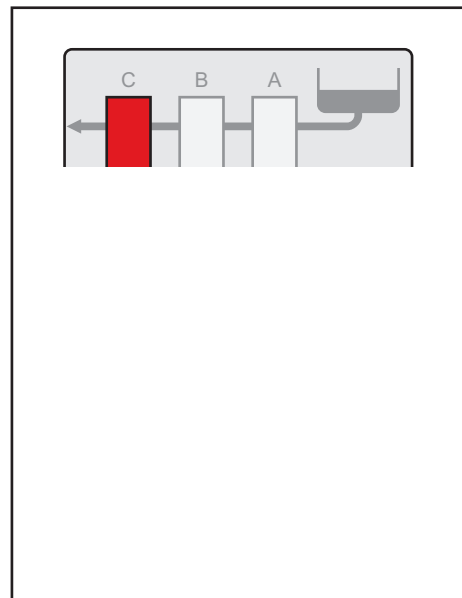
**NOTE**

- The method of canceling print differs depending on the communication method (direct access or memory link).

34.5.2 How to Cancel Printing

The following methods are used to cancel printing. The operation method differs depending on the communication method (direct access or memory link).

IMPORTANT

- For more details on the communication method, refer to:
 - ☞ "A.1.2 Communicating with a Device/PLC Using the Direct Access Method" (page A-4)
 - ☞ "A.1.3 Using the Memory Link Method with Unsupported Devices/PLCs" (page A-6)

■ Direct Access Method

Operating by Screen Touch ☞ "◆ To Cancel Printing by Touch" (page 34-40)

If you turn ON LS14 (control address) Bit 11 (print cancel bit) in the GP internal device using a switch, printing will be canceled.

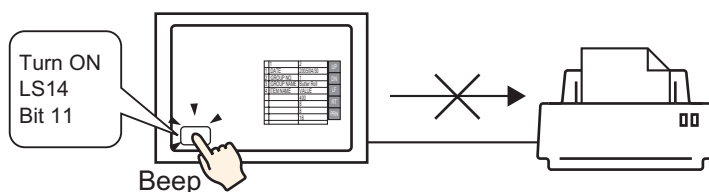

Operating from a Device/PLC ☞ "◆ To Cancel Printing from a Device/PLC" (page 34-42)

If you turn ON the [Control] address Bit 11 in the system data area allocated to a device/PLC, printing will be canceled.

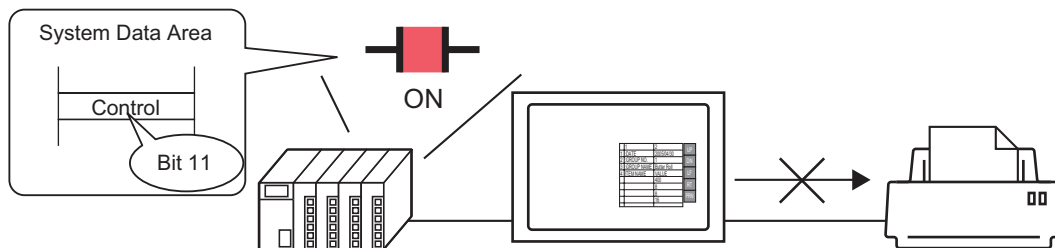

NOTE

- The internal device LS14 or the device/PLC (control address) Bit 11 does not automatically turn OFF. While Bit 11 is ON, none of the print features will operate. Be sure to turn it OFF after canceling the print.

■ Memory Link Method

Operating by Screen Touch

☞ "◆ To Cancel Printing by Touch" (page 34-43)

If you turn ON Address 11 (control address) Bit 11 (print cancel bit) in the GP internal device (#MEMLINK) using a switch, printing will be canceled.

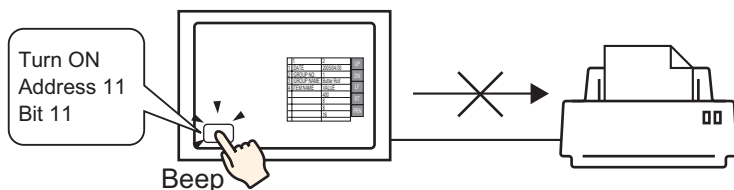

Operating from a Host (PC)

☞ "◆ To Cancel Printing from a PC Host" (page 34-46)

If you send the command to write '0800h' to Address 11 (control address) from a host (PC), printing will be canceled.

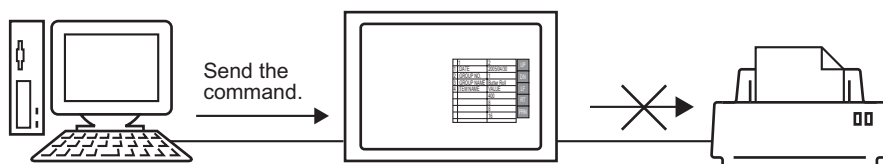

NOTE

- "0011" (control address) bit 11 in the GP internal device (#MEMLINK) does not automatically turn OFF. While Bit 11 is ON, none of the print features will operate. Be sure to turn it OFF after canceling the print.

34.5.3 Setup Procedure

■ Direct Access Method

◆ To Cancel Printing by Touch

NOTE

- For details of the part placement method and the address, shape, color, and label setting method, refer to the "Part Editing Procedure".
 "8.6.1 Editing Parts" (page 8-44)

Create a switch to turn ON the internal device LS14 Bit 11.

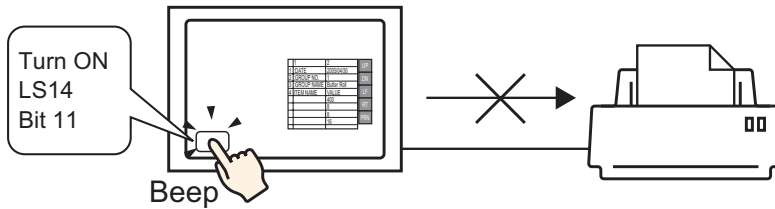

- 1 From the [Parts (P)] menu, select [Switch Lamp (C)], point to [Bit Switch (B)], and draw the Switch Part on the screen. Alternatively, you can click  and then draw the Switch Part.
- 2 Double-click the placed Switch part. The following dialog box appears.

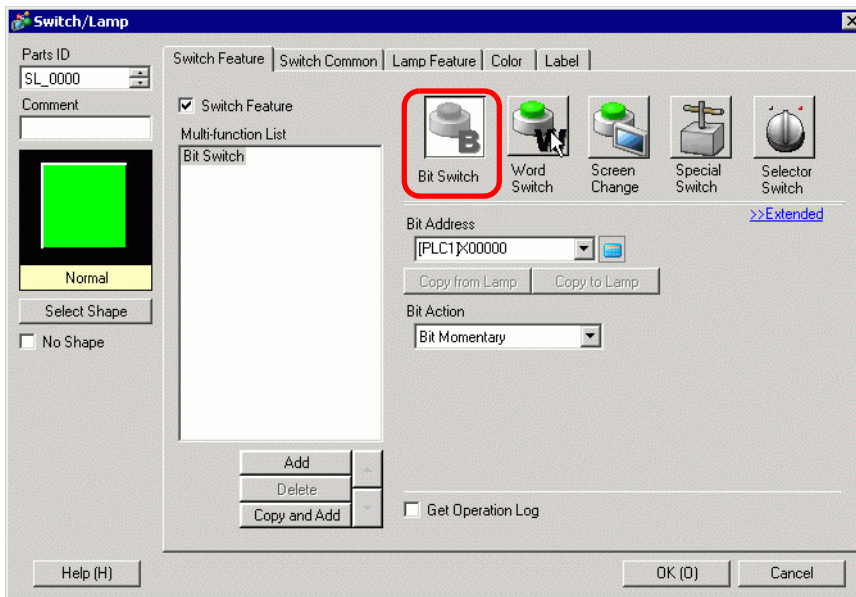

- 3 In [Select Shape], select the Switch shape.

4 Designate the GP internal device LS14 Bit 11 (print cancel bit) in [Bit Address].

Click the icon to display an address input keypad.

Select #INTERNAL from the Device/PLC, select the "LS" device, input "1411" for the address, and then click "ENTER."

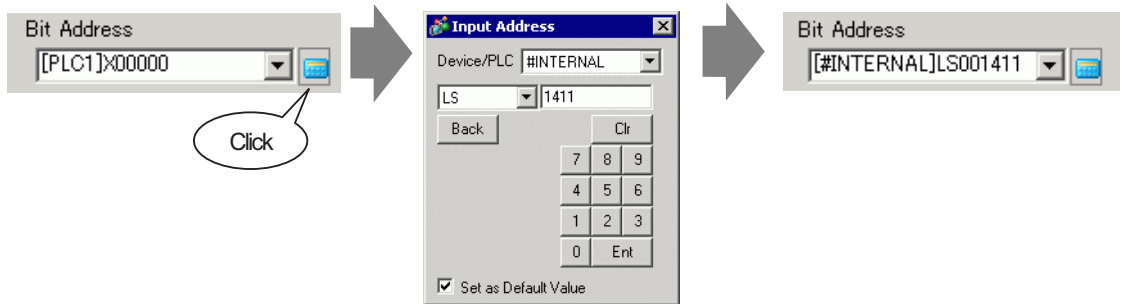

NOTE

- Alternatively, select the variable #H_Control_PrintCancel from the [Bit Address] drop-down menu to create the same operation switch.

5 Confirms that [Bit Momentary] has been selected for [Bit Action].

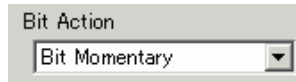

6 As needed, set the color and display text on the [Color] tab and [Label] tab, and click [OK].

A momentary switch to cancel the print has been created.

◆ To Cancel Printing from a Device/PLC

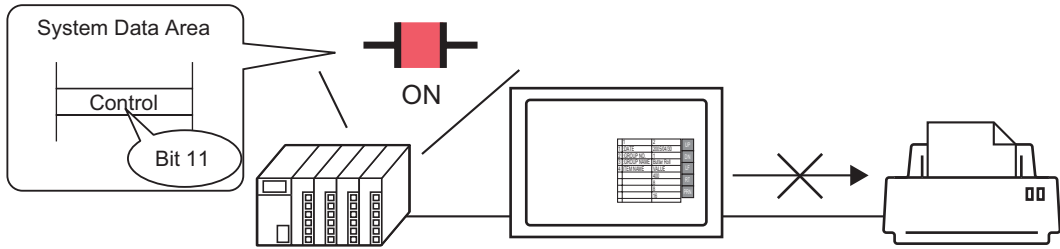

1 Click the System Settings window [Display Unit] to open the [System Area] tab.

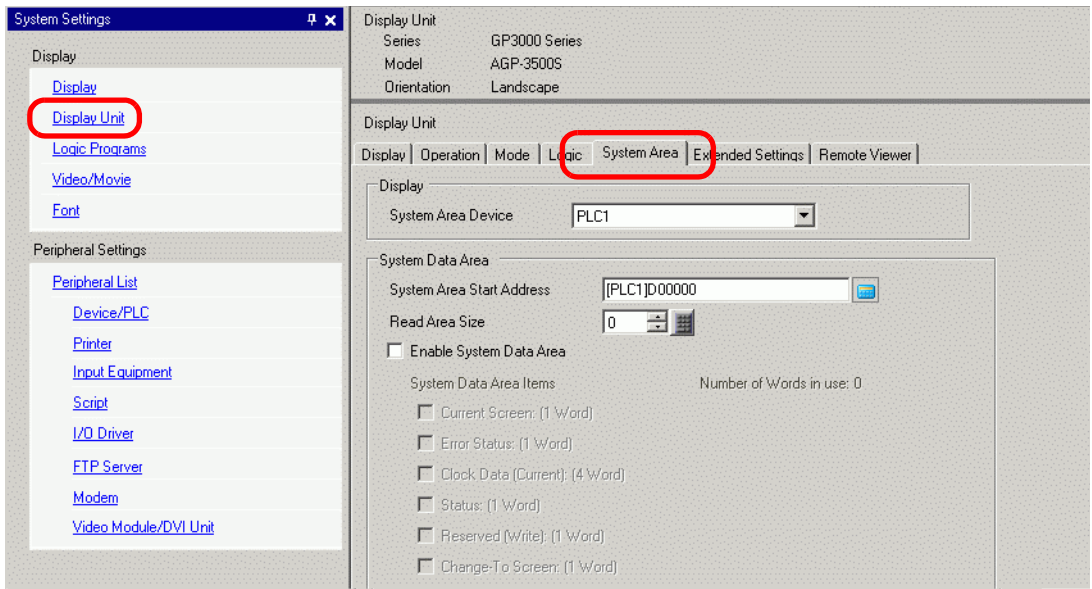

- NOTE**
- If the [System Settings] tab does not display in the workspace, select the [View (V)] menu, select the [Work Space (W)] option, and choose the [System Settings (S)] command.

2 Select which device/PLC to allocate the system data area in [System Area Device]. The system data area can only be set to one device/PLC.

3 Designate the start address of the system area in [System Area Start Address] and select the [Enable System Data Area] check box. (For example, D00000)

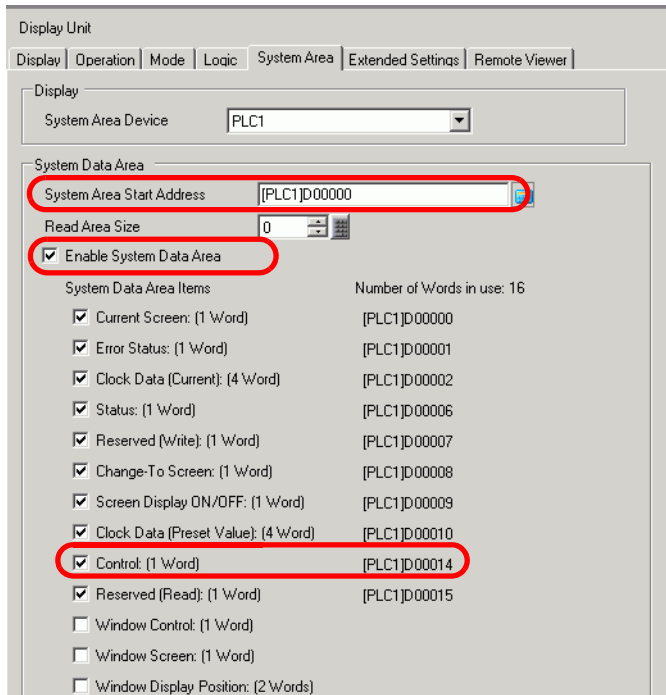

4 Select the [Control: (1 Word)] check box.

If you turn ON Bit 11 in the address that displays on the right side ('D00014' in the above example), printing will be canceled.

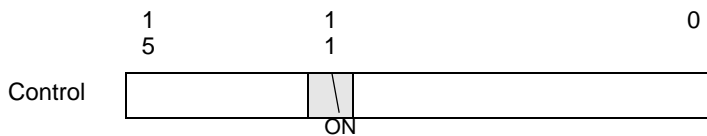

NOTE

- [Control: (1 Word)] address Bit 11 does not automatically turn OFF. While Bit 11 is ON, none of the print features will operate. Be sure to turn it OFF after canceling the print.

■ Memory Link Method

◆ To Cancel Printing by Touch

NOTE

- For details of the part placement method and the address, shape, color, and label setting method, refer to the "Part Editing Procedure".
 "8.6.1 Editing Parts" (page 8-44)

Create a switch to turn ON the internal device address '0011' Bit 11.

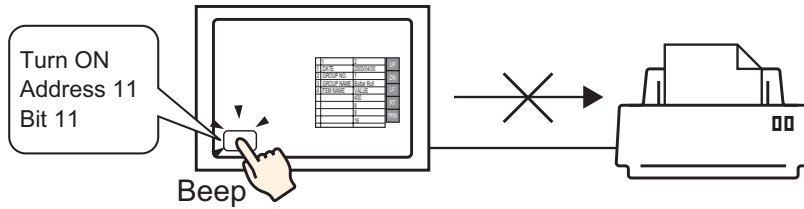

- 1 From the [Parts (P)] menu, select [Switch Lamp (C)], point to [Bit Switch (B)], and draw the Switch Part on the screen. Alternatively, you can click  and then draw the Switch Part.
- 2 Double-click the placed Switch part. The following dialog box appears.

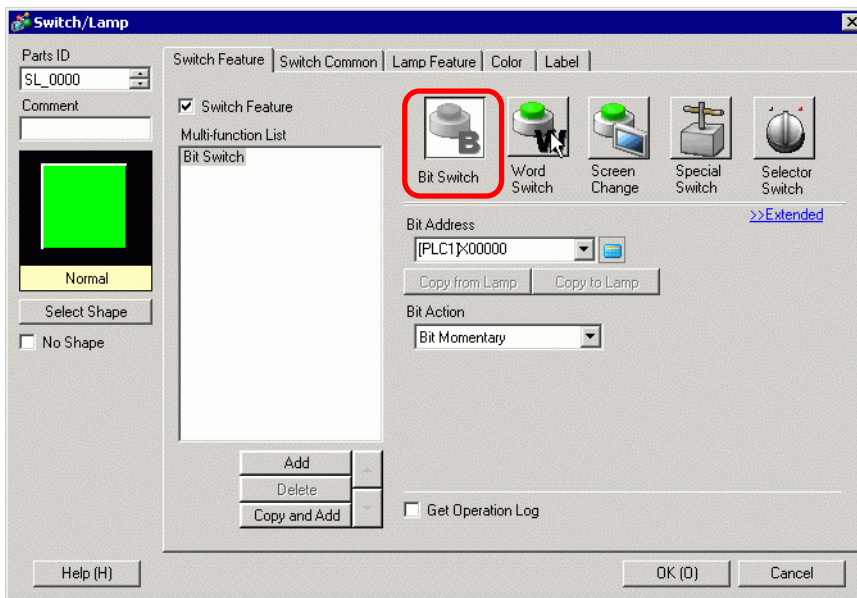

- 3 In [Select Shape], select the Switch shape.

4 Designate the GP internal device '0011' Bit 11 (print cancel bit) in [Bit Address].

Click the icon to display an address input keypad.

Select "#MEMLINK" from Device/PLC, input "1111" as the address, and click the "ENTER" key.

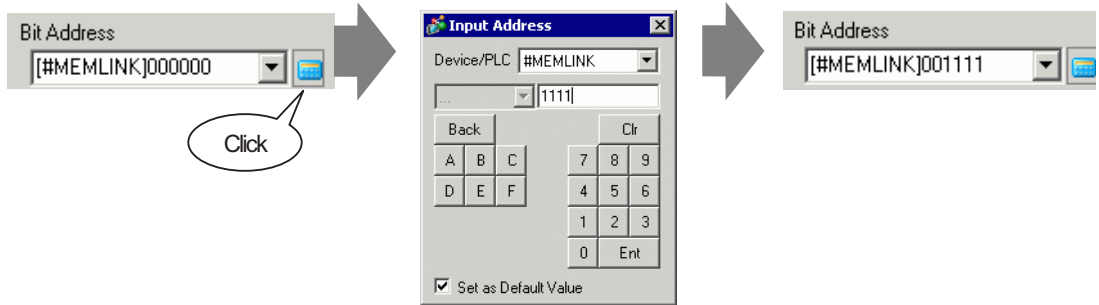

NOTE

- Alternatively, select the variable #H_Control_PrintCancel from the [Bit Address] drop-down menu to create the same operation switch.

5 Confirms that [Bit Momentary] has been selected for [Bit Action].



6 As needed, set the color and display text on the [Color] tab and [Label] tab, and click [OK].

A momentary switch to cancel the print has been created.

◆ To Cancel Printing from a PC Host

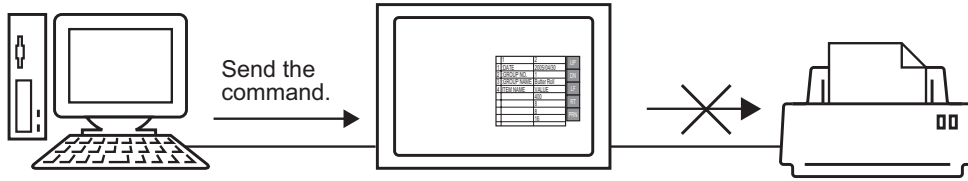

1 Send the write command to turn ON the internal device address "0011" Bit 11 (print cancel bit). For all inputs, use the ASCII code.

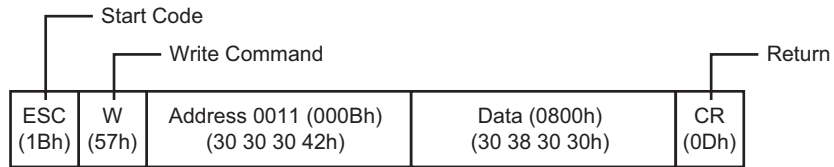

NOTE

- If you write the above commands, all bits except Bit 11 in the address "0011" will turn OFF. To turn ON only Bit 11 without changing the other bits, read out the address "0011" data with the read-out command and then send the write command to change only Bit 11 of the read-out data.
- The GP may not update the display if write commands are sent continuously.
- The address "0011" Bit 11 does not automatically turn OFF. While Bit 11 is ON, none of the print features will operate. Be sure to turn it OFF after canceling the print.

34.6 Settings Guide

34.6.1 [Print Setup] Settings Guide

Prints the settings for the currently open project file in GP-Pro EX.

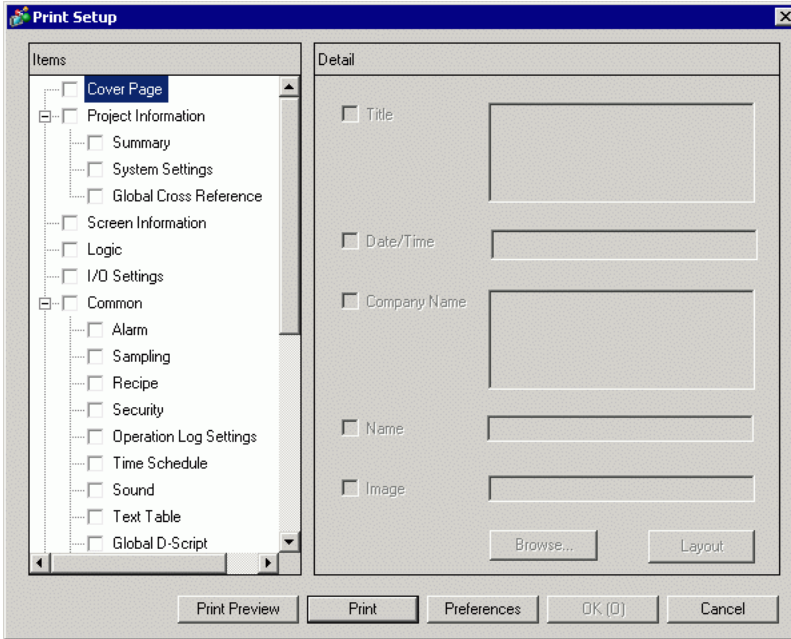

Setting	Description
Items	Select the items to print. Check the boxes for all the items you want to print in [Cover Page], [Project Information], [Screen Info], [Common] and [Comment]. [Project Information] and [Common] have sub menu items for print settings.
Detail	Detailed printing of the print contents selected in [Detail].
Cancel	The [Print Settings] dialog box closes.
OK	Saves the settings.
Preferences	The [Option Settings] dialog box appears and you can set the page number, margin, black/white reverse display and other settings. <div data-bbox="614 1379 1023 1688" data-label="Image"> </div>
Text Table used in Print	Designate the text table used for printing.

Continued

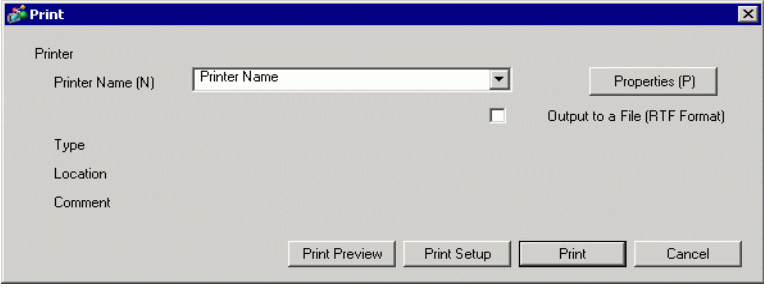
Setting		Description
Preferences	Reverse Black/White	Check the box to print the screen display colors with black and white reversed.
	Print Page Numbers	Check the box to print the page number.
	Print Number on Cover Page	Select the check box to print the page number on the cover page. Otherwise, page numbers will begin numbering from 1 after the cover page.
	Start At	Designate the number for the first page of the printout. The setting range is from 1 to 65535.
Print		<p>To set up the printer to be used and file output, etc.</p> 
	Printer Name	Select the printer to use.
	Properties	The print setting dialog box appears for the printer selected in [Printer Name]. Configure settings for the paper size, direction, layout etc.
	Output to a File (RTF format)	<p>Put a check mark here for direct output to a file (*.rtf), not to a printer. The file output is in the same layout as for printing.</p> <p>NOTE</p> <ul style="list-style-type: none"> • Reduced bitmap images are outputted.
	Cancel	Cancel printing and the dialog box closes.
	Print	Starts the print. Starts the file output when [Output to a File (RTF Format)] is designated.
	Print Setup	Display the [Print Settings] dialog box.
	Print Preview	Display the [Print Preview] screen.

Continued

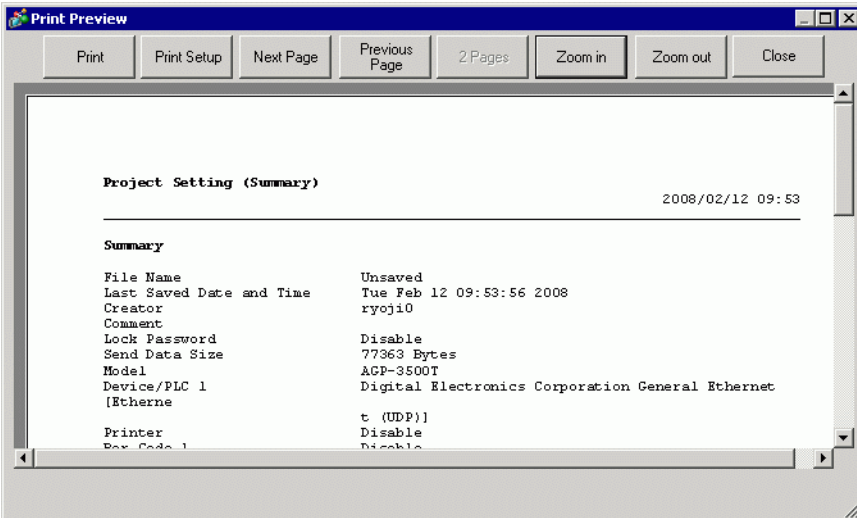
Setting	Description
Print Preview	<p>Opens the preview screen.</p>  <p>The screenshot shows a window titled "Print Preview" with a toolbar containing buttons for "Print", "Print Setup", "Next Page", "Previous Page", "2 Pages", "Zoom in", "Zoom out", and "Close". The main content area displays "Project Setting (Summary)" with a timestamp of "2008/02/12 09:53". Below this is a "Summary" section with the following details:</p> <pre> File Name Unsaved Last Saved Date and Time Tue Feb 12 09:53:56 2008 Creator ryoji0 Comment Lock Password Disable Send Data Size 77363 Bytes Model ACP-3500T Device/PLC 1 Digital Electronics Corporation General Ethernet [Etherne Printer t (UDP)) Printer Code 1 Disable Disable </pre>
Print	Displays the [Print] screen.
Print Setup	Display the [Print Settings] dialog box.
Next Page	Previews the page following the currently displayed page.
Previous Page	Previews the page preceding the currently displayed page.
2 Page	Previews 2 pages per screen.
Zoom in/Zoom out	Enlarges or reduces the display.
Close	Closes the preview screen.

■ Cover Page

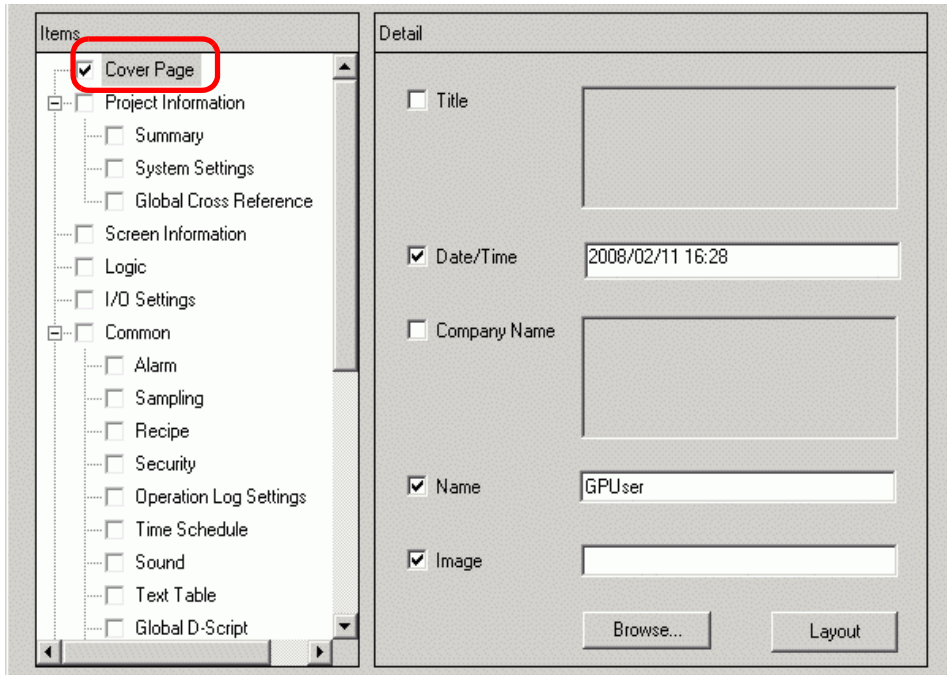

Setting	Description
Title	Select the check box to print the Title. Enter the name of the title using up to 60 single-byte or 30 double-byte characters.
Date/Time	Select the check box to print the Date/Time. The date and time displays in the "yyyy/mm/dd hh:mm" form. To change the form, enter up to 40 single-byte or 20 double-byte characters if required.
Company Name	Select the check box to print the Company Name. Then enter a name up to 60 single-byte or 30 double-byte characters.
Name	Select the check box to print the Name. The project file creator's name displays. You can change the form by entering up to 30 single-byte or double-byte characters if necessary.
Image (Display Unit)	Select the check box to print an image file on the cover page. When printing, the storage location and name of the file selected in [Browse] will display.
Browse	The [Open File] dialog box appears. Select the image file you want to print. You can use two types of files: [Bitmap (*.bmp)] and [JPEG (*.jpg, *.jpeg)].
Layout	The [Cover Page Bit Map Layout] dialog appears. You can change the layout alignment with the mouse.

■ Project Information

Select the check box beside the items you want to print: [Summary], [System Settings], and [Global Cross Reference].

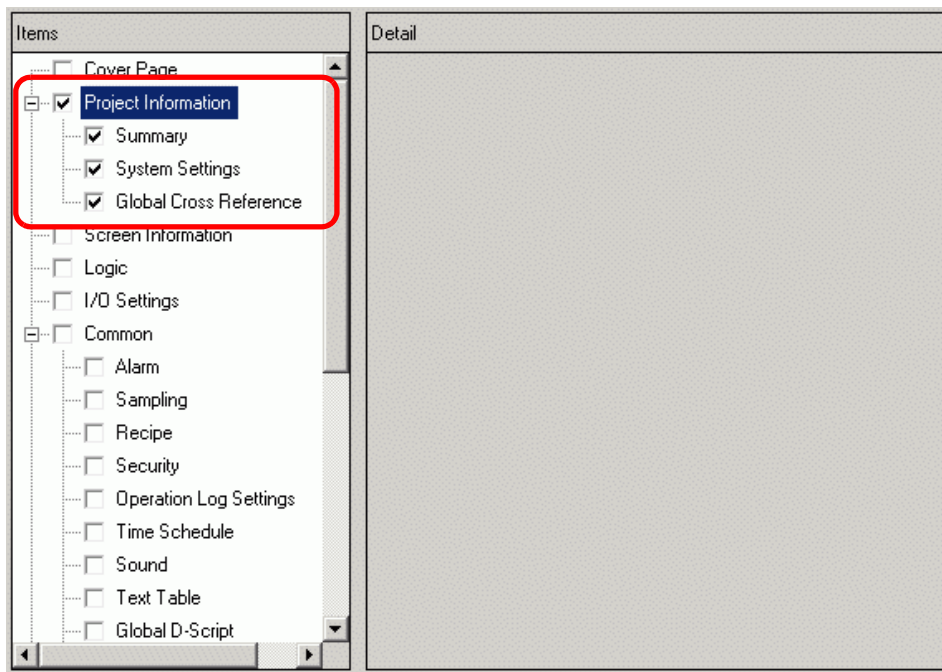

Setting	Description
Summary	Prints the project information, such as a project file name, last saved date and time, display unit model name, device/PLC, etc.
System Settings	Prints the contents of the [Display Unit] and [Font] in the [System Settings] Window.  "5.17.6 [System Settings] Setting Guide" (page 5-145)
Global Cross Reference	Prints the addressing for the whole project. The addressing for all the screens is printed.

■ Screen Information (List)

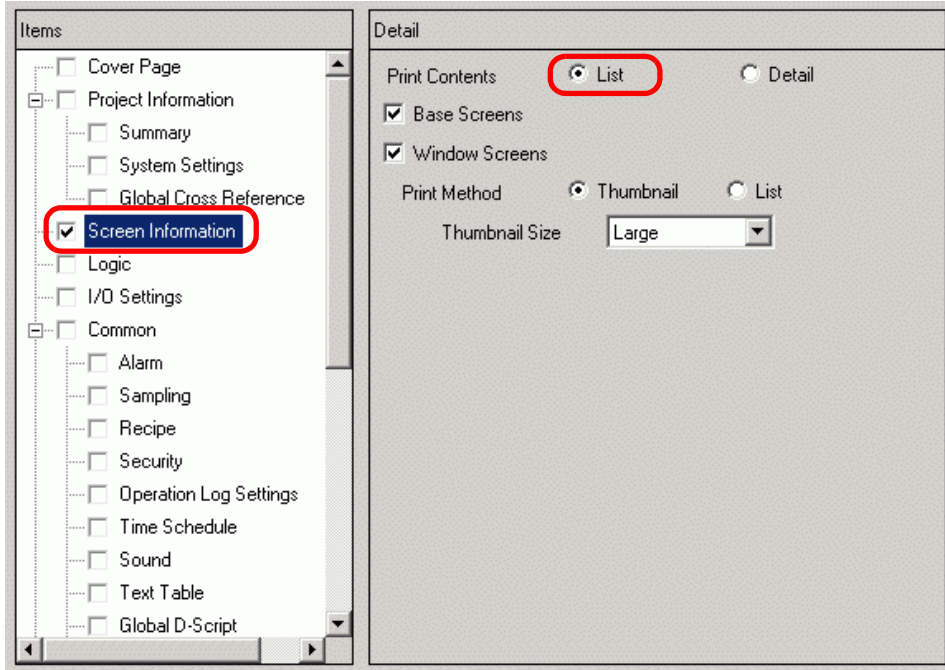

Setting	Description
Print Contents	Select the print contents from [List] or [Detail].
Base Screens	Select the check box to print all the [Base Screen] information set for the project file.
Window Screens	Select the check box to print all the [Window Screens] information set for the project file.
Print Method	Select the Print Method. <ul style="list-style-type: none"> Thumbnail Prints multiple screens in reduced images. List Prints the screen information list in text.
Thumbnail Size	For [Thumbnail] in [Print Method], select the size from [Large], [Medium] or [Small]. Large: Prints 6 reduced screen images per A4 sheet. Medium: Prints 12 reduced screen images per A4 sheet. Small: Prints 20 reduced screen images per A4 sheet.

■ Screen Information (Detail)

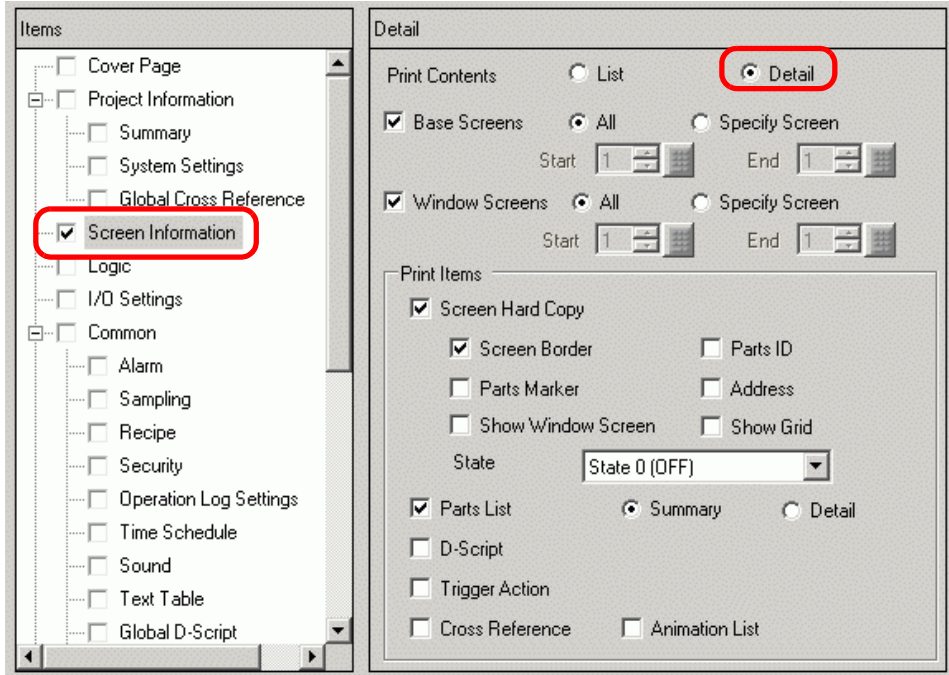

Setting	Description
Print Contents	Select the print contents from [List] or [Detail].
Base Screens	Select the check box to print the [Base Screens] information in the project file.
All/Specify Screen	To print base screen information, select [All] or [Specify Screen]. For [Specify Screen], specify the print range with screen numbers in [Start] and [End]. The setting range of screen numbers is from 1 to 9999.
Window Screens	Select the check box to print the Window Screen information in the project file.
All/Specify Screen	To print window screen information, select [All] or [Specify Screen]. For [Specify Screen], specify the print range with screen numbers in [Start] and [End]. The setting range of screen numbers is from 1 to 2000.

Continued

Setting	Description
Print Items	Select the items to print.
Screen Hard Copy	<p>Select the check box to print the drawing screen. You can then select the following check boxes:</p> 
Screen Border	Prints the Screen Border.
Parts Marker	Prints the Parts Marker.
Show Window Screen	Prints the Window Screen.
Parts ID	Prints the Parts ID.
Address	Prints the setting address.
Show Grid	Prints the grid.
State	Designate the State of the part to print.
Parts List	Prints the information list of the placed part. Select the Print Contents from [List] or [Detail].
D-Script	Prints the settings for D-Script.
Trigger Action	Prints the Triggered Action settings.
Cross Reference	Prints the addressing for the screen.

■ Logic

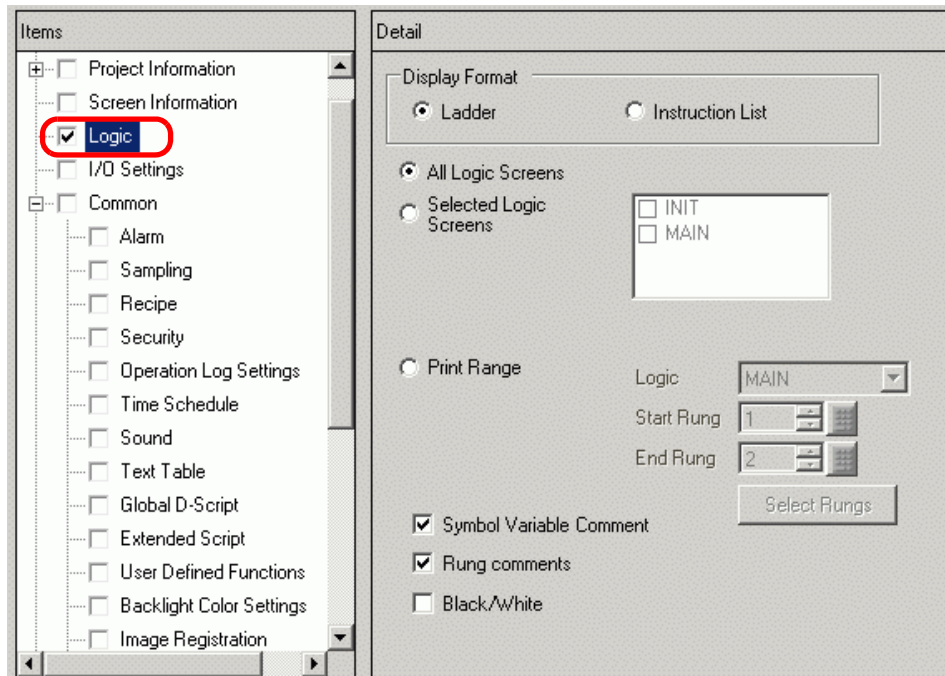

Setting	Description
Display Format	Select [Ladder] and [IL] for the display format.
All Logic Screens	Print all logic screens.
Selected Logic Screens	Select the logic screen to print from [INIT] or [MAIN]. If a subroutine program has been created, you can select from [SUB-01]-[SUB-32].
Specify Range	Specify the print range. <ul style="list-style-type: none"> • Logic Select the logic screen to print from [INIT] or [MAIN]. If a subroutine program has been created, you can select from [SUB-01]-[SUB-32]. • Start Rung Specify the row from which to start printing. • End Rung Specify the row at which to end printing. • Select Rungs In the Logic, select and click a row to specify a row number for the [Start Rung] and [End Rung].
Symbol Variable Comment	Print the comment specified for the variable.
Rung Comments	Print the comment specified for the row.
Black/White	When [Ladder] is selected for [Display Format], select whether to print Black/White.

NOTE

- If an instruction on the screen does not fit in the space between the power bars, the size of the rung will be reduced in the printout. Rungs do not wrap in the printout.

I/O Settings

NOTE

- You can only print the settings on models that support logic functions.
 ☞ "1.3 Supported Features" (page 1-5)

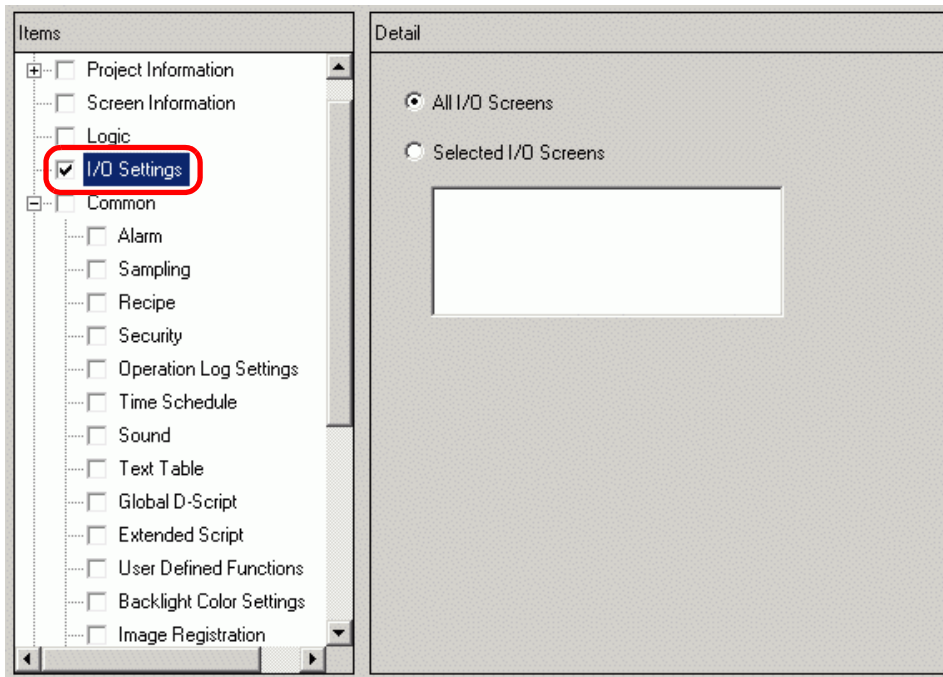

Setting	Description
All I/O Screens	Print all I/O screens.
Selected I/O Screens	Select the I/O screen to print from either [DIO Driver] or [FlexNetwork]. NOTE <ul style="list-style-type: none"> You can only print if an I/O Driver is supported.

■ **Common**

Select all the items you want to print in the [Common] settings.

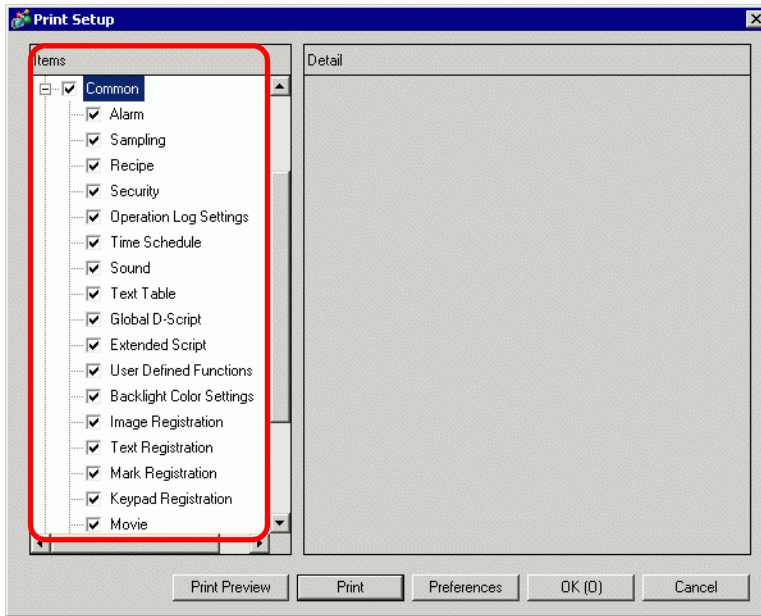

◆ **Alarm**

Check the box for all the settings you want to print from [Common], [Alarm History], [Banner], and [Summary].

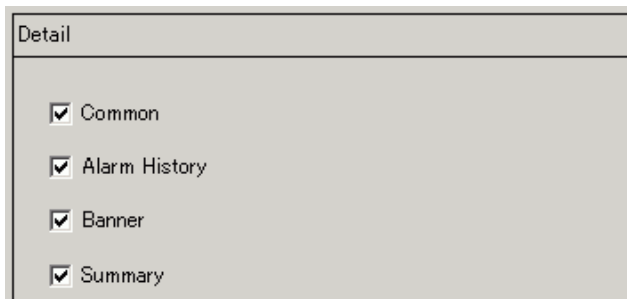

◆ **Sampling/Recipe**

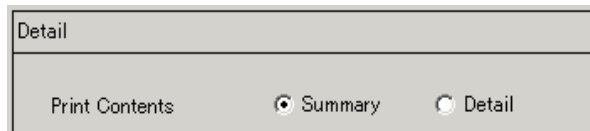

Setting	Description
Print Contents	Select the print contents from [Summary] or [Detail]. For example, For Sampling Summary: Prints a summary list of settings for each group. Detail: Prints the settings for all the items in each group.

◆ Global D-Script/User Defined Function

Setting	Description
Print Contents	Select the print contents from [List] or [Detail]. For example, For Global D-Script List: Prints a list of each [ID], [Comment], [Triggered Condition], and [Debug Function]. Detail: Prints the settings for all the items in each ID.

◆ Image Registration

Setting	Description
Print Method	Select the Print Method. <ul style="list-style-type: none"> • Thumbnail Prints multiple [Image] screens in reduced images. • List Prints a list of each [Image] screen [Number] and [Comment].
Thumbnail Size	For [Thumbnail] in [Print Method], select the size from [Large], [Medium] or [Small]. Large: Prints 6 reduced screen images per A4 sheet. Medium: Prints 12 reduced screen images per A4 sheet. Small: Prints 20 reduced screen images per A4 sheet.
Specify Range	For [Thumbnail] in [Print Method], select the Print Range from [All] or [Specify Range]. For [Specify Range], specify the Range with image numbers in [Start] and [End].

◆ Text

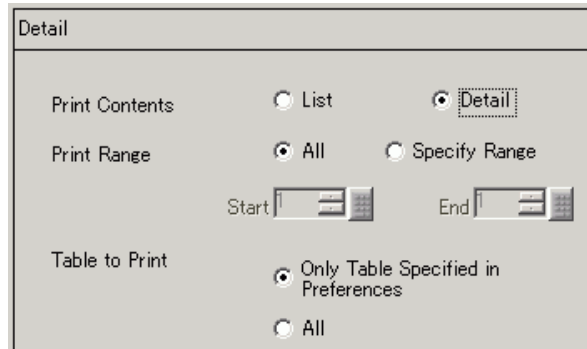

Setting	Description
Print Contents	Select the print contents from [List] or [Detail]. <ul style="list-style-type: none"> • List Prints a list of each text [Number], [Comment], [Language], [Maximum Chars], [Maximum Rows], etc. • Detail Prints the input contents of each text.
Specify Range	Select the Print Range from [All] or [Specify Range]. For [Specify Range], specify the Range with text numbers in [Start] and [End].
Table to Print	Select whether to print text with the text table specified in [Preferences] in the [Print] dialog box or with all the text tables.

◆ Mark

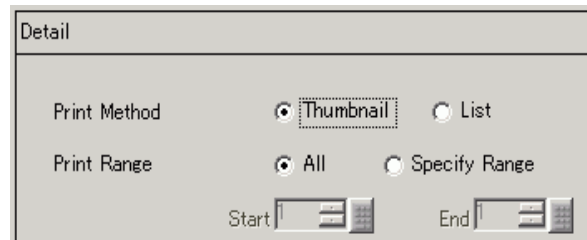

Setting	Description
Print Method	Select the Print Method. <ul style="list-style-type: none"> • Thumbnail Prints multiple [Mark] screens in reduced images. • List Prints a list of each [Mark] screen [Number] and [Comment].
Specify Range	For [Thumbnail] in [Print Method], select the Print Range from [All] or [Specify Range]. For [Specify Range], specify the Range with mark numbers in [Start] and [End].

◆ Keypad

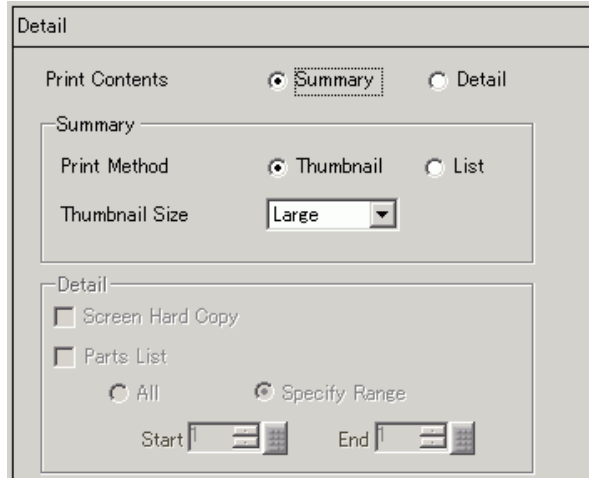

Setting		Description
Print Contents		Select the print contents from [Summary] or [Detail].
Summary	Print Method	Select the Print Method. <ul style="list-style-type: none"> • Thumbnail Prints multiple [Keypad] screens in reduced images. • List Prints a list of each [Keypad] screen [Number] and [Comment].
	Thumbnail Size	For [Thumbnail] in [Print Method], select the size from [Large], [Medium] or [Small]. Large: Prints 6 reduced screen images per A4 sheet. Medium: Prints 12 reduced screen images per A4 sheet. Small: Prints 20 reduced screen images per A4 sheet.
Detail	Screen Hard Copy	Select to print a [Keypad] screen.
	Parts List	Check the box to print a list of parts with keypad settings.
	Specify Range	For [Detail] in [Print Contents], select the Print Range from [All] or [Specify Range]. For [Specify Range], specify the Range in [Start] and [End]. NOTE • This can only be specified when the print range is 'Screen Hard Copy' or 'Parts List' or when both are set.

◆ Movie

Select the [Movie File] or [Play List] with the list you want to print.



◆ VW/DVI Unit Window

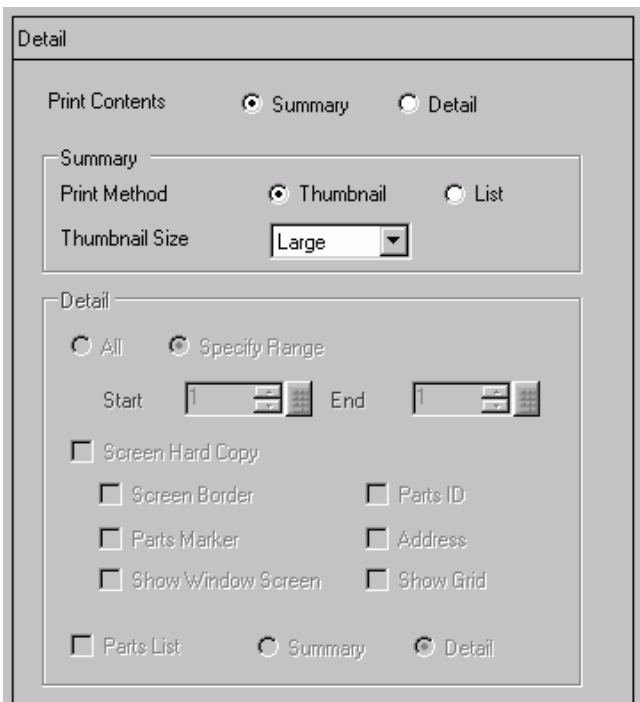

Setting		Description
Print Contents		Select the print contents from [Summary] or [Detail].
Summary	Print Method	Select the Print Method. <ul style="list-style-type: none"> • Thumbnail Print multiple [VM/DVI Unit Window] screens with a reduced size image. • List Print a list of [Numbers] and [Comments] for the [VM/DVI Unit Window] screens.
	Thumbnail Size	For [Thumbnail] in [Print Method], select the size from [Large], [Medium] or [Small]. Large: Prints 6 reduced screen images per A4 sheet. Medium: Prints 12 reduced screen images per A4 sheet. Small: Prints 20 reduced screen images per A4 sheet.
Detail	All/Specify Range	Specify whether to print all the [VM/DVI Unit Window] screens or use the [Start] and [End] fields to specify a range of screen number to print.
	Screen Hard Copy	[Screen Border], [Parts ID], [Parts Marker], [Address], [Show Window Screen], and [Show Grid] settings are displayed where you can define whether to print out a hardcopy of the screen.
	Parts List	Specify whether to print the list of parts specified in the VM/DVI unit window in [Summary] or [Details].

◆ **Global Function Setting**

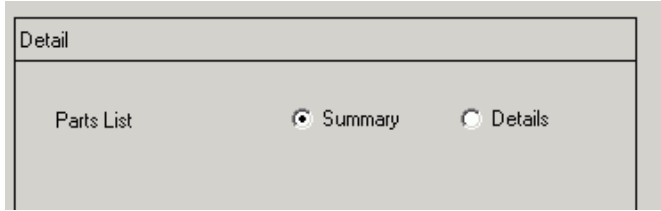

Setting	Description
Parts List	Specify whether to print the list of parts specified in the global function in [Summary] or [Details].

◆ **Comments List**

Specify all the [Symbol], [Variable], [System Variables], and [Rung] that you wish to print.

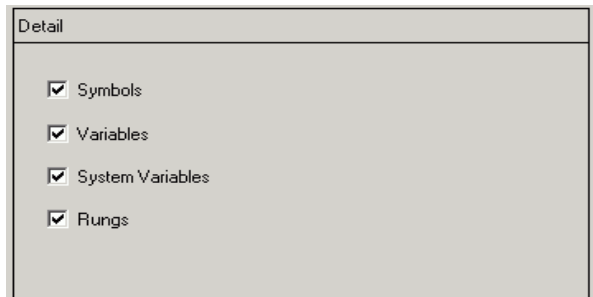

■ **Comment**

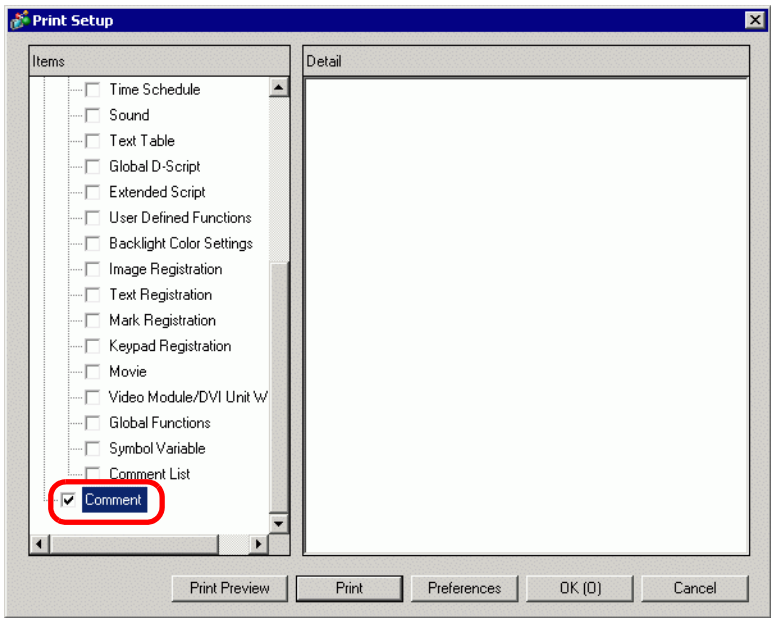

Enter a comment for the print contents. The comment can be up to 80 single-byte characters (40 double-byte characters) x 40 rows.

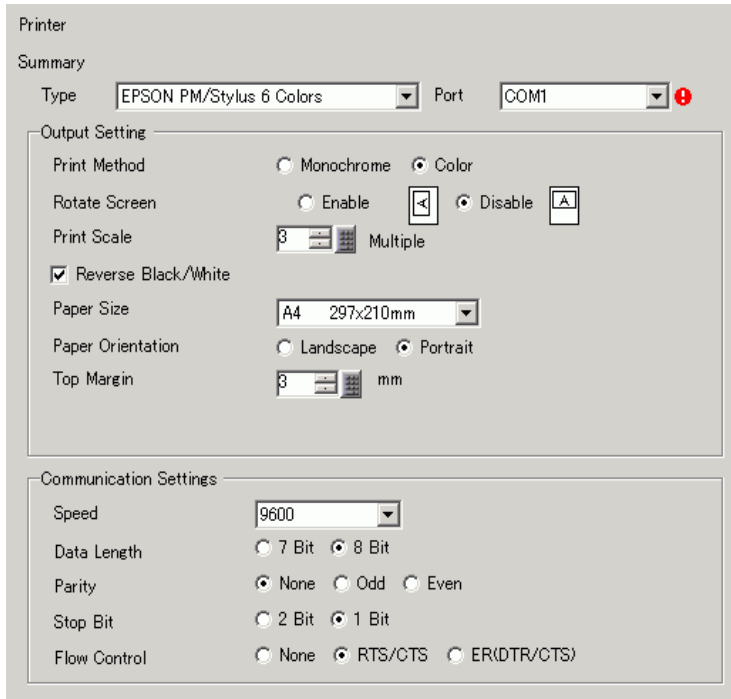

34.6.2 System Settings [Printer] Settings Guide

Set up and connect a printer to the display.



Setting	Description
Type	<p>Select the printer type to connect to from one of the following: [Do Not Use], [NEC PR201], [EPSON ESC/P High Speed], [EPSON ESC/P High Quality], [HP Laser Jet], [EPSON PM/Stylus 6 Colors], [EPSON PM/Stylus 4 Colors], GP Remote Printer Server], [Text ASCII].</p> <p>NOTE</p> <ul style="list-style-type: none"> • For [Text ASCII], the text's shape may be different because the print method is different. • A different screen displays when [GP Remote Printer Server] is selected.  " GP Remote Printer Server Settings" (page 34-65)
Port	<p>Select the output port of the printer to connect from [COM1], [Ethernet], [USB], or [USB/PIO].</p> <p>NOTE</p> <ul style="list-style-type: none"> • If the port is already used by another device, the  mark displays next to the box.

Continued

Setting		Description
Output Setting	Print Method	<p>Select the print method from [Monochrome] or [Color].</p> <p>NOTE</p> <ul style="list-style-type: none"> For a monochrome display model, the output will be monochrome even if [Color] is selected for the [Print Method]. Normally, these settings are only applied to Screen Hard Copy. When HP Laser Jet printer prints the alarm history, however, this setting is applied. For example, if you select [Color] for HP Laser Jet color printer model, it prints in color. If you select [Color] for a monochrome model, it cannot print properly.
	Rotate Screen	Select the direction for printing the screen.
	Print Scale	Set the print scale to 1-4 only if the [Type] is [EPSON PM/Stylus 6 Colors] or [EPSON PM/Stylus 4 Colors].
	Reverse Black/White	Select whether or not to print the background in black or white.
	Connection Method	Select the LAN printer connection method from [LPR] or [IPP] only if the [Port] is [Ethernet].
	Paper Size	Select the paper size from [A3], [A4], [B4], [B5], or [Letter] only if the [Type] is [EPSON PM/Stylus 6 Colors] or [EPSON Stylus 4 Colors].
	Paper Orientation	Select the output paper orientation from [Landscape] or [Portrait] only if the [Type] is [EPSON PM/Stylus 6 Colors] or [EPSON Stylus 4 Colors].
	Top Margin	<p>Specify the top margin from 3-20 only if the [Type] is [EPSON PM/Stylus 6 Colors] or [EPSON PM/Stylus 4 Colors].</p> <p>NOTE</p> <ul style="list-style-type: none"> When you use PM-G700, PM-G720, or PM-G730, please specify 3mm for the top margin. If you set up more than 3mm, screen hardcopies will print correctly but nothing else will.

GP Remote Printer Server Settings

Setting		Description
Output Setting	Paper Size	Select the print paper size: [A3], [A4], [Letter] and [Legal].
	Orientation	Select either [Landscape] or [Portrait] for the printing orientation.
	Print Size	Select either [Original Size] or [Fit to Printer Margins] for the printing size of print screen. When printing text, this setting is ignored. NOTE <ul style="list-style-type: none"> When using [Original Size], print output outside the print area is not printed. When [Fit to Printer Margins] is selected, the image will not be corrected in zoom in and out processes. Aspect ratio will also not be changed.
	Margin	Specify the top, bottom, left, and right margins from 5 to 50mm.

Continued

Setting		Description
Communication Settings	IP Address	Configure the print server IP address.
	PASV	Specify whether to use PASV mode. This option is typically used when the connection is blocked by network security.
	Port	Specify the IIS FTP server port number.
	User Name	Define the login user name for the FTP server. You can use up to 16 single-byte alphanumeric characters for the password.
	Password	Define the login password for the FTP server. You can use up to 16 single-byte alphanumeric characters for the password.

Communication Settings (for COM1)

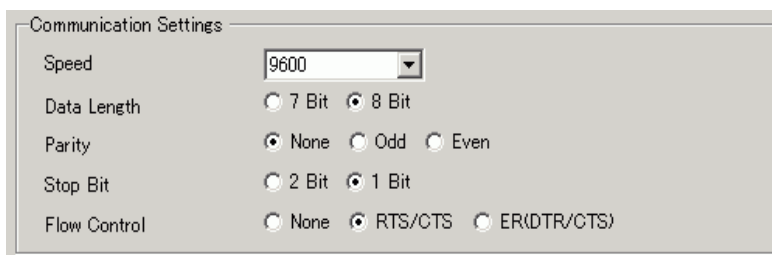

Setting	Description
Communication Speed	Select a communication speed to the printer from [2400], [4800], [9600], [19200], [38400], [57600] or [115200].
Data Length	Choose the communication data length to the printer from [7 Bit] or [8 Bit].
Parity	Select the communication parity bit to the printer from [None], [Odd], or [Even].
Stop Bit	Choose the communication stop bit length to the printer from [2 Bit] or [1 Bit].
Flow Control	Select the communication control method to the printer from [None], [RTS/CTS Control], or [ER (DTR/CTS) Control].

NOTE

- Confirm all settings are compatible with the selected printer.

Communication Settings (for Ethernet)

Communication Settings

IP Address: 0 . 0 . 0 . 0

Port: 1024

Timeout: 90

User Name: noname

Printer Name: noname

Setting	Description
IP Address	Configure the print server IP address.
Port	Configure the print server port number from 0 to 65535.
Time out	Set the output time out from 0 to 300 milliseconds.
User Name	Enter the name of the user who requests a printing job only if the [Connection Method] is [LPR]. The name specified here displays in the owner field on the queue display. (For example, "Guest")
Printer Name	Set the shared name of the printer server only if the [Connection Method] is [LPR]. (For example, "EPSONStyC61")
Printer URI	This item displays only if the [Connection Method] is [IPP]. Set part of the printer's network name. (For example, "/printers/StyC61/.printer")

NOTE

- When printing with LAN connection, there may be a short delay before the print starts.

34.7 Restrictions

34.7.1 Restrictions for Printing from the GP

- Only one printer can be connected to the GP.
- The print is canceled if you switch to the offline screen or transfer screens during printing.
- Portions exceeding the paper width will not be printed or automatically line-fed. Data that does not fit onto the printed area of a page is handled differently by various printers.

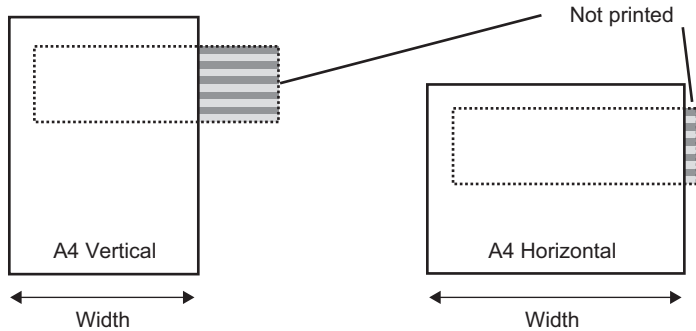

- For Screen print out on a display with a screen size larger than SVGA, see below as to whether the data fits the paper. (VGA and QVGA fit both A4 and A3 papers.)

NEC PR201, EPSON ESC/P (High Speed), EPSON ESC/P (High Quality), HP LaserJet

Screen Size	Rotate Screen	Paper Size	
		A4	A3
SVGA	Enable	O	O
	Disable	X	O
XGA	Enable	X	O
	Disable	X	X

Enable: Fits the paper, Disable: Does not fit the paper

EPSON PM/Stylus 6 Colors, EPSON PM/4 Colors

Screen Size	Rotate Screen	Paper Size							
		A4				A3			
		Magnification ratio				Magnification ratio			
		x 1	x 2	x 3	x 4	x 1	x 2	x 3	x 4
SVGA	Enable	O	O	O	O	O	O	O	O
	Disable	O	O	O	X	O	O	O	O
XGA	Enable	O	O	O	X	O	O	O	O
	Disable	O	O	X	X	O	O	O	X

Enable: Fits the paper, Disable: Does not fit the paper

- GP screen updates (parts and screen switching processing) will become slower when printing large amounts of data, especially when printing on EPSON PM/Stylus (6 Colors) or Stylus (4 colors),

- When printing the displayed screen in monochrome tone, the print results vary between PM/Stylus (6 Colors) or Stylus (4 Colors) and with other printers (such as NEC PC-PR201). This is because the color data is identified not by its density but by levels of shading.
- If the printer type is [Text ASCII], the text shape may be different because the print method is different.
- If you cancel, all the print processing features that have been set will cancel.
- When the communication method is direct access, use the system data area (the area that links to the system data area in the GP internal device) to control printing of the displayed screen or print canceling from a device/PLC. If multiple devices/PLCs are connected, the system data area can be set to only one device/PLC.
- If the communication method is Memory Link and write commands are sent continuously without pause, GP may not update its display.
- When printing with LAN connection, there may be a short delay before the print starts.
- If you print from the GP when the printer is not connected to it with a cable or when the printer is OFF, the GP temporarily saves the print data. When the connection with the printer recovers or when the printer turns ON, the GP outputs the temporarily saved print data to the printer.
- LAN connection (network printer) does not support Alarm (Banner) Print, Alarm (History) Real-time Print, Alarm (History) Batch Print, Sampled Data Real-time Print, Sampled Data Batch, CSV Data Print, or Script Printer Output.
- For monochrome GPs, in the [System Settings] [Printer] area, even if the [Print Method] is set to [Color], the print output will be monochrome.
- Regardless of whether [Printer] - [Print Method] is set with monochrome or color settings, an Alarm History is printed out in color. However, if the printer [Type] is set to HP Laser Jet, and for the [Print Method], you selected [Monochrome], Alarm History is also printed in monochrome.
- Some printers used cannot print Alarm History and Sampling per line in real-time printing. This is because the printers don't support paper feed per line.

34.7.2 Restrictions of GP Remote Printer Server

- Once you set up a GP Remote Printer Server for your display unit, you cannot change to a unit that does not support the GP Remote Printer Server. A warning message displays and the unit will not change if you attempt to do so.
- Even when printing a hard copy during screen capture, an error occurs and printing is not executed.
- When [GP Remote Printer Server] is set for printer settings, setting changes in the display cannot be made offline. When other drivers are set, the display unit cannot be changed to [GP Remote Printer Server] offline.
- Only English and Japanese languages are supported for the following features: Alarm (Banner) Print, Alarm (History) Real-time Print, Alarm (History) Batch Print, Sampled Data Real-time Print, Sampled Data Batch, and CSV Data Print. Any language other than Japanese and English will not print correctly.
- If a computer does not have a Japanese OS, Japanese text will not print correctly.

- Set the printer directly connected to the computer in which GP Remote Printer Server is installed as the "default printer". To use and share a printer connected to another computer on the network, please consult the network administrator, because it depends on the environment.