

20



Animating Screen Objects

This chapter explains the basic operations of "Animation" in GP-Pro EX.
Please start by reading "20.2 Settings Menu" (page 20-7), and then turn to the corresponding page.

| | | |
|------|--|-------|
| 20.1 | Animation - General | 20-2 |
| 20.2 | Settings Menu | 20-7 |
| 20.3 | Showing and Hiding Objects | 20-8 |
| 20.4 | Moving Objects to show Changes in Condition..... | 20-11 |
| 20.5 | Rotating Objects to show Changes in Condition..... | 20-16 |
| 20.6 | Changing Object Colors based on Address Values | 20-19 |
| 20.7 | Settings Guide..... | 20-22 |
| 20.8 | Restrictions | 20-51 |

20.1 Animation - General

20.1.1 About Animation

Animation is a feature that enables you to temporarily hide or change the colors and positions of parts and drawings (objects). This feature allows you to highlight specific objects, enhance security, and create movement on the screen.

You can set up the following animation with GP-Pro EX.

NOTE

- The following section lists models compatible with animation.
 "1.3 Supported Features" (page 1-5)

■ Show/Hide Objects

You can hide screen drawings and make them appear, as needed. You can use this as a security feature to hide objects that only specific users can operate.

For example:

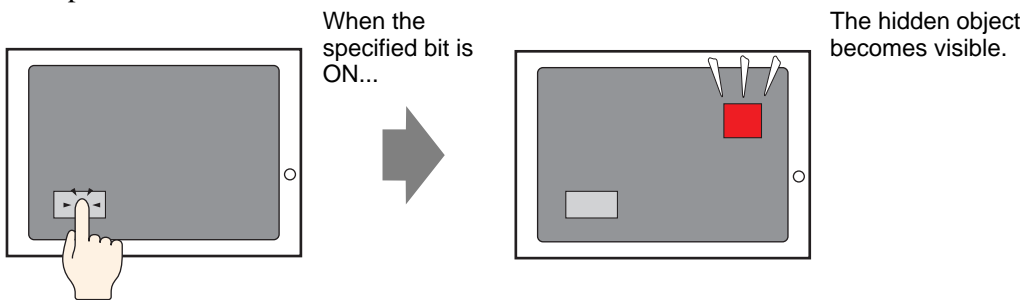

■ Change Position of Drawings

You can move screen drawings to reflect changes in the condition of the site.

For example:

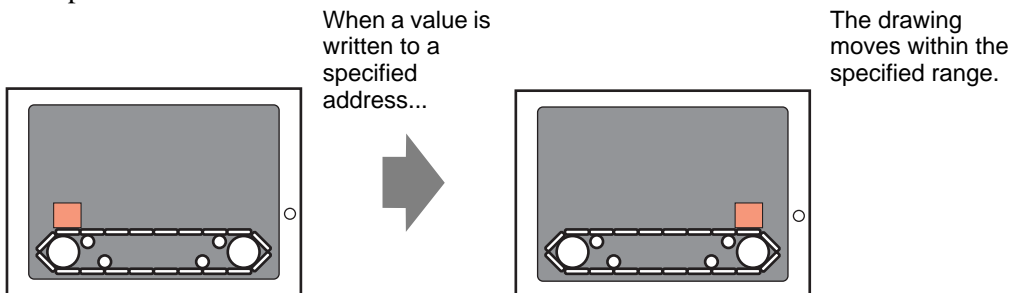

■ Rotate an Object

By rotating objects, you can show the rotation of equipment such as a fan or motor, as well as the movement of a needle in a meter, to follow actual changes in value.

For example:

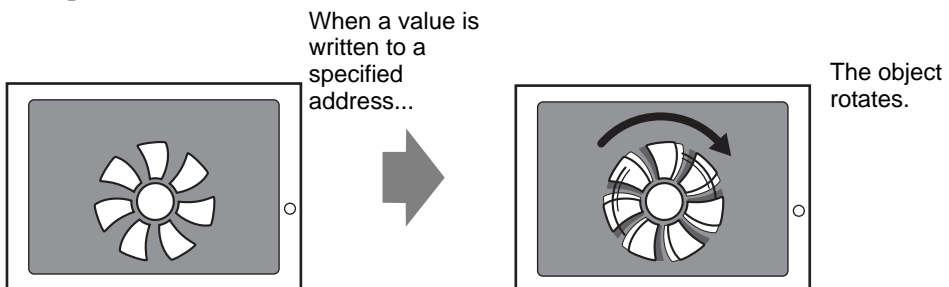

■ Change Object Colors

You can change object colors at defined times. This is useful when, for example, you want to highlight the display by changing its color when it exceeds a certain value.

For example:

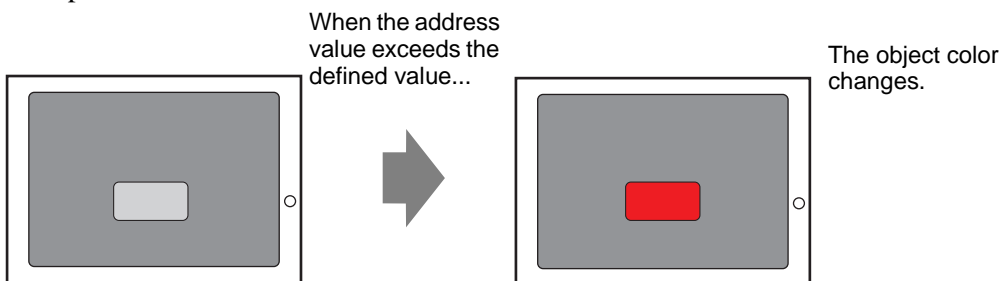
**NOTE**

- When working with images, you can select one of the colors in the image and change its hue. For details on how to set this up, see the following.
☞ "20.7.1 [Animation Settings] Settings Guide ◆ Hue Animation" (page 20-31)

20.1.2 Supported Objects

| | Draw | Visibility | Color | Position | Rotation | Hue |
|-------|---------------------------------|------------|-------|----------|----------|-----|
| Draw | Text | O | O | O | X | X |
| | Dot | O | O | O | O | X |
| | Line/Polyline | O | O | O | O | X |
| | Rectangle | O | O | O | O | X |
| | Polygon | O | O | O | O | X |
| | Circle/Oval | O | O | O | O | X |
| | Arc | O | O | O | O | X |
| | Pie | O | O | O | O | X |
| | Scale (Bar) | O | O | O | O | X |
| | Scale (Arc) | O | O | O | O | X |
| | Image Placement | O | X | O | O | O |
| | Call Screen (Base Screen) | X | X | X | X | X |
| | Call Screen (Image) | X | X | X | X | X |
| | Call Screen (Image on CF card) | X | X | X | X | X |
| | Call Screen (Mark) | X | X | X | X | X |
| | Call Screen (Keypad) | X | X | X | X | X |
| | Table | O | O | O | X | X |
| | Background Color | X | X | X | X | X |
| | Group | O | O | O | O | X |
| Parts | Switch and Lamp | O | X | X | X | X |
| | Data Display ^{*1} | O | X | X | X | X |
| | Keypad | O | X | X | X | X |
| | Key | O | X | X | X | X |
| | Graph | O | X | X | X | X |
| | Historical Trend Graph | X | X | X | X | X |
| | Data Block Display Graph | X | X | X | X | X |
| | Alarm | O | X | X | X | X |
| | Text Alarm | X | X | X | X | X |
| | Message Display | O | X | X | X | X |
| | Window | X | X | X | X | X |
| | Movie Player | X | X | X | X | X |
| | Video Module/DVI Display | X | X | X | X | X |
| | Remote PC Access Window Display | X | X | X | X | X |
| | Picture Display | X | X | X | X | X |
| | Sampling Data Display | X | X | X | X | X |

Continued

| | Draw | Visibility | Color | Position | Rotation | Hue |
|-----------------|--|------------|-------|----------|----------|-----|
| Parts | Special Data Display (Data Transmission) | X | X | X | X | X |
| | Special Data Display (Filing) | X | X | X | X | X |
| | Special Data Display (Show CSV) | X | X | X | X | X |
| | Special Data Display (File Manager) | X | X | X | X | X |
| | Trigger Action (Draw Action) | X | X | X | X | X |
| | XY Historical Scatter Graph | X | X | X | X | X |
| | XY Block Display Scatter Graph | X | X | X | X | X |
| | Selector List | O | X | X | X | X |
| | Bulletin Message | O | X | X | X | X |
| | D-Script | X | X | X | X | X |
| | Selector List Switch | O | X | X | X | X |
| | Operation Lock | O | X | X | X | X |
| | Security | O | X | X | X | X |
| | Transfer Device/PLC Data | O | X | X | X | X |
| Common Settings | Banner Alarm | X | X | X | X | X |

*1 The Input Display, a type of Data Display, does not support animation.

NOTE

- When objects are grouped, you can add animation only if every object in the group supports that animation. See the following for operations when animation is added to grouped parts.
 "20.1.3 Animation on Grouped Objects" (page 20-6)
- Animation does not work with graphics loaded in a Picture Display.

■ Color Animation Supported by Drawings

| Draw | Supported Color Animation |
|--|------------------------------------|
| Rectangle, Polygon, Pie, Circle/ Oval | Foreground/Background, Line/Border |
| Table | Foreground/Background, Line/Border |
| Dot | Foreground |
| Line, Polyline, Arc, Scale | Line/Border |
| Text | Background, Text |

20.1.3 Animation on Grouped Objects

When animation is added to grouped parts, the relationship between the group animation and an individual part's animation is as follows.

NOTE

- See the following for information on grouping objects.
☞ "8.4.7 Grouping (Ungrouping)" (page 8-31)
-

■ Visibility Animation

Animation on the group takes priority.

When the grouped object is displayed, you can hide any object in the group.

■ Color Animation

Animation on the object takes priority.



■ Position Animation

- Position Animation is added to the group and object
Animation added to the group runs first, and then the animation added to the object is run.
- Position Animation is added to the group and Rotation is added to an object
Position Animation for the group is run. As a result, the Rotation's [Rotation Center] coordinates set up on objects will move. Rotation of objects run after movement is complete.

■ Rotation Animation

- When Rotation is added to the group, the [Rotation Center] coordinate is set up for the entire group. The [Rotation Center] coordinate for each object is also maintained.
- Rotation is added to the group and object
Animation added to the group runs first. As a result, the Rotation's [Rotation Center] coordinates set up on objects will move. Rotation of objects run after movement is complete.
The [Rotation Center] coordinates are different between the group and object.
- Rotation is added to the group and Position Animation is added to an object
Rotation for the group is run. As a result, the object's X/Y coordinates used for Position Animation movement will rotate. Position Animation on the object runs after rotation is complete.

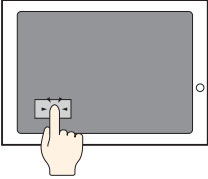
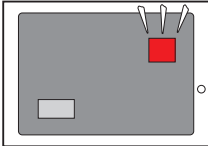
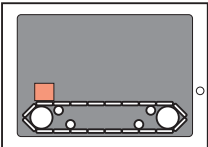
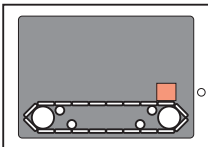
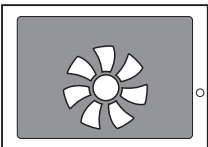
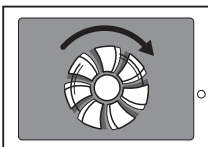
20.2 Settings Menu

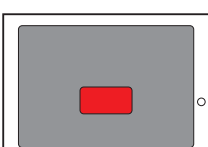
| Showing and Hiding Objects | | |
|---|--|---|
|  <p>When the specified bit is ON...</p> |  <p>The hidden object becomes visible.</p> | <ul style="list-style-type: none"> ☞ Setup Procedure (page 20-8) ☞ Introduction (page 20-8) |
| Moving Objects to show Changes in Condition | | |
|  <p>When a value is written to a specified address...</p> |  <p>The drawing moves within the specified range.</p> | <ul style="list-style-type: none"> ☞ Setup Procedure (page 20-11) ☞ Introduction (page 20-11) |
| Rotating Objects to show Changes in Condition | | |
|  <p>When a value is written to a specified address...</p> |  <p>The object rotates.</p> | <ul style="list-style-type: none"> ☞ Setup Procedure (page 20-16) ☞ Introduction (page 20-16) |
| Changing Object Colors based on Address Values | | |
|  <p>When a value exceeds a certain value...</p> |  <p>The color of the placed object changes.</p> | <ul style="list-style-type: none"> ☞ Setup Procedure (page 20-16) ☞ Introduction (page 20-19) |

20.3 Showing and Hiding Objects

20.3.1 Introduction

Set up Visibility Animation to show or hide (Visible/Invisible) objects.

Switch between showing or hiding the based on a defined trigger, such as when the specified bit turns ON.

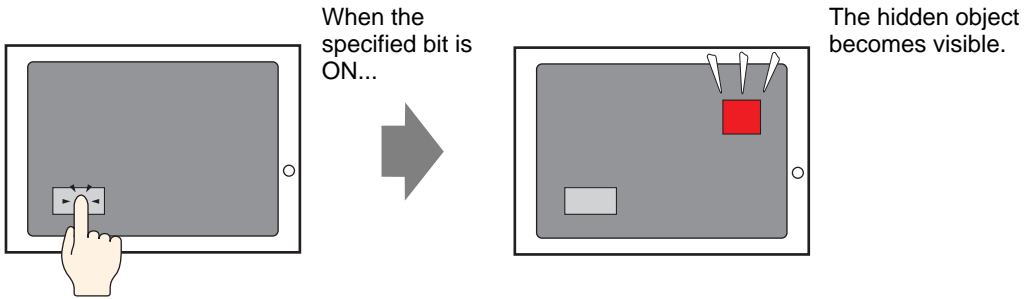

20.3.2 Setup Procedure

Display a hidden switch by turning ON bit M100.

NOTE

- Please refer to the Settings Guide for details.
 ☞ "20.7 Settings Guide" (page 20-22)

- 1 Select the switch you want to show or hide. From the [Edit (E)] menu select [Animation (N)], or right-click the switch and select [Animation (N)].

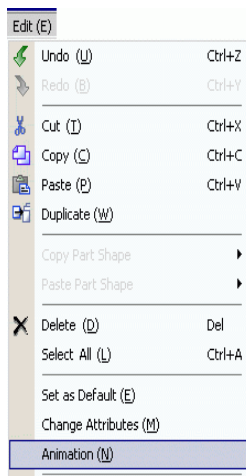

NOTE

- You can display the animation dialog box using one of the following procedures.
 - Select a drawing, then in the [Properties (P)] window select [Animation], and click the ellipsis [...].

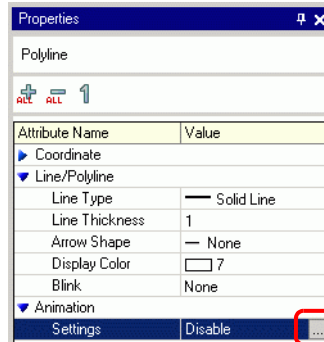

- In the [Screen Data List], double-click the [Animation] field of parts you want to edit.

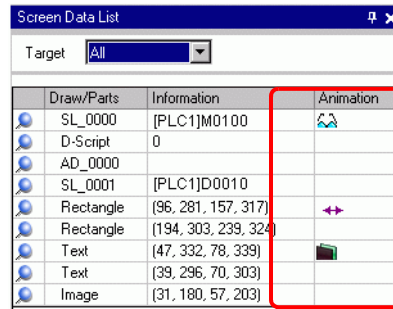

2 The [Animation Settings] dialog box appears. On the left pane, select [Visibility Animation].

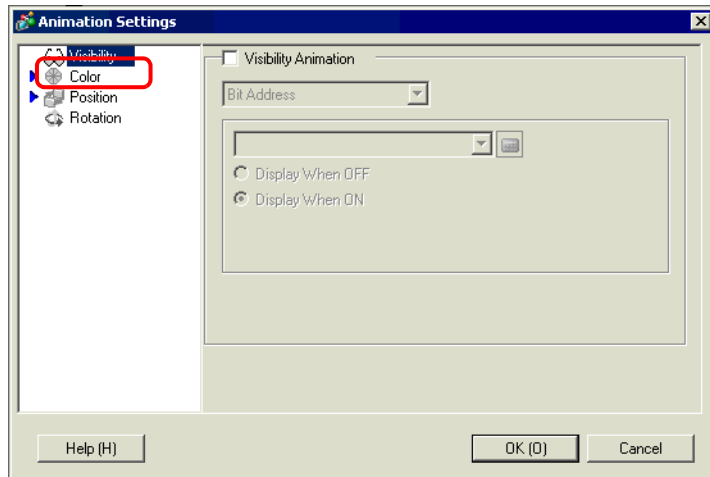

3 Select the [Visibility Animation] check box.

4 Select [Bit Address] and enter the address (M100) used to run the visibility operation.

20.3.3 Visibility Animation: Operation

This section describes how an object behaves when set up with Visibility Animation.

■ When an Object is Hidden

- If you touch the area of a hidden object, its associated touch operations will not run. However, it continues its internal processes, such as getting specified address values.

■ When a Displayed Object is Hidden

- When an object is hidden while it is touched, associated touch operations will not run.
- Even when interlock is on, Visibility Animation is run when triggered.
- If an object set up with security is hidden while in the middle of its touch operation, the security password screen will display. Upon entering the password to remove security, the object will remain hidden, but you will be able to run any features set up on the object.
- When a switch set up with ON Delay is hidden, functions set up in the switch will not run.
- If a Data Display is set up to allow input when its bit is ON, and the Data Display is hidden, its "ON" state is maintained even while hidden. As a result, when the object is displayed again it will return to its Allow Input state. You cannot input data while the Data Display is hidden.
- A buzzer stops when its associated switch is hidden.
- Even if a window display switch is hidden, its associated popup window will continue to display.
- Even if an alarm part is hidden, its associated Sub-Display Screen will continue to display.
- When an alarm is hidden while the alarm is in Freeze Mode, Freeze Mode cannot be removed.
- When a historical trend graph is hidden while displaying historical data, you cannot exit the historical data display.

■ When a Hidden Object is Shown

- When an object becomes visible in the middle of a touch, associated touch actions will not run until you touch the object again.
- When an object becomes visible, the object is displayed in the same state as before it was hidden, with the following exceptions.
 - Alarm cursor is moved while the alarm is hidden. The alarm cursor displays in its new position.
 - Selector List is closed, even if the list was open when the object was hidden.
- When the Monitor Word Address value changes while its associated Text Display is hidden, the display is updated with new values when it shown again.
- When a Text Display's [Display Update Condition] is set to [Bit ON], and the text is changes while hidden, the text display is updated even while hidden.

20.4 Moving Objects to show Changes in Condition

20.4.1 Introduction

Set up animation that moves objects on the screen.

Objects can move horizontally or vertically, depending on specified address values.

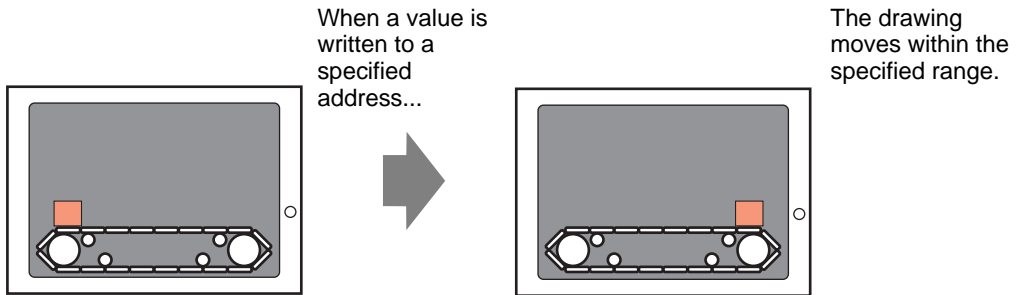

20.4.2 Setup Procedure

Use the current position as the start point, and set the horizontal end point 200 pixels away. The Position Range is from 0 to 200.

NOTE

- Please refer to the Settings Guide for details.
 ☞ "20.7 Settings Guide" (page 20-22)

- 1 Select the object to move then from the [Edit (E)] menu click [Animation (N)], or right-click the object and select [Animation (N)].

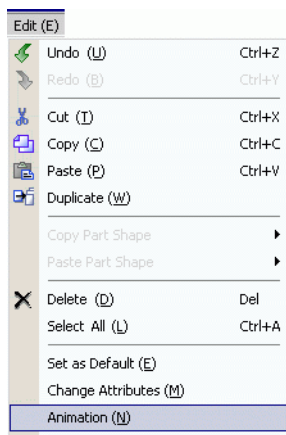

NOTE

- You can display the animation dialog box using one of the following procedures.
 - Select a drawing, then in the [Properties (P)] window select [Animation], and click the ellipsis [...].

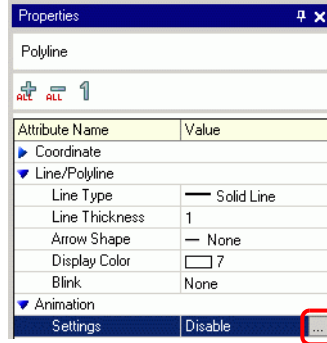

- In the [Screen Data List], double-click the [Animation] field of parts you want to edit.

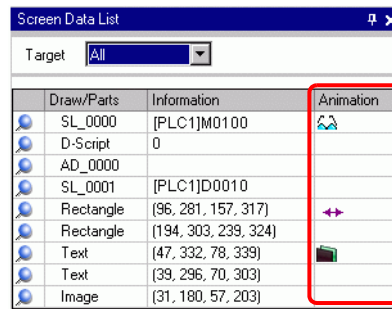

2 The [Animation Settings] dialog box appears. On the left pane, expand [Position] and select [Horizontal].

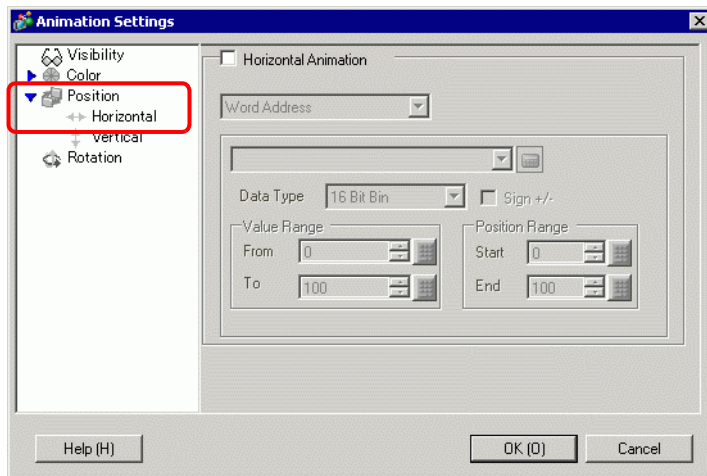

3 Select the [Horizontal Animation] check box.

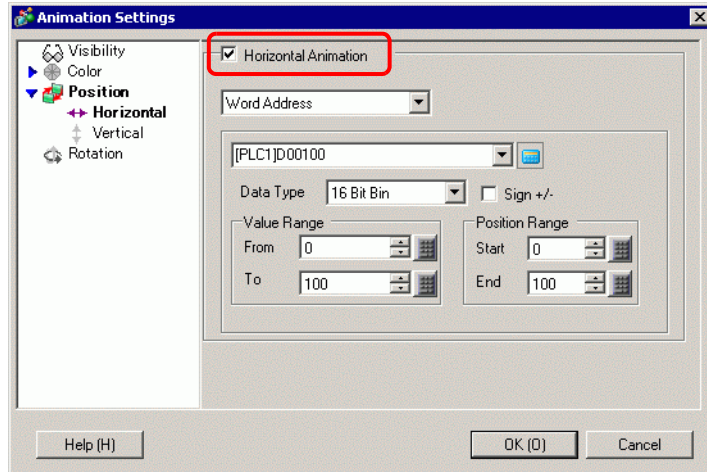

4 Enter the address that defines how much to move. For example, D100.

5 Select the [Data Type]. For example, 16 Bit Bin.

6 For the [Value Range] enter the [From] and [To] values. For example, From = 0, To = 100.

NOTE

- In the screen editor, if you place an object outside the visible screen area, you can specify that point as 0 in the [Value Range]. You can move and display the part from outside the screen area. In the [Value Range]'s [To] field, please enter a value less than or equal to the screen size. Otherwise, the part will not display.

7 Select the [Position Range]'s [Start] and [End] points. For example, Start = 0 and End = 200.

8 Click [OK (O)].

20.4.3 How Position Animation Works

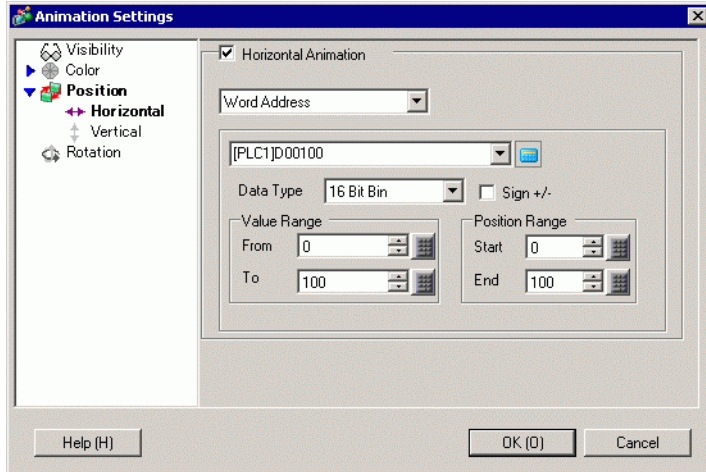

Setting Example: Horizontal Animation

Expression = D100

| | | |
|----------------|---------|-----|
| Value Range | From = | 0 |
| | To = | 100 |
| Position Range | Start = | 0 |
| | End = | 200 |

NOTE • In the screen editor, if you place an object outside the visible screen area, you can specify that point as 0 in the [Value Range]. You can move and display the part from outside the screen area. In the [Value Range]'s [To] field, please enter a value less than or equal to the screen size. Otherwise, the part will not display.

■ [D100] = 50

The object's top-left corner coordinate is calculated by adding the [Position Range]'s [Start] value with the coordinates of where the object was placed.

The coordinates obtained by adding [Position Range]'s [End] value with the coordinates of where the object was placed gives you the maximum target point.

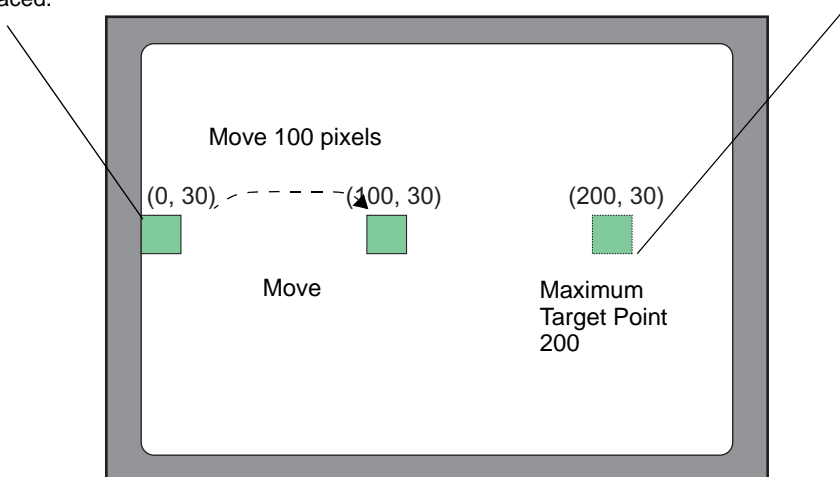

* (0,30) refers to the X,Y coordinates of the object's top-left corner.

Because the difference in the [Value Range]'s [From] and [To] fields is 100, the amount of movement is calculated based on the ratio between the value in address D100 and 100.

■ [D100] = -10

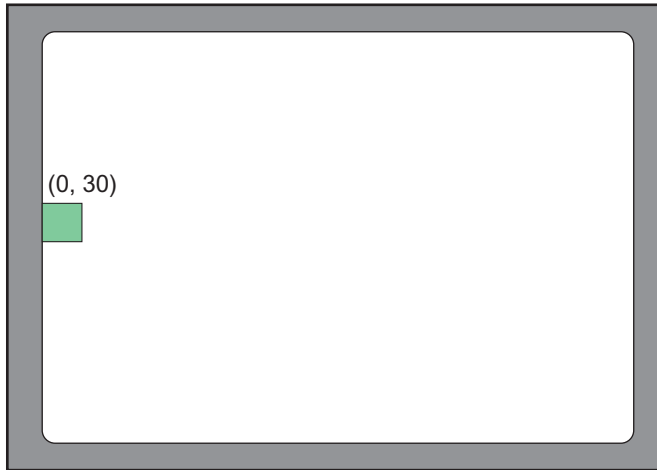

* (0,30) refers to the X,Y coordinates of the object's top-left corner.

When the stored value is less than the [Value Range]'s [From] value, the object does not move from its [Start] position.

■ [D100] = 300

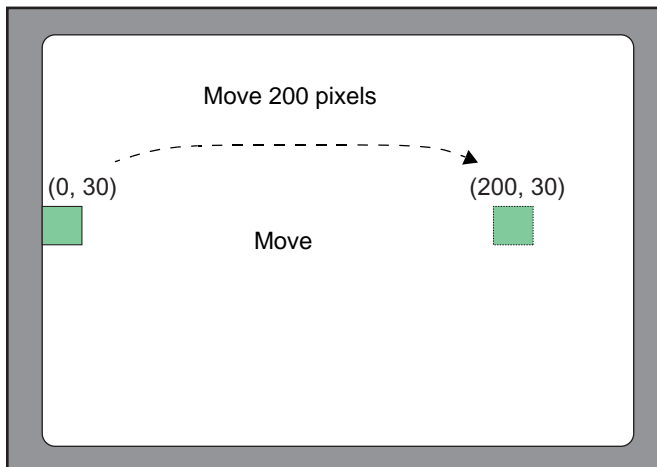

* (0,30) refers to the X,Y coordinates of the object's top-left corner.

When the stored value is greater than the [Value Range]'s [To] value, the object moves only up to its [End] position.

20.5 Rotating Objects to show Changes in Condition

20.5.1 Introduction

Set up animation that rotates objects on the screen.

Objects can be rotated depending on specified address values.

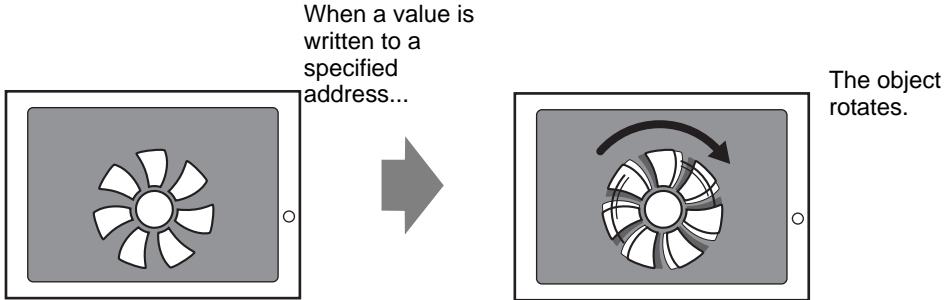

20.5.2 Setup Procedure

Use the current position as the start point, and set the clockwise rotation to 360 degrees.

NOTE

- Please refer to the Settings Guide for details.
 ☞ "20.7 Settings Guide" (page 20-22)

- 1 Select the object to move then from the [Edit (E)] menu click [Animation (N)], or right-click the object and select [Animation (N)].

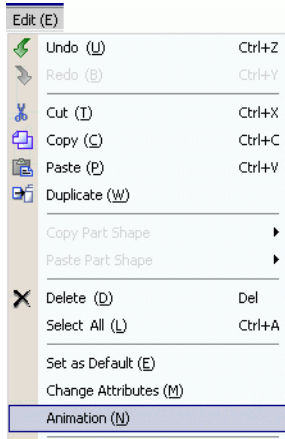

NOTE

- You can display the animation dialog box using one of the following procedures.
 - Select a drawing, then in the [Properties (P)] window select [Animation], and click the ellipsis [...].

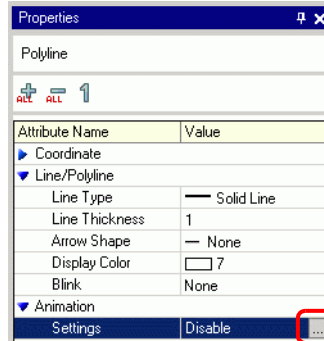

- In the [Screen Data List], double-click the [Animation] field of parts you want to edit.

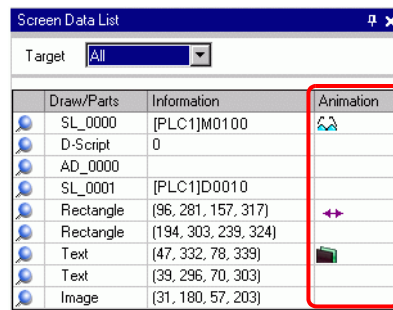

2 The [Animation Settings] dialog box appears. On the left pane, select [Rotation].

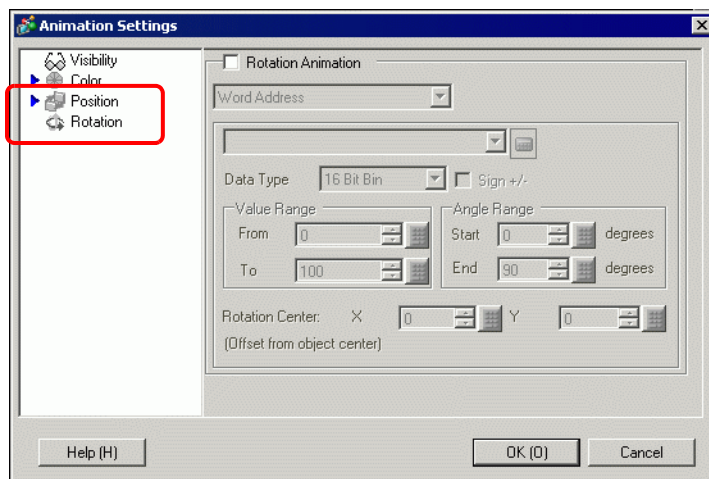

3 Select the [Rotation Animation] check box.

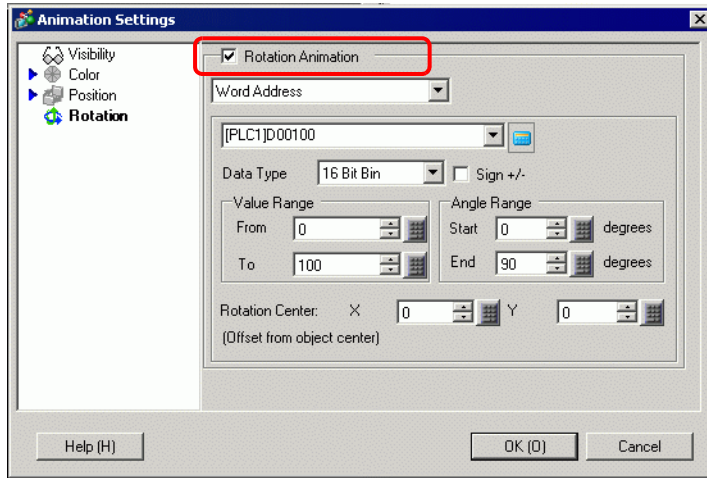

4 Enter the address that defines how much to rotate. For example, D100

5 Select the [Data Type]. For example, 16 Bit Bin.

6 For the [Value Range] enter the [From] and [To] values. For example, Start = 0 and End = 100.

NOTE

- In the screen editor, if you place an object outside the visible screen area, you can specify that point as 0 in the [Value Range]. You can rotate and display the part from outside the screen area. Depending on the value you set in [Value Range]'s To field, the object can be rotated outside the screen display area until it does not display anymore.

7 Select the [Angle Range]'s [Start] and [End] degrees. For example, Start = 0 and End = 360.

8 Click [OK (O)].

NOTE

- When the Angle Range's Start value is larger than the End value, the object will rotate counterclockwise. You can set negative values.
-

20.6 Changing Object Colors based on Address Values

20.6.1 Introduction

Set up animation that changes colors of an object on the screen.

Object colors can change depending on specified address values.

This is useful when, for example, you want to highlight the display by changing its color when it exceeds a certain value.

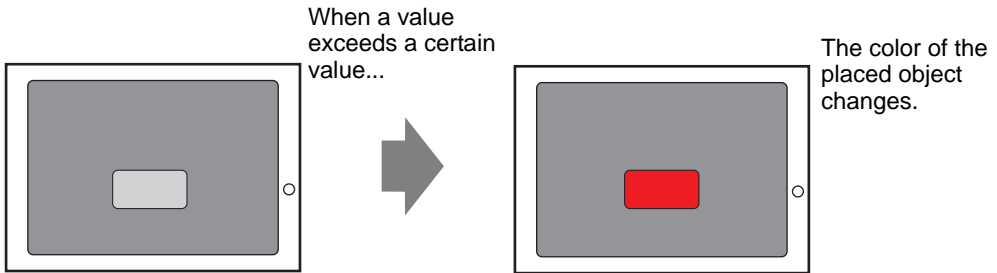

20.6.2 Setup Procedure

Set up animation that changes the text background color from green to red when M100 turns ON.

NOTE

- Please refer to the Settings Guide for details.
 ☞ "20.7 Settings Guide" (page 20-22)

- 1 Select the object that will change its background color, then from the [Edit (E)] menu click [Animation (N)], or right-click the object and select [Animation (N)].

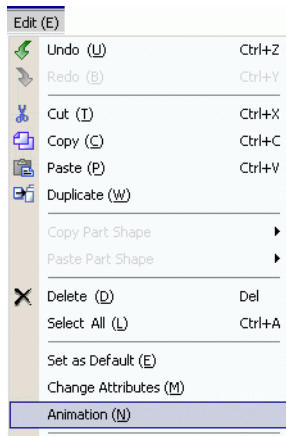

NOTE

- You can display the animation dialog box using one of the following procedures.
 - Select a drawing, then in the [Properties (P)] window select [Animation], and click the ellipsis [...].

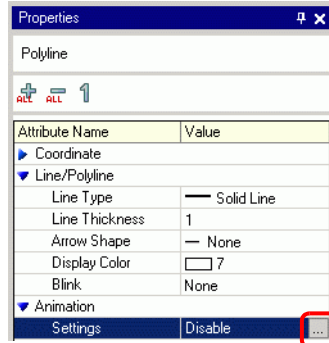

- In the [Screen Data List], double-click the [Animation] field of parts you want to edit.

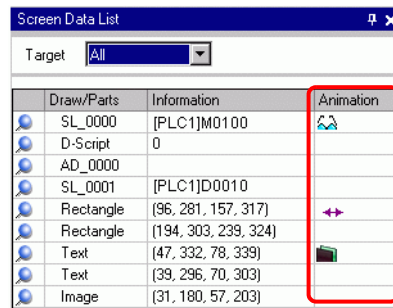

2 The [Animation Settings] dialog box appears. On the left pane, expand [Color] and select [Background].

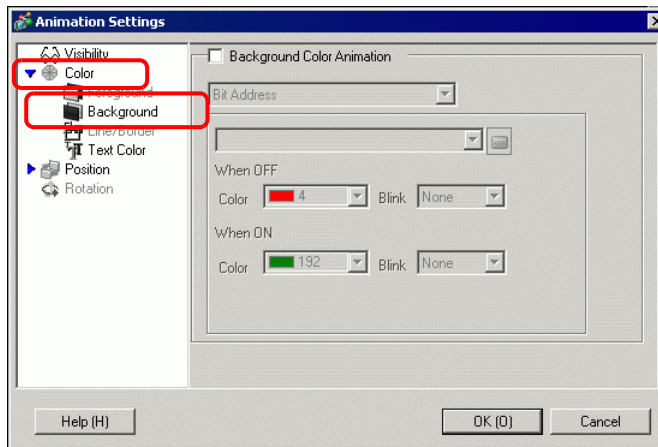

3 Select the [Background Color Animation] check box.

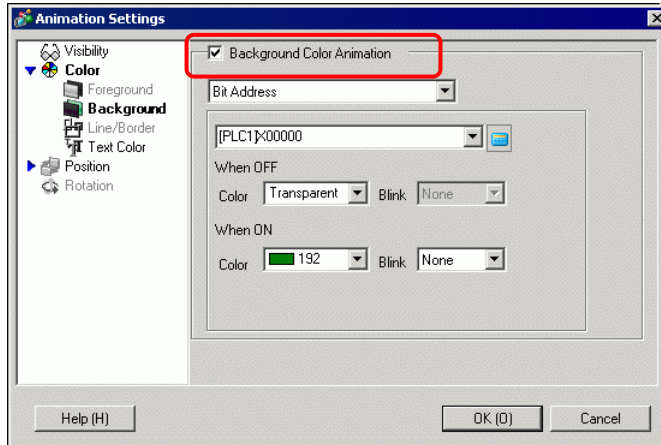

4 Select [Bit Address] and then define the address. For example, M100.

For [When OFF] set [Color] to green. For [When ON] set [Color] to red, and then click [OK].

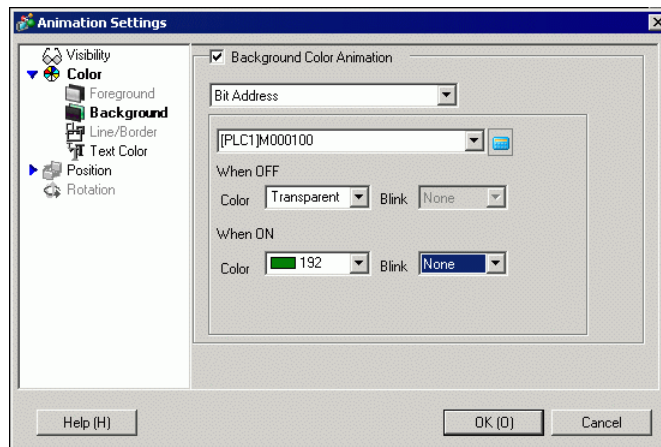

NOTE

- Color Animation works only if the object is set up with filling.
- When using blink, the blink set up in the part is overridden by the blink set up in Color Animation.

20.7 Settings Guide

20.7.1 [Animation Settings] Settings Guide

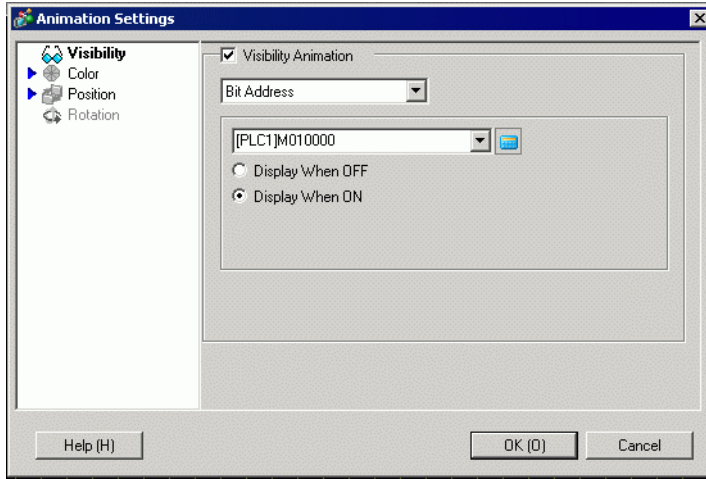

■ Visibility Animation

Set up Visibility Animation to show or hide objects.

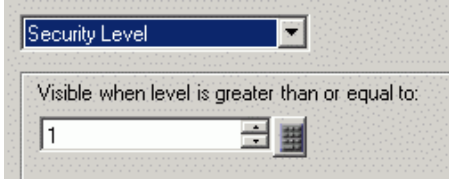



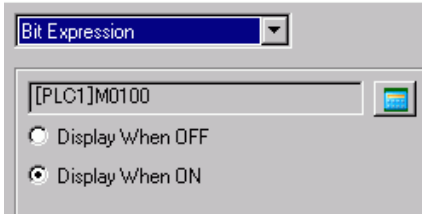

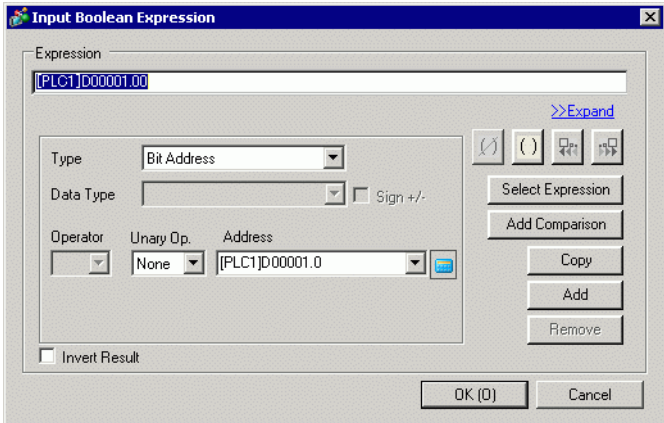
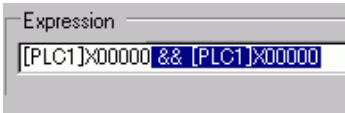
| Setting | Description |
|--|---|
| Visibility Animation | Adds Visibility Animation. |
| Bit Address | Visibility animation is based on the ON/OFF value of the specified bit address. |
| Display When OFF | The object is visible when the specified bit address is OFF. |
| Display When ON | The object is visible when the specified bit address is ON. |
| Security Level | The object is displayed only when you log on at a level equal to or higher than the defined security level.  |
| Visible when level is greater than or equal to | Define the minimum security level required to view the object. Set a value between 1 and 15. |

Continued

| Setting | | Description |
|----------------------|---|--|
| Visibility Animation | Expression | <p>Visibility animation is based on the ON/OFF value of the specified bit expression.</p>  |
| | Display When OFF | The object is visible when the defined bit expression is OFF. |
| | Display When ON | The object is visible when the defined bit expression is ON. |
| | | <p>Click  to display the [Bool Expression] dialog box. Set the details of the expression.</p>  |
| | Expression | <p>Define the expression. You cannot type the expression. Click inside the expression to select and define that portion.</p>  |
| | Type | <p>Select the type of conditional expression.</p> <ul style="list-style-type: none"> • Bit Address Sets up bit addresses in the expression. |
| | Data Type | Select the data type. If you set [Type] = [Word Address], select [16 Bit Bin], [16 Bit BCD], [32 Bit Bin] or [32 Bit BCD]. If you set [Type] = [Constant], select [Dec], [Hex] or [Octal]. |
| Operator | <p>Set up an operator. Select && or .</p> <p>If you added a comparison to the expression, select >, <, >=, <=, ==, or !=.</p> | |

Continued

| Setting | | Description |
|----------------------|------------|---|
| Visibility Animation | Expression | Unary Op. Set up an unary operator. ! or None is available. If you added a comparison to the expression, select "-", "~", or None. |
| | | Address Set the address. |
| | | Invert Result Inverts the result of the conditional expression. |
| | | Expand Enlarges the script Expression area. |
| | |  Removes parentheses set up with (). |
| | |  Adds parentheses around the selected portion of the expression. |
| | |  Moves the selected portion to the left side of the operator. |
| | |  Moves the selected portion to the right side of the operator. |
| | | Select Expression Selects the entire expression. |
| | | Add Comparison Adds a comparison to the expression. |
| | | Copy Copies and adds the selected expression. NOTE • The expression cannot be copied when using a comparison operator. |
| | | Add Adds a condition to the expression. Please enter the address manually. |
| | | Remove Removes the selected portion of the expression. You cannot select and delete the entire expression. |

■ Color Animation

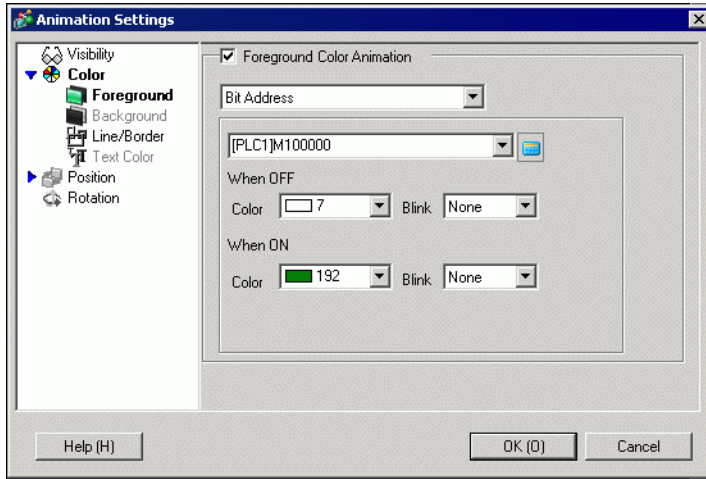



| Setting | | Description | |
|---------|-------------|--|---|
| Color | | Select the item you want to set up with Color Animation. <ul style="list-style-type: none"> • Foreground Color Animation Changes the color of the object's fill. • Background Color Animation Changes the object's background color. • Line/Border Color Animation Changes the color of the object's line or border. • Text Color Animation Changes the object's text color. | |
| | Bit Address | The color changes when the specified bit turns ON/OFF. | |
| | When OFF | Color | Defines the color when the specified bit is OFF. |
| | | Blink | Select the blink speed. NOTE <ul style="list-style-type: none"> • There are cases where you can and cannot set Blink depending on the Display Unit and System Settings' [Color Settings]. ☞ "8.5.1 Setting Colors ■ List of Compatible Colors" (page 8-36) |
| When ON | Color | Defines the color when the specified bit is ON. | |
| | Blink | Select the blink speed. NOTE <ul style="list-style-type: none"> • There are cases where you can and cannot set Blink depending on the Display Unit and System Settings' [Color Settings]. ☞ "8.5.1 Setting Colors ■ List of Compatible Colors" (page 8-36) | |

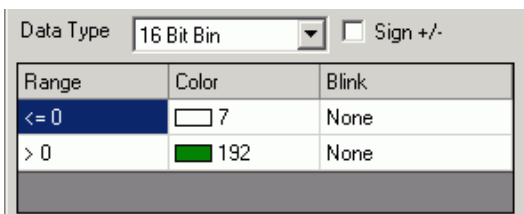

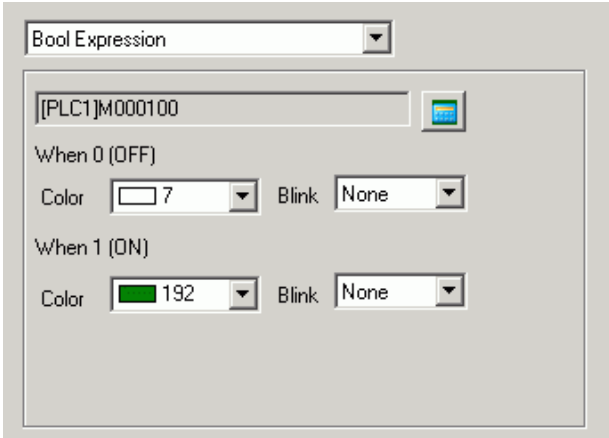

Continued

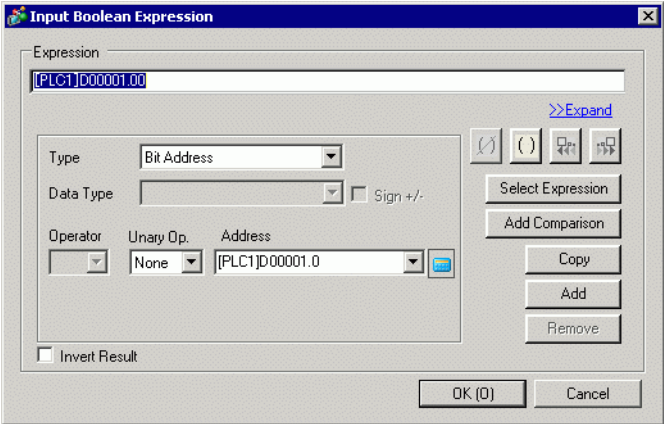
| Setting | | Description |
|---------|--------------|---|
| Color | Word Address | <p>The color changes when the value changes in the specified word address.</p>  |
| | Data Type | Select the data type. When using [Word Address], select [16 Bit Bin], [16 Bit BCD], [32 Bit Bin], or [32 Bit BCD]. |
| | Sign +/- | Defines whether the negative sign is used in the display. Set up when you want to display negative values. Negative values are handled using 2's Complement. This is available when the [Data Type] is [16 Bit Bin] or [32 Bit Bin]. |
| | Range | Define the range of values for the associated color. |
| | Color | Select the color for each specified range. |
| | Blink | <p>Select the blink speed.</p> <p>NOTE</p> <ul style="list-style-type: none"> There are cases where you can and cannot set Blink depending on the Display Unit and System Settings' [Color Settings]. <p>☞ "8.5.1 Setting Colors ■ List of Compatible Colors" (page 8-36)</p> |
| | Add | Adds a color range. |
| | Remove | Removes the selected range. |

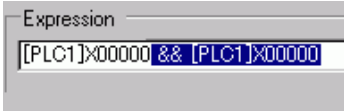

Continued

| Setting | | Description | |
|---------|------------|---|---|
| Color | Expression | <p>The color changes when the value of the specified expression changes.</p>  | |
| | When OFF | Color | Select the color when the specified expression is OFF. |
| | | Blink | <p>Select the blink speed.</p> <p>NOTE</p> <ul style="list-style-type: none"> • There are cases where you can and cannot set Blink depending on the Display Unit and System Settings' [Color Settings]. <p>☞ "8.5.1 Setting Colors ■ List of Compatible Colors" (page 8-36)</p> |
| | When ON | Color | Select the color when the specified expression is ON. |
| | | Blink | <p>Select the blink speed.</p> <p>NOTE</p> <ul style="list-style-type: none"> • There are cases where you can and cannot set Blink depending on the Display Unit and System Settings' [Color Settings]. <p>☞ "8.5.1 Setting Colors ■ List of Compatible Colors" (page 8-36)</p> |
| | | | <p>Click  to display the [Bool Expression] dialog box. Set the details of the expression.</p>  |



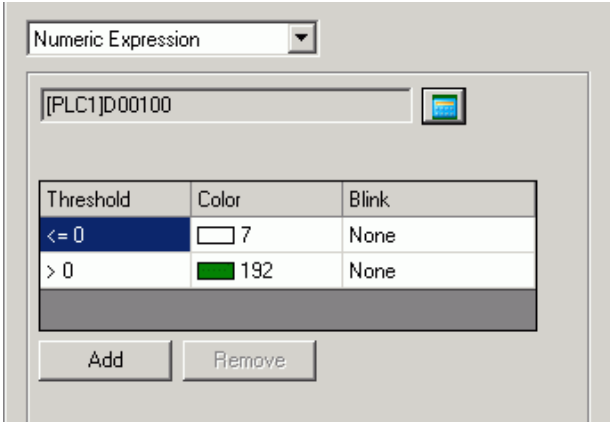

Continued

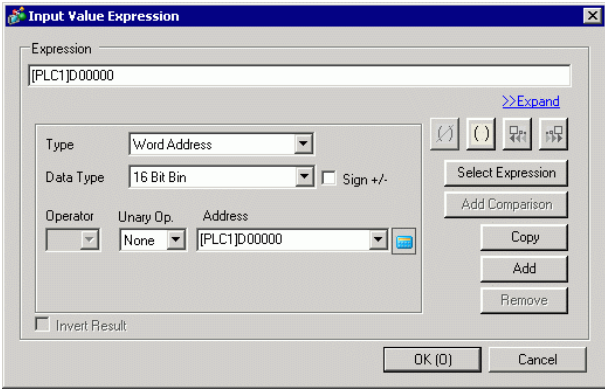
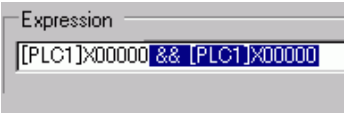
| Setting | | Description |
|---------------------|---|--|
| Color Expression | Expression | <p>Define the expression. You cannot type the expression. Click inside the expression to select and define that portion.</p>  |
| | Type | <p>Select the type of conditional expression.</p> <ul style="list-style-type: none"> • Bit Address Sets up bit addresses in the expression. |
| | Operator | <p>Set up an operator. Select && or .</p> <p>If you added a comparison to the expression, select >, <, >=, <=, ==, or !=.</p> |
| | Unary Op. | <p>Set up an Unary operator. ! or None is available.</p> <p>If you added a comparison to the expression, select "-", "~", or None.</p> |
| | Address | Set the address. |
| | Invert Result | Inverts the result of the conditional expression. |
| | Expand | Enlarges the script Expression area. |
| |  | Removes parentheses set up with (). |
| |  | Adds parentheses around the selected portion of the expression. |
| |  | Moves the selected portion to the left side of the operator. |
| |  | Moves the selected portion to the right side of the operator. |
| | Select Expression | Selects the entire expression. |
| | Add Comparison | Adds a comparison to the expression. |
| | Copy | <p>Copies and adds the selected expression.</p> <p>NOTE</p> <ul style="list-style-type: none"> • The expression cannot be copied when using a comparison operator. |
| | Add | Adds a condition to the expression. Please enter the address manually. |
| Remove | Removes the selected portion of the expression. You cannot select and delete the entire expression. | |

Continued

| Setting | Description |
|--|--|
| <p style="writing-mode: vertical-rl; transform: rotate(180deg);">Color</p> | <p>The color changes to match the value in the associated address.</p>  |
| | <p>Range</p> <p>Define the range of values for the associated color.</p> |
| | <p>Color</p> <p>Set the color for each specified range.</p> |
| | <p>Blink</p> <p>Select the blink speed.</p> <p>NOTE</p> <ul style="list-style-type: none"> There are cases where you can and cannot set Blink depending on the Display Unit and System Settings' [Color Settings]. <p>☞ "8.5.1 Setting Colors ■ List of Compatible Colors" (page 8-36)</p> |
| | <p>Add</p> <p>Adds a color range.</p> |
| | <p>Remove</p> <p>Removes the selected range.</p> |
| | <p>Click [] to display the [Value Expression] dialog box. Set the details of the expression.</p>  |
| <p>Expression</p> | <p>Define the expression. You cannot type the expression. Click inside the expression to select and define that portion.</p>  |

Continued

| Setting | | Description |
|---|------------|--|
| Color | Expression | Type <ul style="list-style-type: none"> Select the type of conditional expression: [Word Address] or [Constant]. • Word Address Sets up word addresses in the expression. • Constant Sets up values to change the color between 0 and 4294967295. |
| | | Data Type <p>Select the data type. If you set [Type] = [Word Address], select [16 Bit Bin], [16 Bit BCD], [32 Bit Bin] or [32 Bit BCD]. If you set [Type] = [Constant], select [Dec], [Hex] or [Octal].</p> |
| | | Sign +/- <p>Defines whether the negative sign is used in the display. Set up when you want to display negative values. Negative values are handled using 2's Complement. This is available when the [Data Type] is [16 Bit Bin] or [32 Bit Bin].</p> |
| | | Operator <p>Set up an operator. +, -, /, *, &, , ^, %, <<, and >> are available.</p> |
| | | Unary Op. <p>Set up an Unary operator. ~ or None is available.</p> |
| | | Address <p>Set the address.</p> |
| | | Expand <p>Enlarges the script Expression area.</p> |
| | |  <p>Removes parentheses set up with <input type="text" value="()"/>.</p> |
| | |  <p>Adds parentheses around the selected portion of the expression.</p> |
| | |  <p>Moves the selected portion to the left side of the operator.</p> |
| | |  <p>Moves the selected portion to the right side of the operator.</p> |
| | | Select Expression <p>Selects the entire expression.</p> |
| | | Add Comparison <p>Adds a condition to the expression.</p> |
| | | Copy <p>Copies and adds the selected expression.</p> <p>NOTE</p> <ul style="list-style-type: none"> • The expression cannot be copied when using a comparison operator. |
| | | Add <p>Adds a condition to the expression. Please enter the address manually.</p> |
| Remove <p>Removes the selected portion of the expression. You cannot select and delete the entire expression.</p> | | |

◆ Hue Animation

This can be applied to images only. In the image, expand [Color] and select [Foreground Color] to display the [Hue] setting.

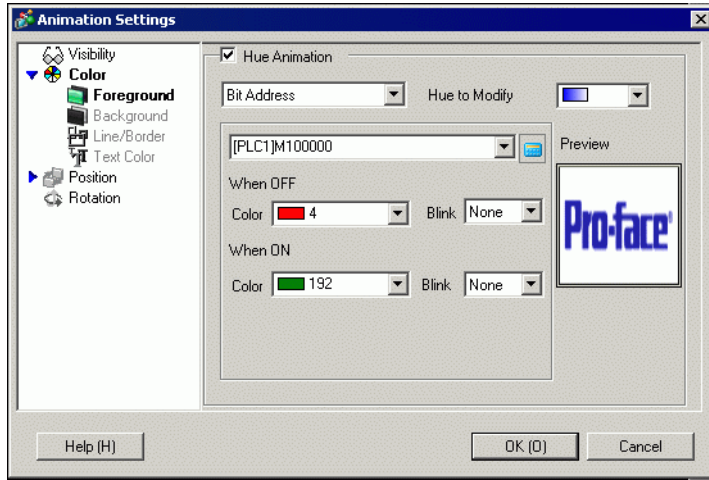

NOTE

- Depending on the [Target Hue], the brightness or saturation may not change from the original image, which could result in the tone being different from the specified color.

| Setting | | Description | |
|---------------|------------|--|---|
| Hue Animation | Target Hue | Select the color that will change in the Hue animation. The list shows the top 20 colors used in the selected image. You can change only one of these specified colors. As an alternative, you can change the entire image into one flat color by selecting [ALL]. | |
| | When OFF | Color | Select the color when the specified expression is OFF. |
| | | Blink | Select the blink speed. NOTE • There are cases where you can and cannot set Blink depending on the Display Unit and System Settings' [Color Settings]. ☞ "8.5.1 Setting Colors ■ List of Compatible Colors" (page 8-36) |
| | When ON | Color | Select the color when the specified expression is ON. |
| | | Blink | Select the blink speed. NOTE • There are cases where you can and cannot set Blink depending on the Display Unit and System Settings' [Color Settings]. ☞ "8.5.1 Setting Colors ■ List of Compatible Colors" (page 8-36) |
| | Preview | Previews the specified image. | |

■ Position Animation

◆ Horizontal Animation

Set up animation that moves objects horizontally relative to a defined value.

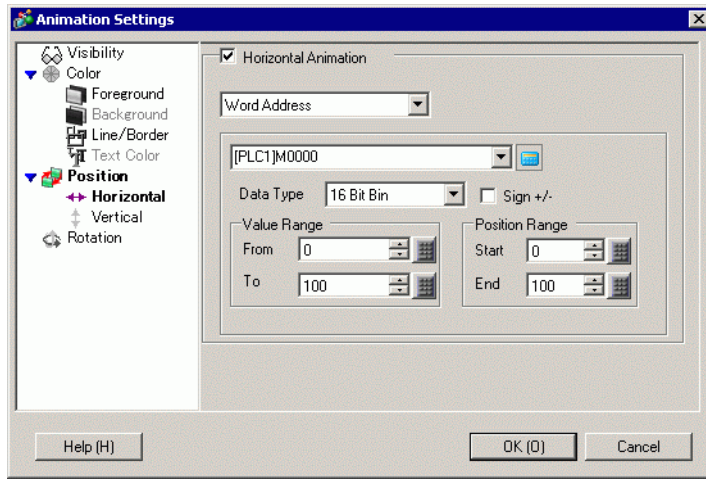



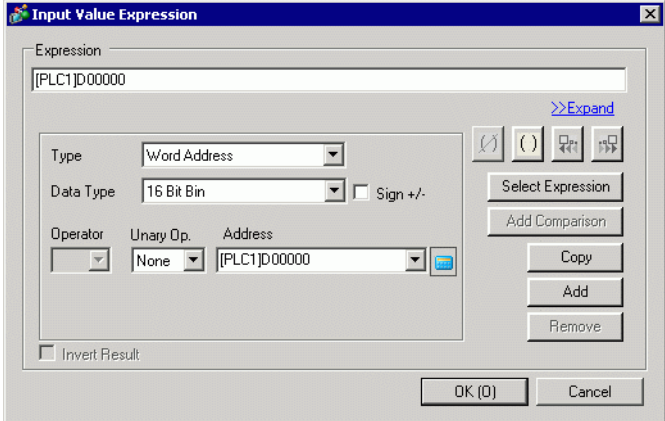
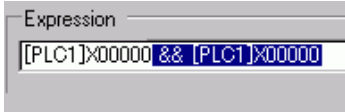

| Setting | | Description | |
|----------------------|--------------|----------------|---|
| Horizontal Animation | Word Address | Data Type | Select the [Data Type]. [16 Bit Bin], [32 Bit Bin], [16 Bit BCD], or [32 Bit BCD] data types are available. |
| | | Sign +/- | Defines whether the negative sign is used in the display. Set up when you want to display negative values. Negative values are handled using 2's Complement. This is available when the [Data Type] is [16 Bit Bin] or [32 Bit Bin]. |
| | | Value Range | Set up the range of values on the address. This corresponds to the [Position Range]'s [Start] and [End] values. <ul style="list-style-type: none"> From Specifies the start point from which it will move. To Specifies the end point. The object does not move any farther. |
| | | Position Range | Sets up the range of movement for the object (as an offset from the original object location). <ul style="list-style-type: none"> Start Defines the start point for object movement. This value is an offset from the original object coordinate. End Defines the end point for object movement. This value is an offset from the original object coordinate. |

Continued

| | Setting | Description |
|----------------------|----------------|--|
| Horizontal Animation | Expression | <p>Click [] to display the [Value Expression] dialog box. Set the details of the expression.</p>  |
| | Value Range | <p>Set up the range of values on the address. This corresponds to the [Position Range]'s [Start] and [End] values.</p> <ul style="list-style-type: none"> • From Specifies the start point from which it will move. • To Specifies the end point. The object does not move any farther. |
| | Position Range | <p>Sets up the range of movement for the object (as an offset from the original object location).</p> <ul style="list-style-type: none"> • Start Defines the start point for object movement. This value is an offset from the original object coordinate. • End Defines the end point for object movement. This value is an offset from the original object coordinate. |
| | Expression | <p>Define the expression. You cannot type the expression. Click inside the expression to select and define that portion.</p>  |
| | Type | <p>Select the type of conditional expression: [Word Address] or [Constant].</p> <ul style="list-style-type: none"> • Word Address Sets up word addresses in the expression. • Constant Enter the values that define how much to move between 0 and 4294967295. |

Continued

| Setting | | Description | |
|----------------------|------------|---|--|
| Horizontal Animation | Expression | Data Type | Select the data type. If you set [Type] = [Word Address], select [16 Bit Bin], [16 Bit BCD], [32 Bit Bin] or [32 Bit BCD]. If you set [Type] = [Constant], select [Dec], [Hex] or [Octal]. |
| | | Sign +/- | Defines whether the negative sign is used in the display. Set up when you want to display negative values. Negative values are handled using 2's Complement. This is available when the [Data Type] is [16 Bit Bin] or [32 Bit Bin]. |
| | | Operator | Set up an operator. +, -, /, *, &, , ^, %, <<, and >> are available. |
| | | Unary Op. | Set up an Unary operator. ~ or None is available. |
| | | Address | Set the address. |
| | | Expand | Enlarges the script Expression area. |
| | |  | Removes parentheses set up with  . |
| | |  | Adds parentheses around the selected portion of the expression. |
| | |  | Moves the selected portion to the left side of the operator. |
| | |  | Moves the selected portion to the right side of the operator. |
| | | Select Expression | Selects the entire expression. |
| | | Add Comparison | Adds a condition to the expression. |
| | | Copy | Copies and adds the selected expression. NOTE • The expression cannot be copied when using a comparison operator. |
| | | Add | Adds a condition to the expression. Please enter the address manually. |
| | | Remove | Removes the selected portion of the expression. You cannot select and delete the entire expression. |

◆ **Vertical Animation**

Set up animation that moves objects vertically relative to a defined value.

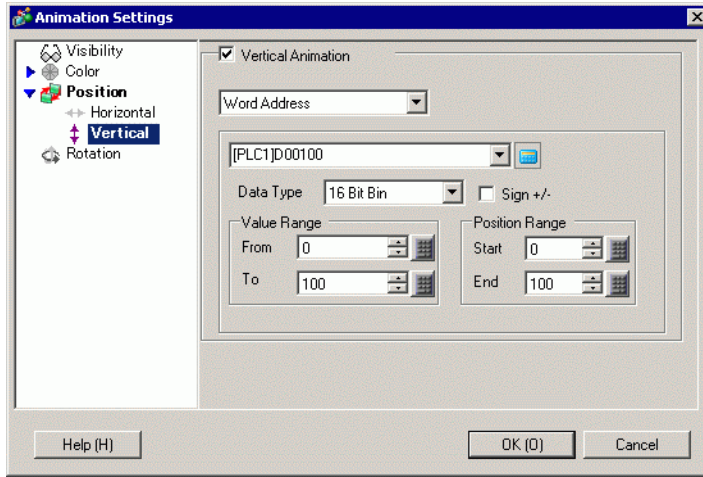



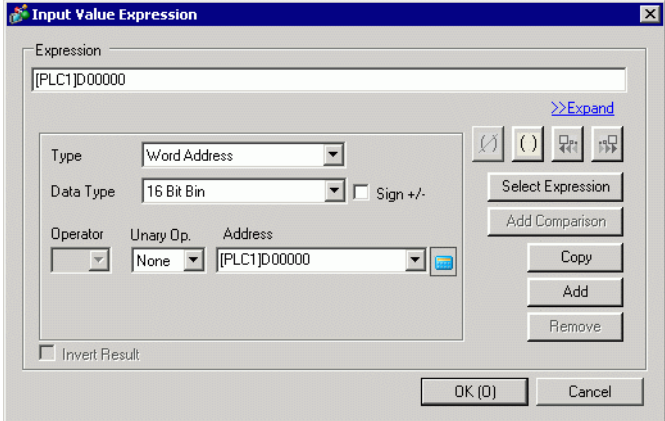
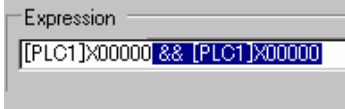

| Setting | | Description | |
|--------------------|--------------|----------------|---|
| Vertical Animation | Word Address | Data Type | Select the [Data Type]. [16 Bit Bin], [32 Bit Bin], [16 Bit BCD], or [32 Bit BCD] data types are available. |
| | | Sign +/- | Defines whether the negative sign is used in the display. Set up when you want to display negative values. Negative values are handled using 2's Complement. This is available when the [Data Type] is [16 Bit Bin] or [32 Bit Bin]. |
| | | Value Range | Set up the range of values on the address. This corresponds to the [Position Range]'s [Start] and [End] values. <ul style="list-style-type: none"> • From Specifies the start point from which it will move. • To Specifies the end point. The object does not move any farther. |
| | | Position Range | Sets up the range of movement for the object (as an offset from the original object location). <ul style="list-style-type: none"> • Start Defines the start point for object movement. This value is an offset from the original object coordinate. • End Defines the end point for object movement. This value is an offset from the original object coordinate. |

Continued

| Setting | | Description |
|--------------------|----------------|--|
| Vertical Animation | Expression | <p>Click  to display the [Value Expression] dialog box. Set the details of the expression.</p>  |
| | Value Range | <p>Set up the range of values on the address. This corresponds to the [Position Range]'s [Start] and [End] values.</p> <ul style="list-style-type: none"> • From Specifies the start point from which it will move. • To Specifies the end point. The object does not move any farther. |
| | Position Range | <p>Sets up the range of movement for the object (as an offset from the original object location).</p> <ul style="list-style-type: none"> • Start Defines the start point for object movement. This value is an offset from the original object coordinate. • End Defines the end point for object movement. This value is an offset from the original object coordinate. |
| | Expression | <p>Define the expression. You cannot type the expression. Click inside the expression to select and define that portion.</p>  |
| | Type | <p>Select the type of conditional expression: [Word Address] or [Constant].</p> <ul style="list-style-type: none"> • Word Address Sets up word addresses in the expression. • Constant Enter the values that define how much to move between 0 and 4294967295. |

Continued



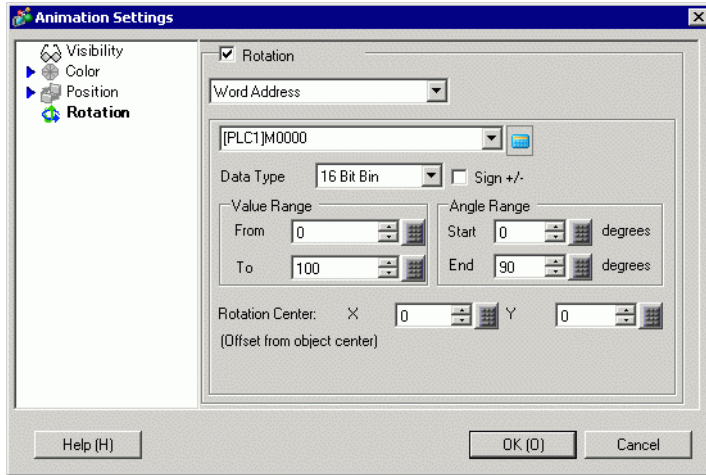

| Setting | | Description | |
|--------------------|---|---|--|
| Vertical Animation | Expression | Data Type | Select the data type. If you set [Type] = [Word Address], select [16 Bit Bin], [16 Bit BCD], [32 Bit Bin] or [32 Bit BCD]. If you set [Type] = [Constant], select [Dec], [Hex] or [Octal]. |
| | | Sign +/- | Defines whether the negative sign is used in the display. Set up when you want to display negative values. Negative values are handled using 2's Complement. This is available when the [Data Type] is [16 Bit Bin] or [32 Bit Bin]. |
| | | Operator | Set up an operator. +, -, /, *, &, , ^, %, <<, and >> are available. |
| | | Unary Op. | Set up an Unary operator. ~ or None is available. |
| | | Address | Set the address. |
| | | Expand | Enlarges the script Expression area. |
| | |  | Removes parentheses set up with  . |
| | |  | Adds parentheses around the selected portion of the expression. |
| | |  | Moves the selected portion to the left side of the operator. |
| | |  | Moves the selected portion to the right side of the operator. |
| | | Select Expression | Selects the entire expression. |
| | | Add Comparison | Adds a condition to the expression. |
| | | Copy | Copies and adds the selected expression. NOTE • The expression cannot be copied when using a comparison operator. |
| | | Add | Adds a condition to the expression. Please enter the address manually. |
| Remove | Removes the selected portion of the expression. You cannot select and delete the entire expression. | | |

■ Rotation Animation

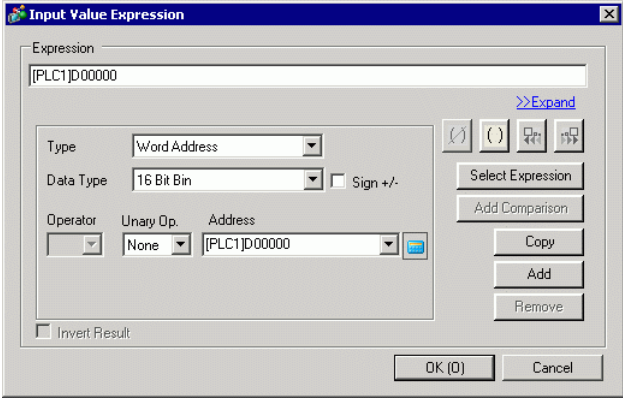
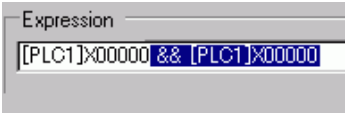

| Setting | | Description | |
|--------------------|--------------|-----------------|---|
| Rotation Animation | Word Address | Data Type | Select the [Data Type]. [16 Bit Bin], [32 Bit Bin], [16 Bit BCD], or [32 Bit BCD] data types are available. |
| | | Sign +/- | Defines whether the negative sign is used in the display. Set up when you want to display negative values. Negative values are handled using 2's Complement. This is available when the [Data Type] is [16 Bit Bin] or [32 Bit Bin]. |
| | | Value Range | Set up the range of values on the address. This corresponds to the [Angle Range]'s [Start] and [End] degrees. <ul style="list-style-type: none"> • From Specifies the start point from which it will move. • To Specifies the end point. The object does not rotate any farther. |
| | | Angle Range | Sets up the range of rotation angles for the object (as an offset from the original object position). <p>NOTE</p> <ul style="list-style-type: none"> • The angle of rotation is defined by dividing the Angle Range with the Value Range, which may not result in single degree units. To ensure rotation occurs in one degree units, use the following settings. (Value Range To - Value Range From) = (Angle Range End - Angle Range Start) |
| | | Rotation Center | Sets up the center point of the rotation. [X] is the left or right offset from the object's center point. [Y] is the top or bottom offset from the object's center point. |

Continued

| Setting | Description |
|--|--|
| Rotation Animation | <p>Click [] to display the [Value Expression] dialog box. Set the details of the expression.</p>  |
| | <p>Define the expression. You cannot type the expression. Click inside the expression to select and define that portion.</p>  |
| | <p>Select the type of conditional expression: [Word Address] or [Constant].</p> <ul style="list-style-type: none"> • Word Address Sets up word addresses in the expression. • Constant Enter the values that define how much to rotate between 0 and 4294967295. |
| | <p>Select the data type. If you set [Type] = [Word Address], select [16 Bit Bin], [16 Bit BCD], [32 Bit Bin] or [32 Bit BCD]. If you set [Type] = [Constant], select [Dec], [Hex] or [Octal].</p> |
| | <p>Defines whether the negative sign is used in the display. Set up when you want to display negative values. Negative values are handled using 2's Complement. This is available when the [Data Type] is [16 Bit Bin] or [32 Bit Bin].</p> |
| | <p>Operator Set up an operator. +, -, /, *, &, , ^, %, <<, and >> are available.</p> |
| | <p>Unary Op. Set up an Unary operator. ~ or None is available.</p> |
| | <p>Address Set the address.</p> |
| | <p>Expand Enlarges the script Expression area.</p> |
| | <p> Removes parentheses set up with ().</p> |
| <p> Adds parentheses around the selected portion of the expression.</p> | |
| <p> Moves the selected portion to the left side of the operator.</p> | |
| <p> Moves the selected portion to the right side of the operator.</p> | |

Continued

| Setting | | Description |
|--------------------|--------------------|---|
| Rotation Animation | Numeric Expression | Select Expression Selects the entire expression. |
| | | Add Comparison Adds a condition to the expression. |
| | | Copy NOTE • The expression cannot be copied when using a comparison operator. |
| | | Add Adds a condition to the expression. Please enter the address manually. |
| | | Remove Removes the selected portion of the expression. You cannot select and delete the entire expression. |

■ About Expressions

You can set up operation conditions for animation using expressions.

The expression is set by combining bit address, word address, constants and operators.

Expressions can include logical and arithmetic expressions. Logical expressions output either true or false. For example, $A > B$.

Arithmetic expressions output a numeric value. For example, $A + B$.

For [Bool Expression], ON/OFF is determined by whether the expression evaluates to true or false.

If the operation is set to run when ON, it runs when the expression is True, and does not run when the expression is False.

For [Value Expression], the operation is determined by a numeric value.

◆ Value Expression

Setting Example: Horizontal Animation

Position determined by the total of $D100 + D200$ (16 Bit Bin), multiplied by 10

- 1 Select the object to move then from the [Edit (E)] menu click [Animation (N)], or right-click the object and select [Animation (N)].
- 2 The [Animation Settings] dialog box appears. On the left pane, expand [Position] and select [Horizontal].

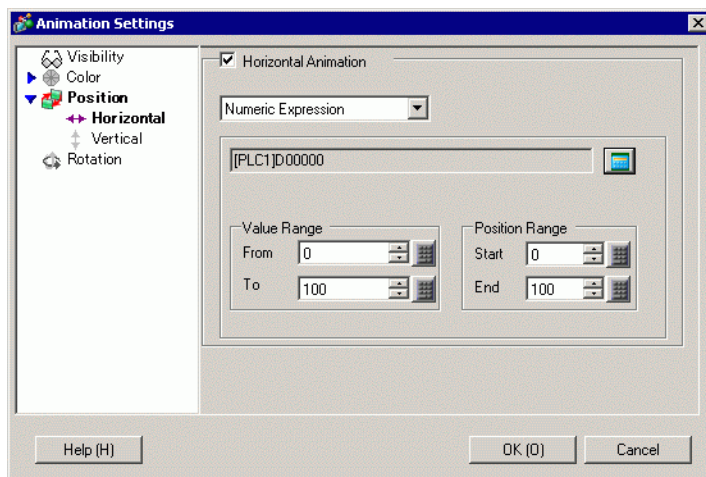

- 3 Select the [Horizontal Animation] check box. Select [Numeric Expression]. Click [] to display the [Bool Expression] dialog box.

4 Select the expression, then set [Address] to D100.

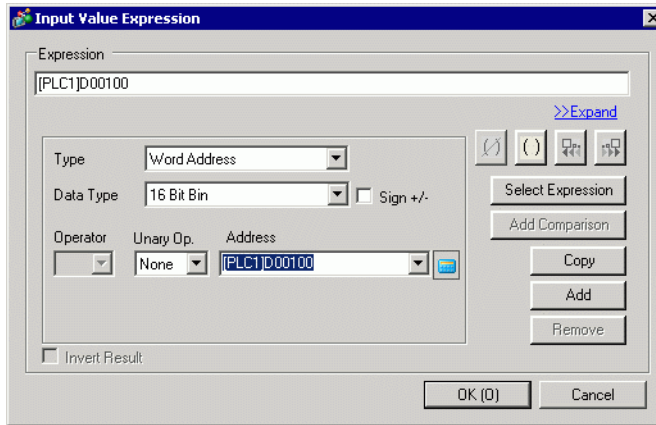

5 When you click [Add], another component is added to the expression. Set its [Address] to D200.

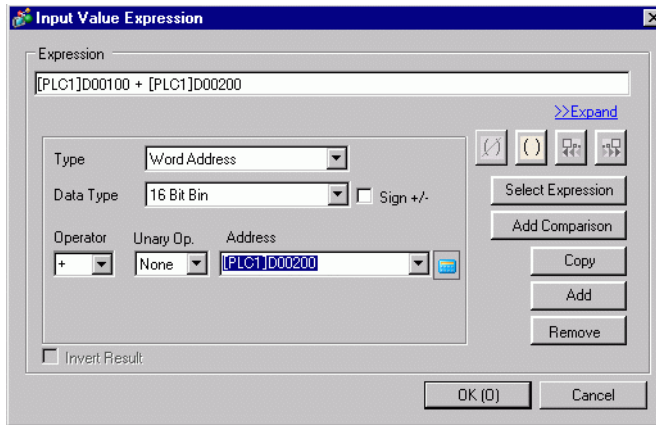

6 Using the mouse, select the entire expression and click **()**.

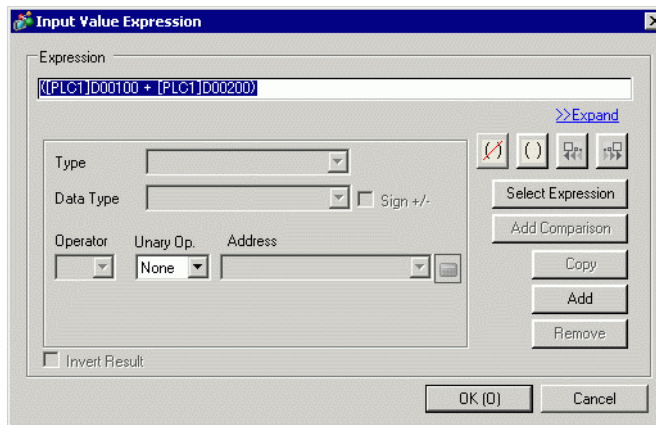

7 Click [Add]. Select the added expression component and set up the following.

Type = Constant

Data Type = Dec

Operator = *

Value = 10

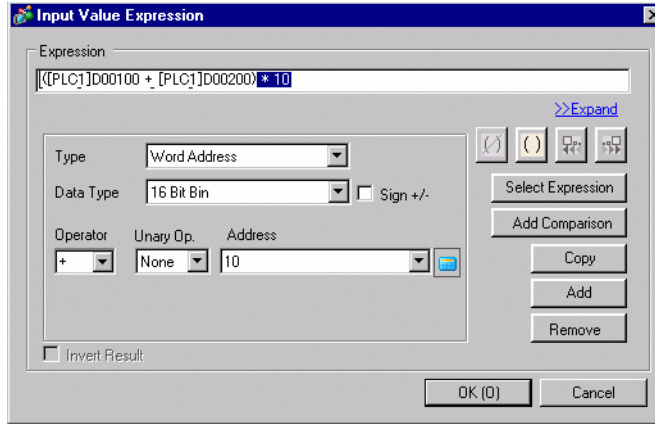



8 Click [OK (O)].

◆ **Bool Expression**

Setting Example: Visibility animation displays object when D100>D200

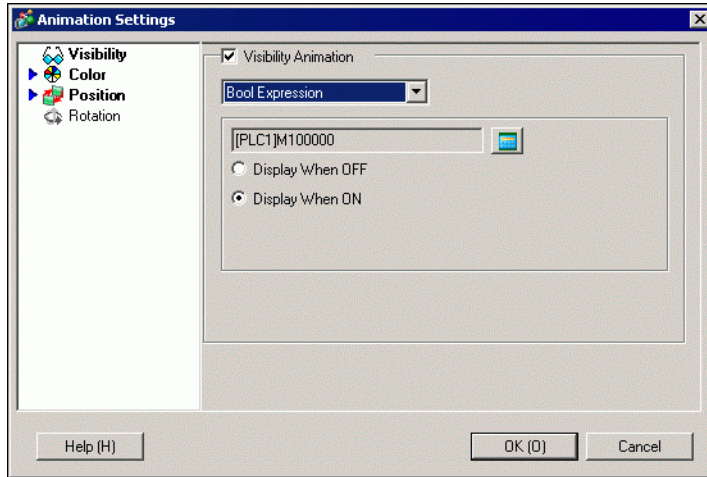
- 1 Select the object you want to show or hide. From the [Edit (E)] menu select [Animation (N)], or right-click the object and select [Animation (N)].
- 2 The [Animation Settings] dialog box appears. On the left pane, select [Visibility Animation].
- 3 Select the [Visibility Animation] check box. Select [Bool Expression] and the [Display When ON] option.



- 4 Click [] to display the [Bool Expression] dialog box.
- 5 Select the expression and click [Add Comparison].

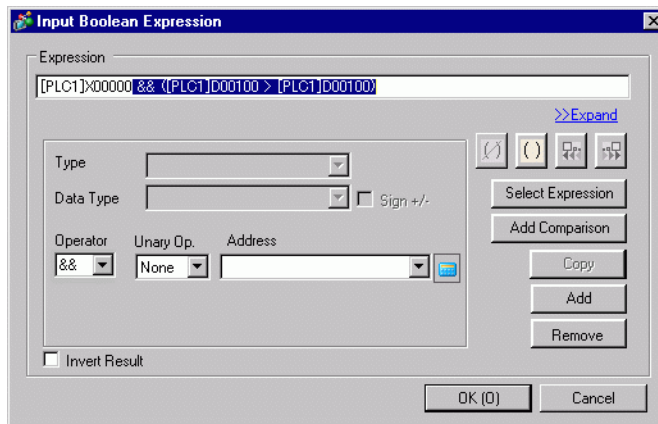

6 Select the unnecessary portion ([PLC1]X0000) and click [Remove].

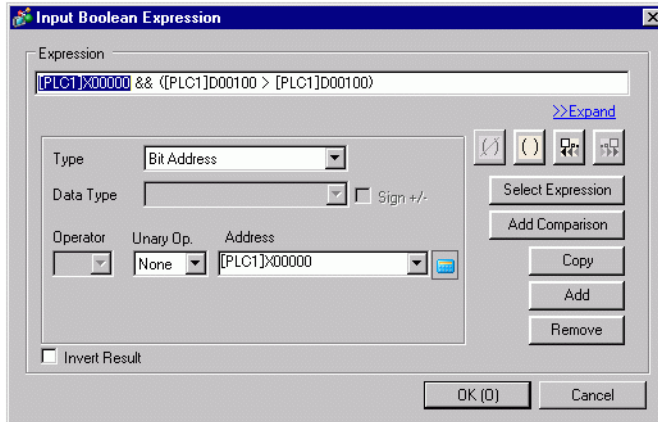

7 Select the address on the left side of the expression and change its [Address] to D100. Similarly, select the address on the right side of the expression and change its [Address] to D200. Also set the [Operator] to >.

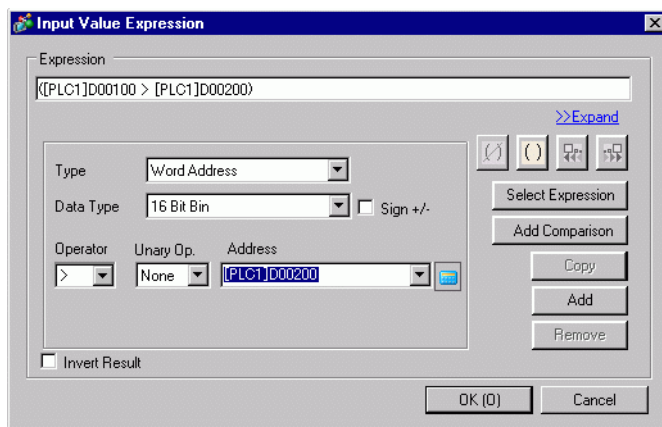

8 Click OK.

◆ Operators: Order of Precedence

| Type | Operator | Precedence Level |
|-------------------------------------|-----------|---|
| Parentheses | () | <div style="text-align: center;"> High  Low </div> |
| Unary Operator | ! ~ - | |
| Multiplication/ Division/Modulus | * / % | |
| Addition/ Subtraction | + - | |
| Shift | << >> | |
| Comparison | < <= > >= | |
| Equality | == != | |
| Bitwise AND | & | |
| Bitwise XOR | ^ | |
| Bitwise OR | | |
| Logical AND | && | |
| Logical OR | | |

For example, $A \gg B + C$
 After calculating $B + C$, right shift A by the $B + C$ value.

NOTE

- When using a comparison operator, the value on the right-hand side of the comparison can range between 0 and 63.
- When using the modulus operator, the values on the right and left-hand sides of the operator can range between 1 and 9223372036854775807.

20.7.2 [Project Information] [File Information] [Expert Mode] Settings Guide

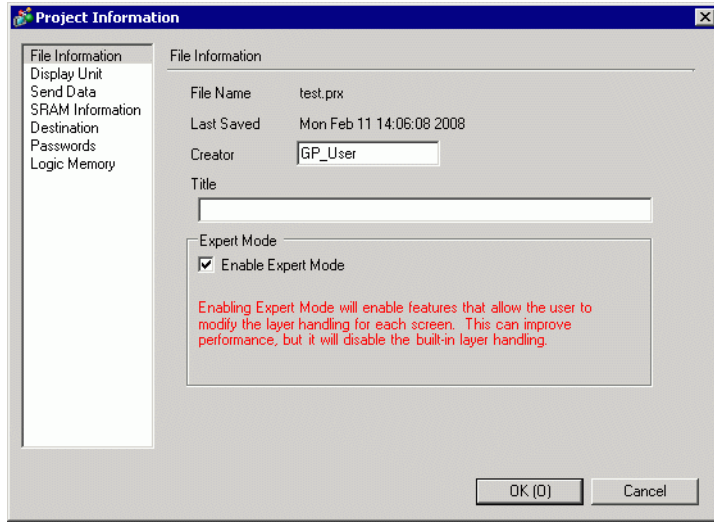

| Setting | Description |
|--------------------|---|
| Enable Expert Mode | <p>When selected, you can change the position of the layer separator - the interface between the base layer and front layer. An example use could be to add animation on the base layer of an object when the display speed is slow because of too many objects on the front layer.</p> <p>NOTE</p> <ul style="list-style-type: none"> • If you return the screen to normal mode after editing in Expert Mode, the layer separator position is reset and any changes will be lost. • Adding animation to the base layer could cause a different display order between the display unit and screen editor. • Refer to the following for details on how to edit in Expert Mode. |

■ Editing in Expert Mode

Follow the steps below to edit in Expert Mode.

- 1 From the [Project] menu, point to [Information] and then click [Project Information]. Select [File Information], and in the [Expert Mode] area select the [Enable Expert Mode] check box.

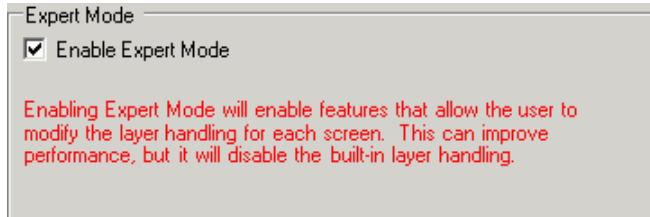

- 2 From the [View (V)] menu, point to [Work Space (W)] and click [Properties (P)]. Select the Base Screen. In the [Properties] dialog box, expand [Background Image] and set [Adjust Layer] to [Advanced].

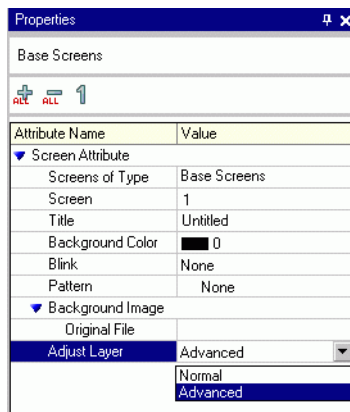

- 3 From the [View (V)] menu, point to [Work Space (W)] and click [Screen Data List (L)]. The layer separator is displayed between the base layer and front layer objects.

You can change the position of the layer separator with the arrow buttons in the bottom-right corner of the dialog box.

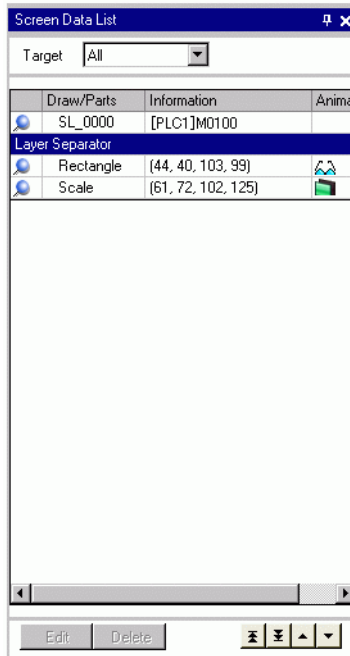

NOTE

- When animation is run on the base layer, the object set up with animation is hidden, including all or part of any other objects in the selection area (rectangular area on the screen editor when the object is selected).

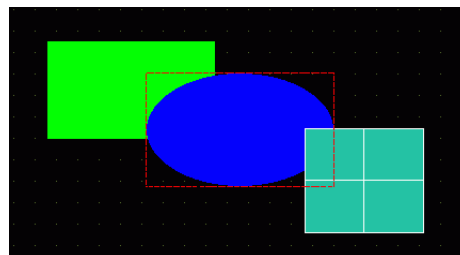

Animation: when hiding the blue oval...

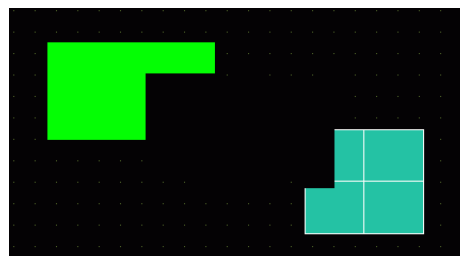

All drawings in the selection area (rectangular area enclosed in a red dashed line).

- On the base layer, if a Show Limit Value part goes into its display state, the rectangular area of the numeric portion returns to the screen.

■ About the Layer Separator

The base and front layers are generated to separate objects in the drawing order, from the first part or drawing set up with animation, and the rest of the parts and drawings. Objects in the front layer display overtop objects in the base layer.

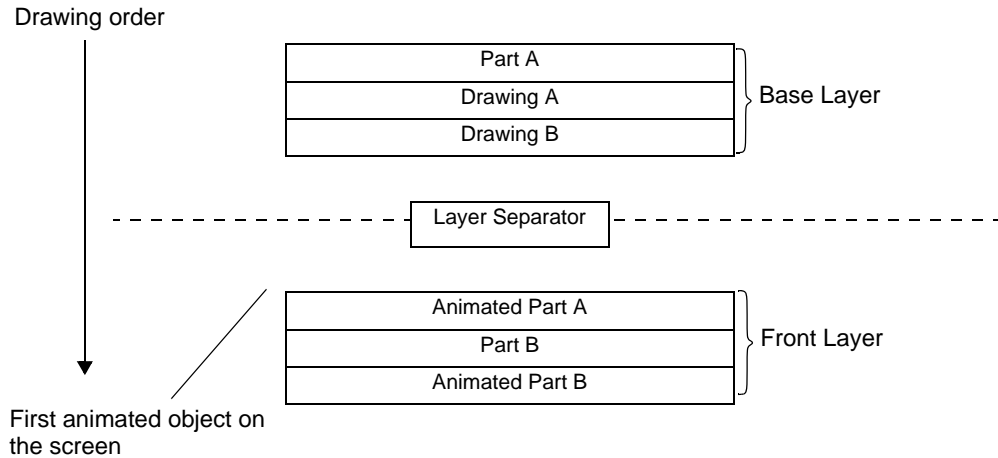

NOTE

- Objects that do not support animation cannot exist in the front layer; therefore these objects, regardless of the drawing order, are placed in the base layer.
- Too many objects in the front layer may reduce the speed of the display's redrawing speed.
- See the following for information on changing the position of the layer separator to improve the display's redrawing speed.
 ☞ "20.7.2 [Project Information] [File Information] [Expert Mode] Settings Guide" (page 20-47)
- When a switch is set up with [Reverse Display] and animation, there is slight delay for it to reverse.
- If objects overlap each other on the front layer, or an object on the front layer overlaps an object on the base layer, Reverse Display does not occur when you touch the overlapped portion.
- If there is a layer separator for loaded parts, the separator is applied at the first layer separator in the drawing order, including called screens.
- D-scripts or Trigger Actions set up on the front layer and on screens called-in execute after the last part on the base layer.
- When Data Display (Numeric Display, Text Display, Date/Time Display), Graph, Historical Trend Graph, Data Block Display Graph, and Switch Lamp parts are drawn overlapping each other, and Animation is added to an object on the base layer, right after changing screens the non-animated objects appear behind the animated object.

20.8 Restrictions

- Animation cannot be added to Window screens of GP3200 and ST3000 series models.
- When a switch is set up with [Reverse Display] and animation, there is slight delay for it to reverse.
- The following differences exist between animation expression operations and D-Script. As a result, calculation results may be different even though you use the same formula.
 - Shift operations are an arithmetic shift.
 - Logical OR and logical AND in BCD are calculated after a binary conversion.
 - The order of precedence for operators is &, ^, |, &&, and then ||.
 - The expression is calculated with 64-bit values (-9223372036854775808 to 9223372036854775807), whereas the calculation results are displayed with 32-bit values (-2147483648 to 2147483647). If the calculation exceeds 64-bit values, or the result exceeds 32-bit values, the results will not display properly. If the calculation result of the expression is outside a 32-bit value range, the animation operation is handled as follows.
 - Less than 32-bit signed range (less than -2147483648)
-> Results in the minimum value of the 32-bit signed range (-2147483648).
 - More than 32-bit signed range (more than 2147483647)
-> Results in the maximum value of the 32-bit signed range (2147483647).
- When Rotation is added to a curved object, it may appear less rounded on the display unit than on the screen editor.
- If objects overlap each other on the front layer, or an object on the front layer overlaps an object on the base layer, Reverse Display does not occur when you touch the overlapped portion.
- Even if a window display switch is hidden, its associated popup window will continue to display.
- Even if an alarm part is hidden, its associated Sub-Display Screen will continue to display.
- When an alarm is hidden while the alarm is in Freeze Mode, Freeze Mode cannot be removed.
- When a historical trend graph is hidden while displaying historical data, you cannot exit the historical data display.

- When you use a Data Display with a clear plate color on the base layer, upon updating its display data, the rectangular data area becomes filled by the background color.

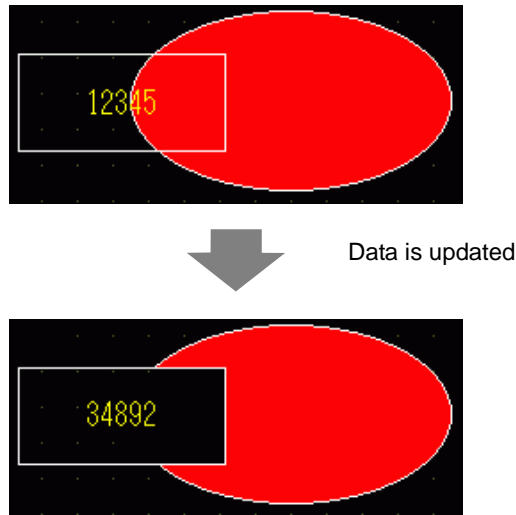

- When a Picture Display's moving Mark overlaps with an animated part on the base layer, a portion of the animated part may remain displayed.
- Animation cannot be added to an object when it uses a shadow. As well, you cannot add a shadow to an animated object. However, you can add animation to a group that contains an object set up with a shadow, and the shadow also becomes animated.
- When you add animation to a group that has shadow objects on the base layer, the rectangular drawing area of a part can erase the shadow. When using color animation and parts are set up without a frame, the shadow may appear in front of the part.
- When a Picture Display's moving Mark overlaps with an animated part on the base layer, a portion of the animated part may remain displayed.