

24



Setting Recipes

This chapter explains how to use recipes in GP-Pro EX and the basic functions used for Recipes.

Please start by reading "24.1 Recipes" (page 24-2) and then turn to the corresponding page.

24.1	Recipes	24-2
24.2	Settings Menu	24-6
24.3	Creating CSV Data Recipes.....	24-10
24.4	Transferring CSV Data Recipes Using Touch	24-18
24.5	Transferring CSV Data Recipes from the Device.....	24-26
24.6	Displaying/Editing CSV data on the Screen.....	24-31
24.7	Creating Filing Data Recipes	24-43
24.8	Transferring Recipes (Filing Data) Using Manual Transfer	24-47
24.9	Transferring Recipes (Filing Data) Using Automatic Transfer	24-53
24.10	Settings Guide.....	24-57
24.11	Mechanism of Transfer CSV Data Setup	24-91
24.12	Mechanism of Filing Data Transfer	24-109
24.13	Restrictions	24-117

24.1 Recipes

24.1.1 What are Recipes?

This feature is used to create recipes with preset data to write to the device/PLC. You can rewrite large numbers of data in the device/PLC by transferring the Recipe data. These recipes can be used in process and production control to specify settings for machine operation (material quantities, heat settings, etc.)

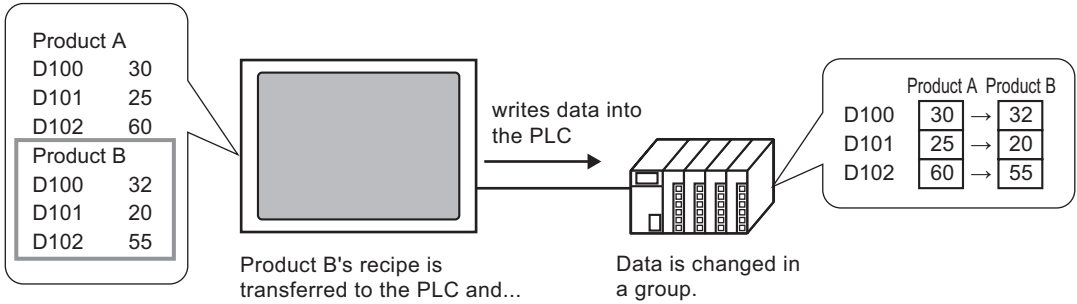

Also, you can read device/PLC data and register it as a new recipe.

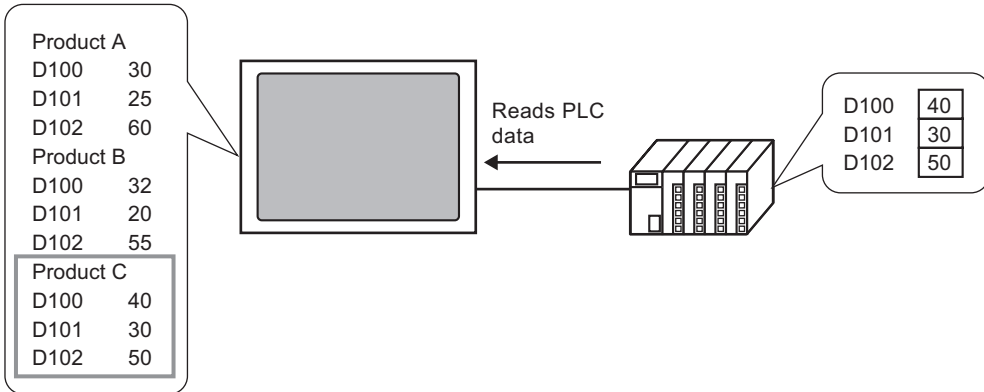

24.1.2 Types of Recipes

There are two types of Recipes: CSV Data and Filing Data.

Transfer CSV Data

CSV Data Recipes are created in Microsoft Excel or in the GP-Pro EX and transferred to the device/PLC using a CF Card.

Write the CSV data saved on the CF Card or USB storage device to the device/PLC, read the device/PLC data, and then save the data on the CF Card or USB storage device as a CSV file.

NOTE

- The [CSV Data Transfer Function] is suitable for creating standardized data and dividing files into recipes.

Transfer Filing Data

Recipe data (binary data) created in GP-Pro EX is called "Filing Data".

These recipes write data from the backup SRAM to the device/PLC, and stores data from the device/PLC to backup SRAM.

Attributes of CSV data and filing data

Recipe Data	Attribute
CSV Data	<ul style="list-style-type: none"> • Transfer the data directly between a CF Card or USB storage device and the device/PLC. • Display on the display unit screen to edit and print the data on the CF Card or USB storage device. • Can be created and edited in spreadsheet software (e.g., Microsoft Excel). • One recipe must be handled as one CSV file.
Filing Data	<ul style="list-style-type: none"> • Keep the recipe in the display unit as internal data without using a CF Card or USB storage device. • You cannot display or edit data on the display unit screen. • By transferring data via the display unit internal device, you can display and edit data on the screen. • Multiple recipes, transferred to the same address, can be handled as a single file.

■ CSV Data Flow

You can transfer CSV data from the CF Card or USB storage device and the device/PLC.

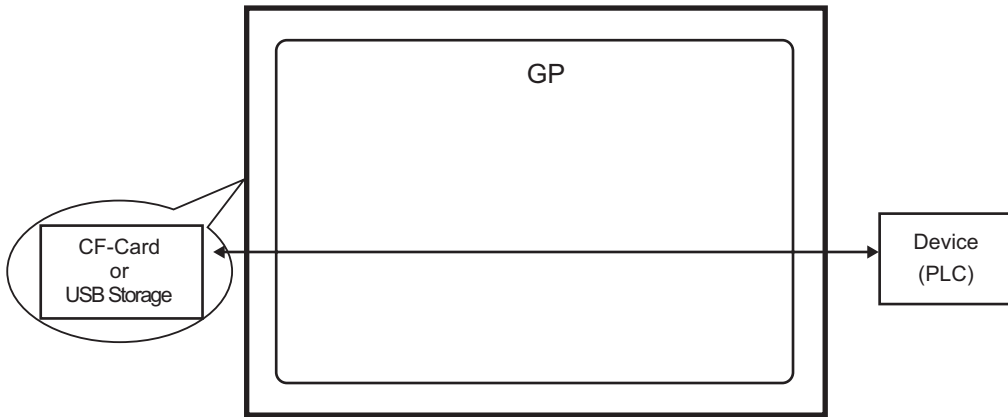

There are two methods for transferring CSV data: control the transfer from the device/PLC (Automatic Transfer), or control the transfer by touching the GP screen (Manual Transfer).

Transfer Methods

Automatic transfer	Set the control address. Each time the bit is turned ON by the device, the data is transferred. The transfer action can be set as Condition Action or Address Action.	
	Condition Action	Transfer according to a previously set condition. NOTE • By using the Condition Name Search feature, only data that corresponds with the designated condition name is transferred.
	Address Action	The address is set at the time of transfer. The destination address for the transfer can be changed when the transfer is made.
Manual transfer	Place a Special Data Display [Data Transmission] on the screen, select the file to transfer, and touch the transfer switch. Data is then transferred.	

■ Filing Data Flow

Filing data created in GP-Pro EX is transferred to the display unit's internal memory or the CF Card by screen transfer. In order to transfer data to the PLC, you need to first write data to backup SRAM. This is called "Transfer Preparation".

After transfer preparation, filing data is transferred between backup SRAM and the device/PLC.

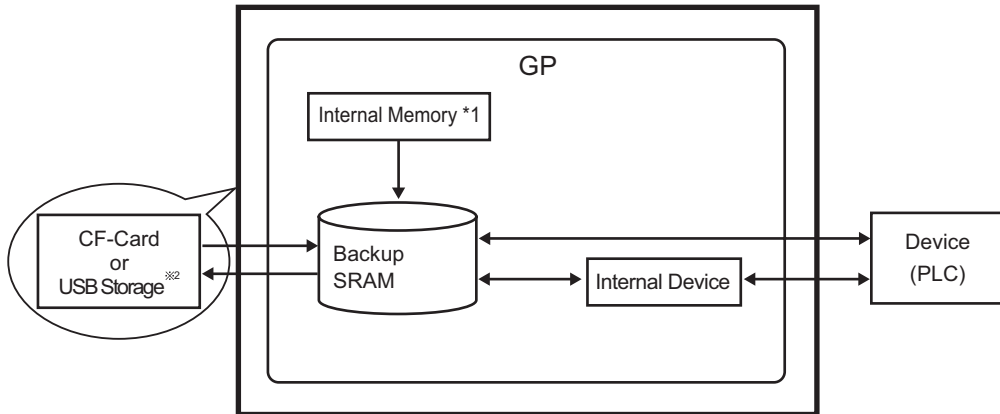

*1 Memory where the screen data is stored. Filing data is stored in memory via a screen transfer.

*2 Transfer Project cannot transfer the data in USB Storage Destination Folder to the USB storage device inserted in the display unit. Copy the data in the folder to the USB storage device manually, and store the USB storage device on the display unit.

IMPORTANT

- Filing data in backup SRAM can not be edited on the display unit. It can only be edited in GP-Pro EX. To edit data on the display unit, transfer it via the display unit's internal device, and use Data Display to edit the data stored in the internal device.

There are two methods for transferring Filing data: control the transfer from the device/PLC (Automatic Transfer), or control the transfer by touching the GP screen (Manual Transfer).

Transfer Methods

Automatic transfer	Set the control address and transfers data when the PLC trigger bit turns ON.
Manual transfer	Place a Special Data Display [Filing] on the screen, select the data (block) to transfer, and touch the transfer switch. Data then transfers.

24.2 Settings Menu

Creating CSV Data Recipes

Create a recipe as a CSV file with Microsoft Excel or GP-Pro EX.

ZR00000.csv	ZR00001.csv
350	400
5	8
7	8
12	16
245	310
12	40

- ☞ Setup Procedure(page 24-11)
- ☞ Details(page 24-10)

Transferring CSV Data Recipes Using Touch

Touch the Special Data Display [Data Transmission] transfer switch on the screen and transfer the selected CSV data.

ZR00000.csv	Write CSV data to the PLC	PLC Data
350		D100 350
5		D101 5
7		D102 7

- ☞ Setup Procedure(page 24-19)
- ☞ Details(page 24-18)

Transferring CSV Data Recipes from the Device

Transfer CSV data by turning ON a designated control address.

- ☞ Setup Procedure(page 24-27)
- ☞ Details(page 24-26)

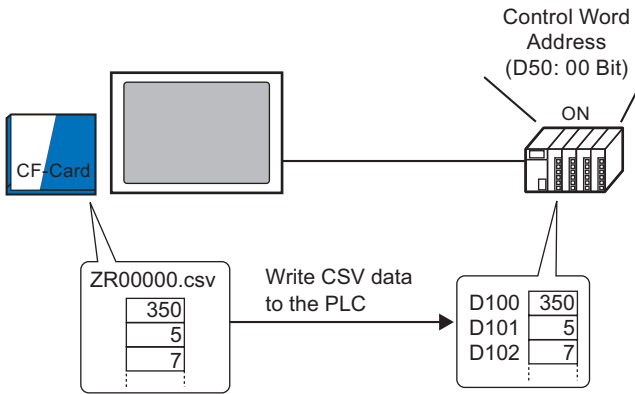

Displaying/Editing CSV data on the Screen

Display the CSV data on the CF Card or USB storage device on the special data display [CSV display].

- ☞ Setup Procedure(page 24-32)
- ☞ Details(page 24-31)

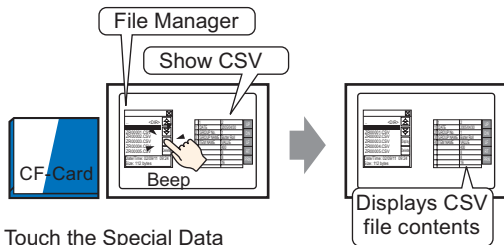

Touch the Special Data Display [File Manager]'s display switch and...

Edit the CSV data on the CF Card or USB storage device directly on the screen.

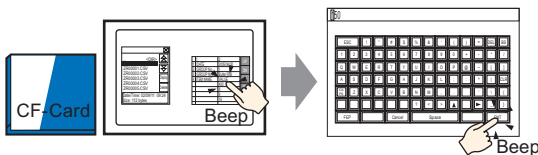

Touch the cell you want to edit on the Special Data Display [Show CSV] and...

The editing screen is displayed

Print CSV data that displays in "Show CSV".

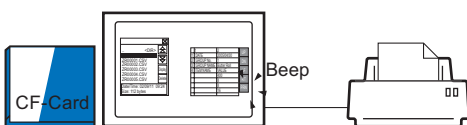

Touch the print switch on the [Show CSV] and...

CSV data is printed.

Creating Filing Data Recipes

Creating a recipe in GP-Pro EX.

Filing Data			
	Block 0	Block 1	Block 2
Item Name	Bread	Butter Roll	Croissant
[PLC1]D00100	350	400	200
[PLC1]D00101	5	8	4
[PLC1]D00102	7	8	3
[PLC1]D00103	12	16	10
[PLC1]D00104	245	310	120
[PLC1]D00105	12	40	10



- ☞ Setup Procedure(page 24-44)
- ☞ Details(page 24-43)

Transferring Recipes (Filing Data) Using Manual Transfer

Touch the Special Data Display [Filing] transfer switch on the screen and transfer the selected recipe.

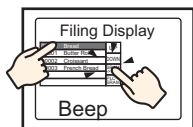

Select the recipe name on the screen and touch the switch to transfer from SRMA → PLC and ...



Backup SRAM

	Block 0	
Item Name	Bread	E
[PLC1]D00100	350	4C
[PLC1]D00101	5	8
[PLC1]D00102	7	8
[PLC1]D00103	12	1E
[PLC1]D00104	245	31

D100	350
D101	5
D102	7
⋮	⋮

Writes the selected block's data to the PLC

- ☞ Setup Procedure(page 24-48)
- ☞ Details(page 24-47)

Transferring Recipes (Filing Data) Using Automatic Transfer

Transfer Filing data by turning ON a designated control address.

- ☞ Setup Procedure(page 24-54)
- ☞ Details(page 24-53)

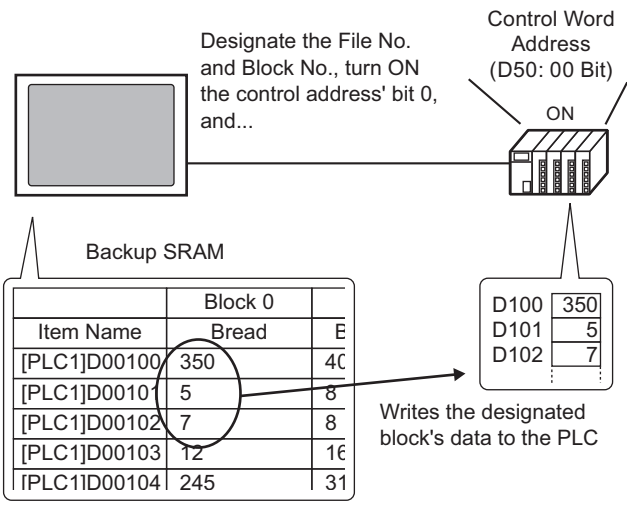

24.3 Creating CSV Data Recipes

24.3.1 Introduction

Create a CSV Data Recipe to write to the CF Card of the device.

There are two methods for creating Recipes: creating a spreadsheet and saving it as a CSV file or creating a recipe in GP-Pro EX.

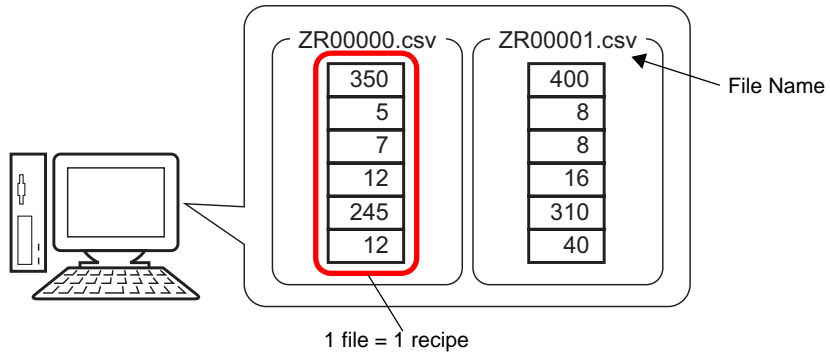

24.3.2 Setup Procedure

■ Creating CSV Data Recipes with Excel

To create a recipe using a spreadsheet, first create the spreadsheet in Microsoft Excel, save it as a CSV file, and then save it to a CF Card or USB storage device.

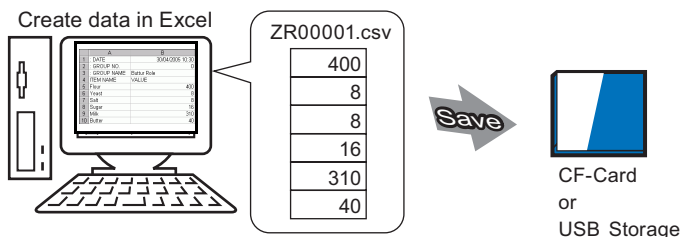

1 Open Microsoft Excel and enter the appropriate values. The values are listed below and display in the image.

The GP transfers the data according to these parameters:

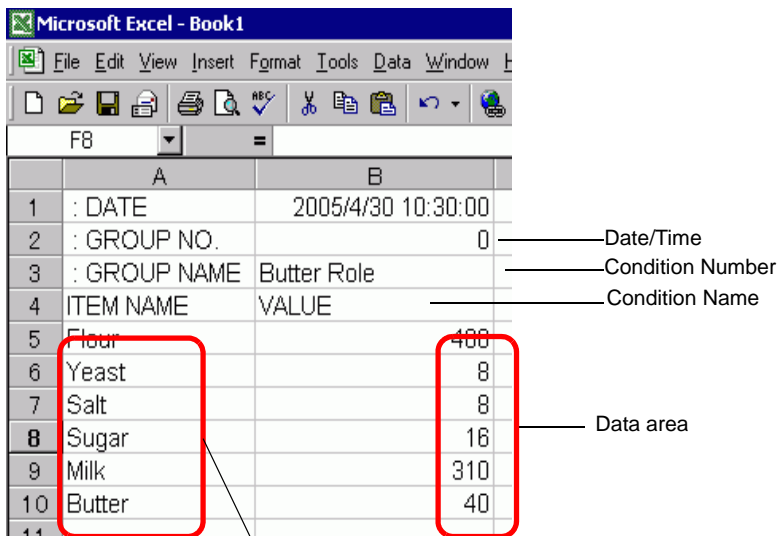

Enter Data Item Names or Transfer Address as needed (These entries will not be transferred to the Device)

: DATE

Enter the data's creation date.

: GROUP NUMBER

Enter the Condition Number to transfer.

: GROUP NAME

Enter an optional Condition Name.

ITEM NAME

You can use the area below the ITEM NAME field to enter comments or additional information as necessary.

VALUE

You can use the area below the ITEM NAME to enter any other information.

NOTE

- Only the data portion will be transferred to the device via Transfer CSV Data. Enter the Condition Number, the Condition Name, and comment as required. When transferring data, regardless of Condition Number and Condition Name, they are transferred according to the conditions set in the [Transfer CSV Data (Condition) (T)]. You can access these from the [Recipe (R)] under [Common Settings (R)].

2 Save the file to the CF Card or the USB storage device.

Specify the destination to save the file in the CF Card or USB storage [FILE] folder.

Select "CSV" for the file. Set the file name to "ZR*****.csv", where ***** is a 5-digit file number from 00000 to 65535.

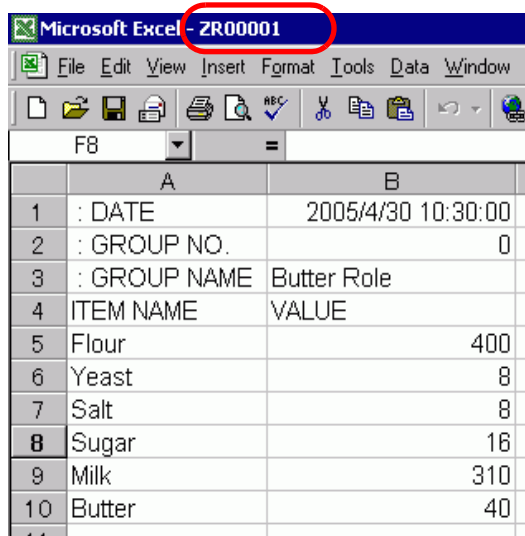

	A	B
1	: DATE	2005/4/30 10:30:00
2	: GROUP NO.	0
3	: GROUP NAME	Butter Role
4	ITEM NAME	VALUE
5	Flour	400
6	Yeast	8
7	Salt	8
8	Sugar	16
9	Milk	310
10	Butter	40

The Recipe is created.

If your computer does not have CF Card drivers, set the CF Card export folder and save. The CF Card output folder data is transferred to the GP's CF Card via a screen transfer.

NOTE

- To select the CF Card Folder in GP-Pro EX, from the [Project (F)] menu, point to [Information (I)] and select [Destination Folder (C)].
 ⏪ "5.7.2 Setup Procedure ■ Setting the Destination Folder" (page 5-46)

◆ **Editing Data in Microsoft Excel**

You can edit and save data transferred from the device/PLC to the CF Card or USB storage device in Microsoft Excel. When opening the CSV file in Microsoft Excel, the following appears:

	A	B
1	:DATE	30/04/2005 10:30:00
2	:GROUP NO.	1
3	:GROUP NAME	Butter Roll
4	ITEM NAME	VALUE
5		400
6		8
7		8
8		16
9		310
10		40

: DATE

Records the date when the file was saved to the CF Card or USB storage device. The date is recorded using a 4-digit year. For example: 2005/04/30.

: GROUP NUMBER

The Condition Number set in the conditional settings is written.

: GROUP NAME

The Condition Name set in the conditional settings is written.

ITEM NAME

The area below this item is blank.

VALUE

The area below this item contains the transferred data.

■ Creating Recipe Data in GP-Pro EX

NOTE

- Please refer to the Settings Guide for details.
 ☞ "24.10.1 Common [Recipe] Setup Guide ■ Transferring CSV Data (CSV File List)" (page 24-62)

Create a recipe in GP-Pro EX then save to a CF Card or USB storage device.

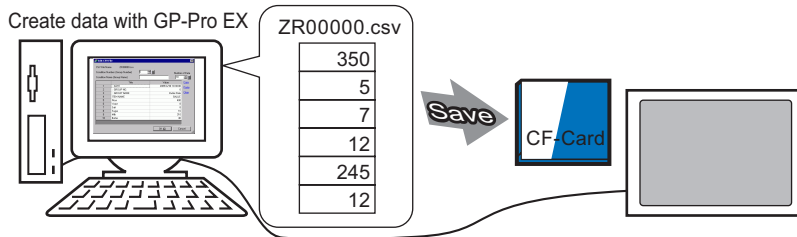

The following procedure explains how to save CSV data on a CF Card or USB storage device.

- 1 From the [Common Settings (R)] menu, point to [Recipe (R)] and select [CSV Data Transmission (CSV File List)(F)]. In [Save In] select [CF Card] or [USB Storage].

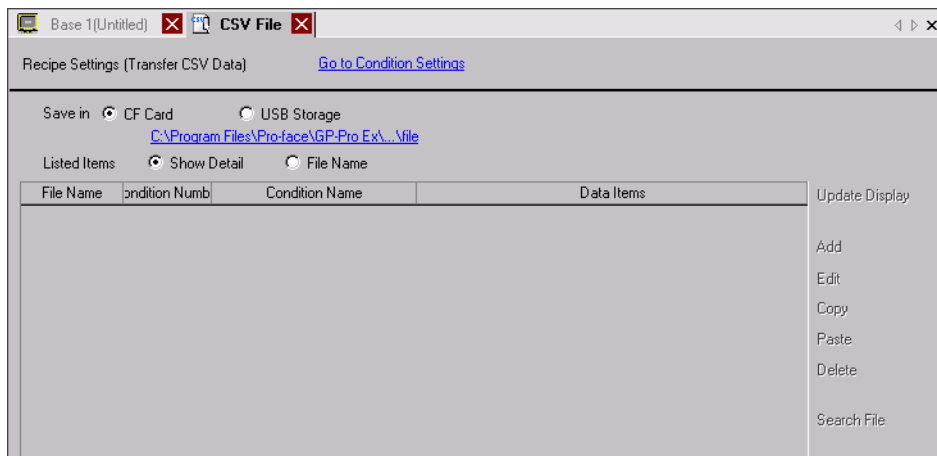

If the CF Card Folder is not yet set, the following message appears. Click [Yes].

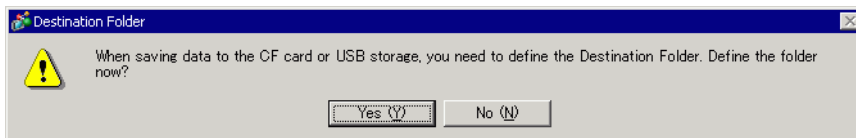

Select the [Enable CF Card] check box. Click [Browse] and set the CF Card Folder. Click [OK].

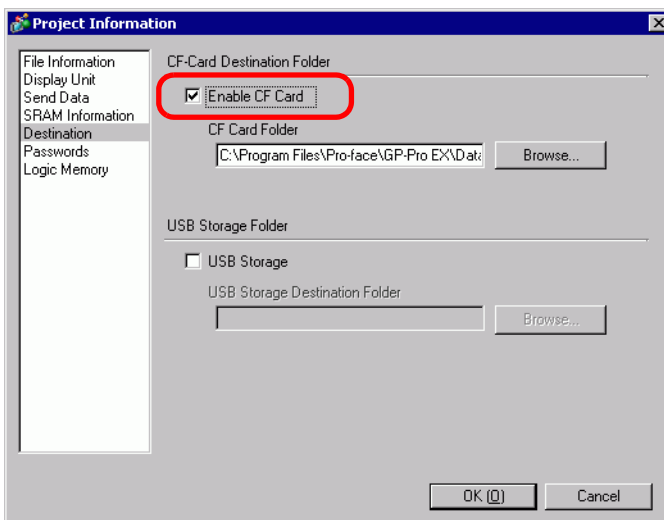

NOTE

- The CF Card Folder is the location where created data is temporarily saved inside the project. The data saved here is saved to the CF Card via a screen transfer.
- The CF Card Folder can be set using this method or set from the Project Properties.
- Specify the USB Storage Destination Folder when you select [Save in] and point to [USB storage]. You cannot use project transfer to move the saved data saved to the display unit's USB storage device. You must manually copy the data to the USB storage device and then connect the device to the display unit.

2 Click [Add]. The [Add CSV File] dialog box appears.

Set the [CSV File Number] and click [OK].

In the file name "ZR****.csv", **** represents the file number portion set here.

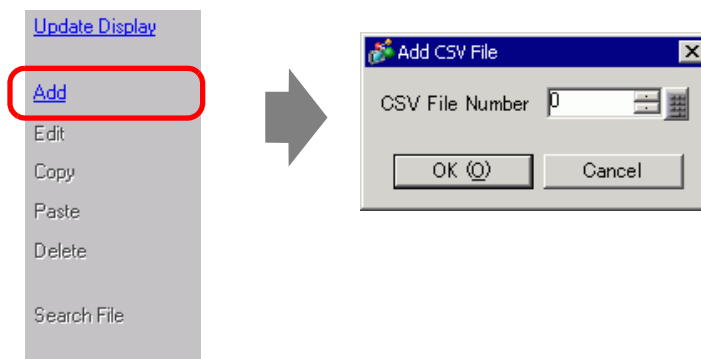

NOTE

- To enable [Add], [Transfer CSV Data] should be selected in the [Recipe (R)] > [Transfer CSV Data (Condition) (T)] tab.
 ☞ "24.4.2 Setup Procedure" (page 24-19)

3 The [Edit CSV File] dialog box appears.

In [Condition Name (Group Name)], enter the recipe name. Enter each value and title, then click [OK].

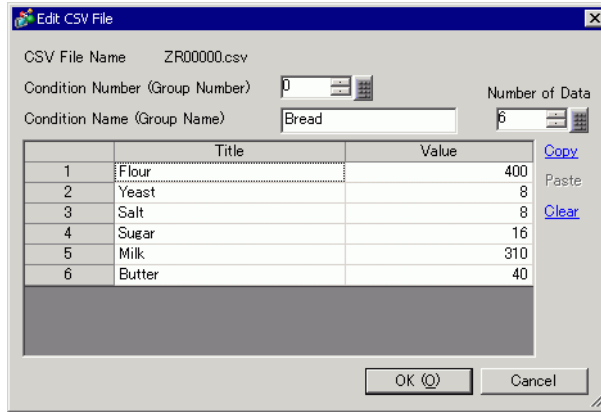

4 The recipe appears in the file list.

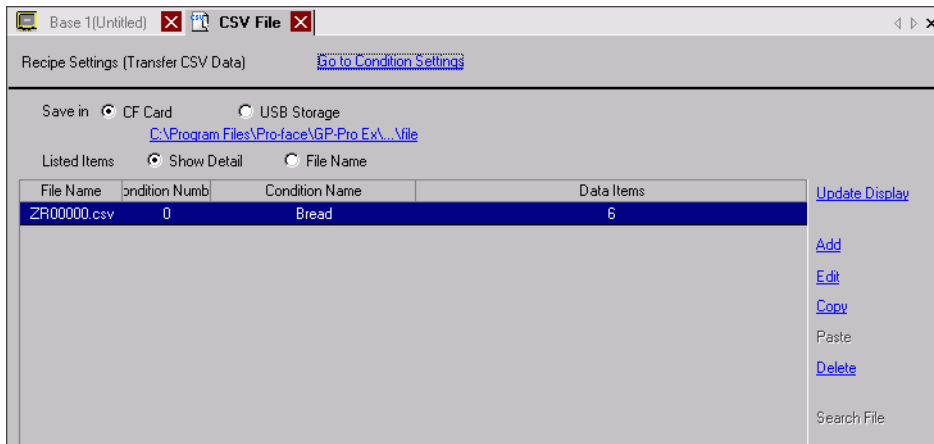

To edit data, select the file and click [Edit].

The recipe is saved in the [FILE] folder in the designated CF Card folder with the following format.

	1st Column	2nd Column	
1st Row	: DATE	(Date Saved)	
2nd Row	: GROUP NUMBER	(Condition Number)	
3rd Row	: GROUP NAME	(Condition Name)	
4th Row	ITEM NAME	VALUE	
5th Row	Flour	350	} Created data
6th Row	Yeast	5	
7th Row	Salt	7	
8th Row	Sugar	12	
9th Line	Milk	245	
10th Row	Butter	12	

- ":DATE", ":GROUP NO", ":GROUP NAME", "ITEM NAME", and "VALUE" are fixed.
- Dates are written in the format "yyyy/mm/dd hh:mm:ss".
- The Condition Number and Condition Name are written.
- Below "ITEM NAME" in the first column, the designated titles are written.
- Below "VALUE" in the second column, the designated values are written.

24.4 Transferring CSV Data Recipes Using Touch

24.4.1 Introduction

The recipe (CSV data) saved on the CF Card or USB storage device displays in a list on the display unit. Touch to select or clear the recipes you want to send to the device/PLC.

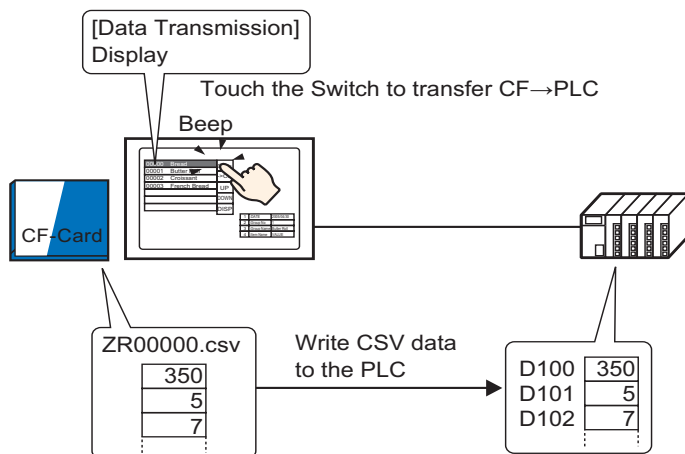

Device/PLC data overwrites the selected files on the CF Card or USB storage device.

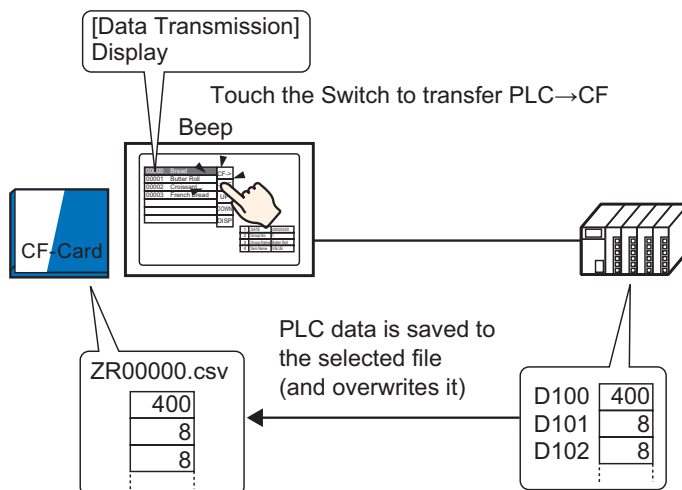

NOTE

- You cannot save data as a new file when you manually transfer from the device/PLC to the CF Card or USB storage device. Data can only be overwritten in the selected file from the Special Data Display [Data Transmission].
- To overwrite existing Device/PLC data in a CSV file, you can select [All Files] or [Overwrite Data Only]. The [Overwrite Data Only] option overwrites dates and values only and leaves other data unchanged.

24.4.2 Setup Procedure

NOTE

- Please refer to the Settings Guide for details.
 - ☞ "24.10.1 Common [Recipe] Setup Guide ■ Transfer CSV Data (Condition)" (page 24-57)
 - ☞ "24.10.2 [Special Data Display] Settings Guide ■ Data Transmission" (page 24-74)
- For details of the part placement method and the address, shape, color, and label setting method, refer to the "Part Editing Procedure".
 - ☞ "8.6.1 Editing Parts" (page 8-52)

On the GP screen's Special Data Display [Data Transmission], set the options for transferring CSV data by touch.

1 From the [Common Settings (R)] menu, point to [Recipe (R)] and select [Transfer CSV Data (Condition) (T)] command, or click  from the toolbar. The following window screen appears.

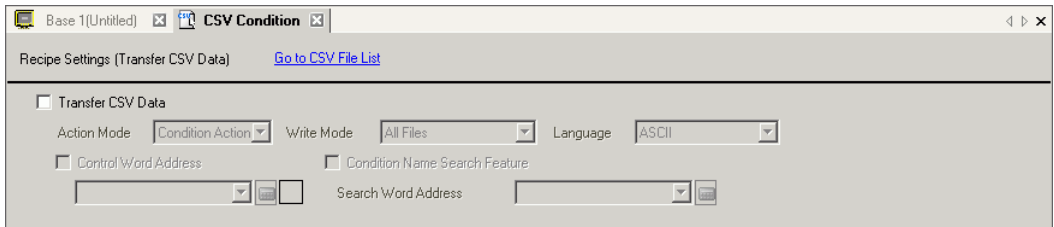

2 Select the [Transfer CSV Data] check box, and define the [Action Mode] as [Condition Action], and [Write Mode] as [All Files].

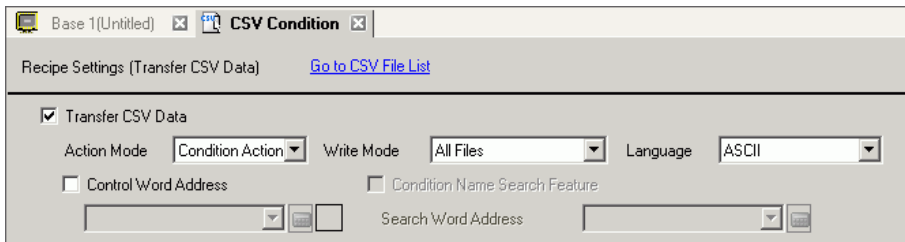

3 In [Condition], click [New]. The [CSV Data Transfer Condition] dialog box appears.

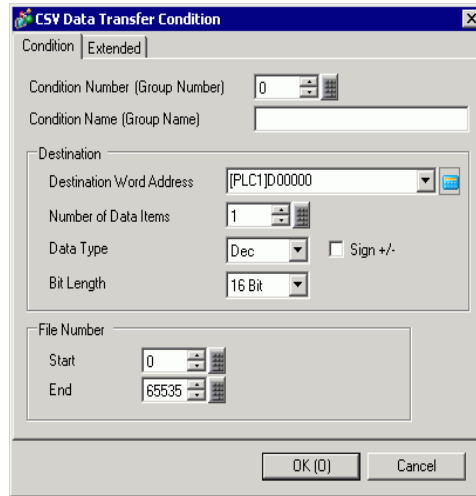

4 Enter the [Condition Number] and [Condition Name].

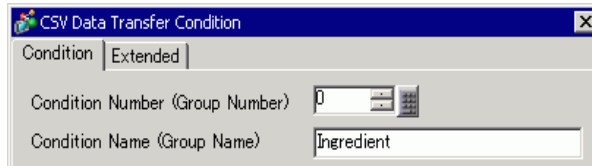

5 In the [Destination Word Address] field, set the start address for the destination device/PLC address (D100) and then set the [Number of Data Items], [Data Type], and [Bit Length].

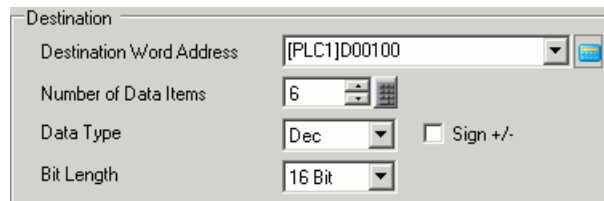

6 Designate the [Start] and [End] of the recipe file.



Files "ZR00000.csv" to "ZR00010.csv" are transferred according to the condition.

7 Click [OK].

The condition appears in the [Condition] list.

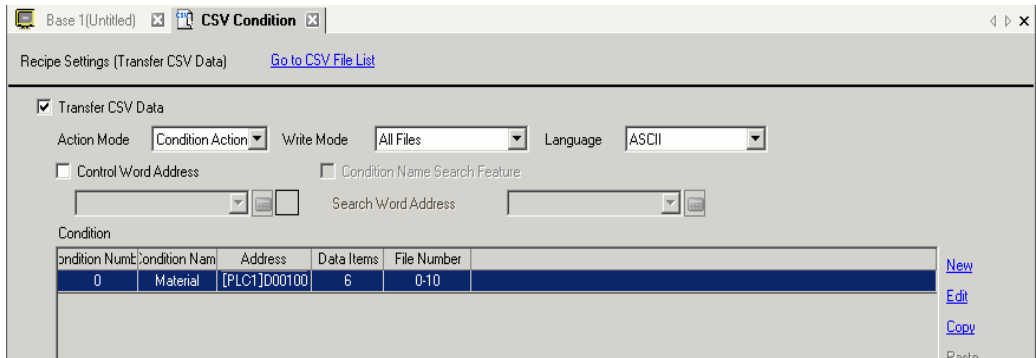

Create as many conditions as required.

8 Go to the screen editor. From the [Parts (P)] menu, point to [Special Data Display (P)] and select [Data Transmission (D)] or click  from the toolbar. Place the Part on the screen.

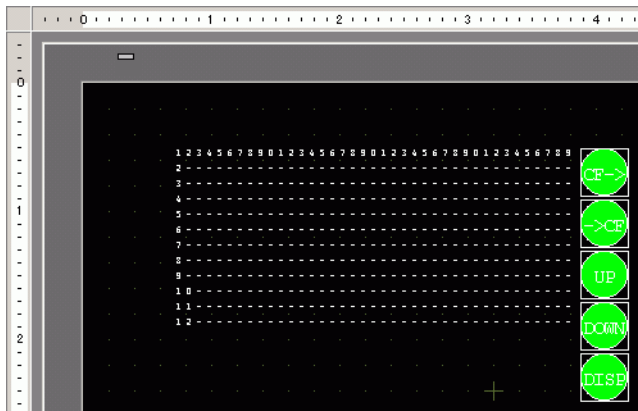

9 Double-click the new Special Data Display. The settings dialog box appears.

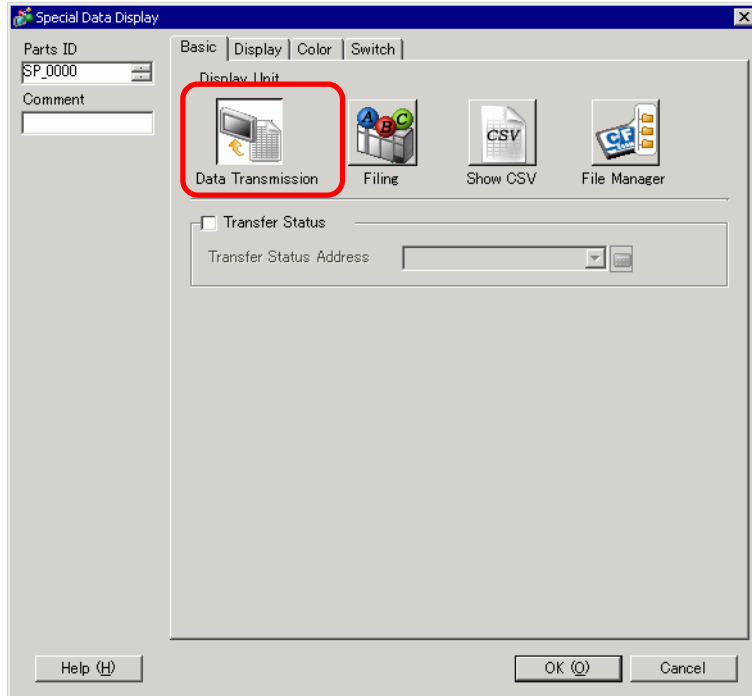

10 Select the [Display] tab. Set the [Font] and [Display Format].

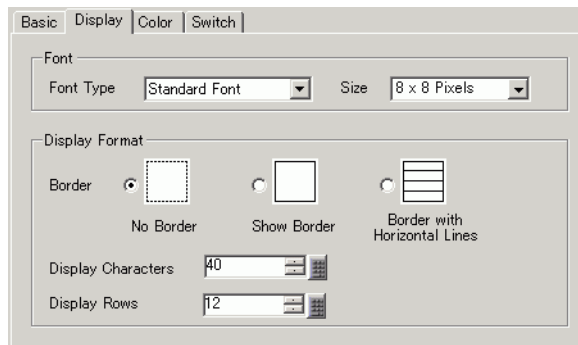

11 Select the [Color] tab and set the text and background color.

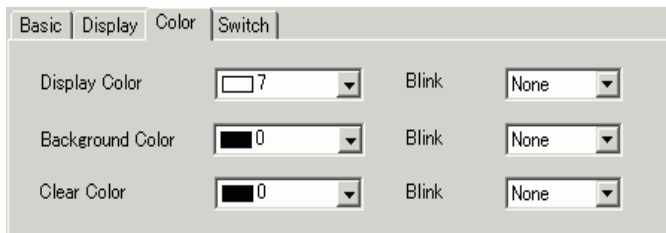

- 12 Select the [Switch] tab and select the operation switches you want to place. Set the number of rows that a scroll switch moves when pressed. Select the shapes, label and text color, and click [OK].

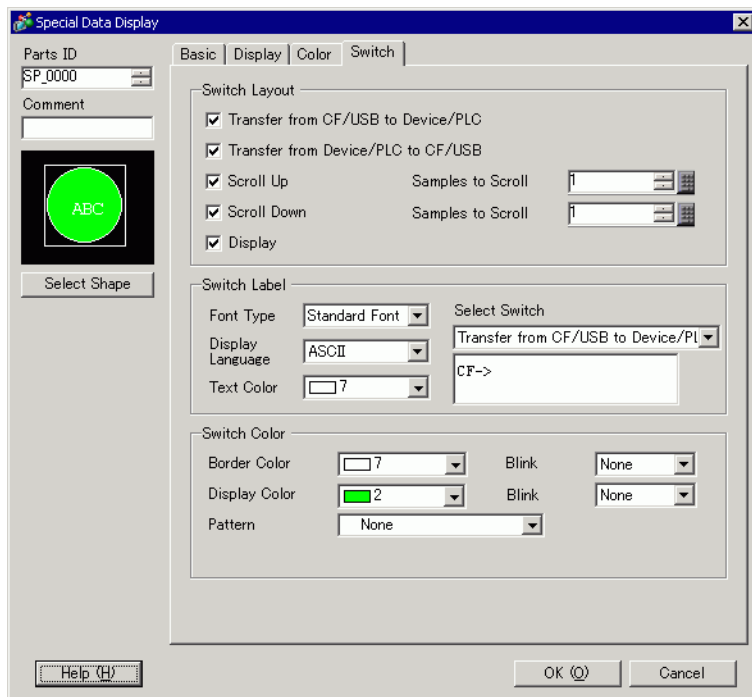

The Special Data Display Part [Data Transmission] is now configured. You can move the switches to the appropriate locations.

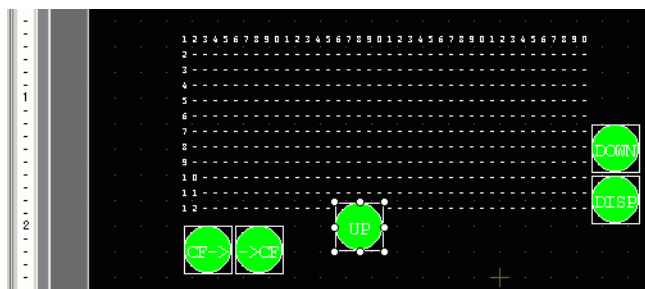

NOTE

- If you want to display CSV data on the GP screen, place a Special Data Display [Show CSV].
 ☞ "24.6 Displaying/Editing CSV data on the Screen" (page 24-31)

24.4.3 Transfer Process

Display the file number from the CF Card or USB storage device and the condition name on the display unit using a Special Data Display [Data Transmission].

- 1 Select the file to transfer by touching it.
You can select multiple files from the displayed list.

NOTE • If you touch a scroll switch while a file is selected, the displayed page changes and the selection cancels. Transfer selected files before you scroll.

- 2 Touch the CF Card/USB→Device/PLC or Device/PLC → CF Card/USB transfer switch. Each file number is transferred according to a previously set condition.

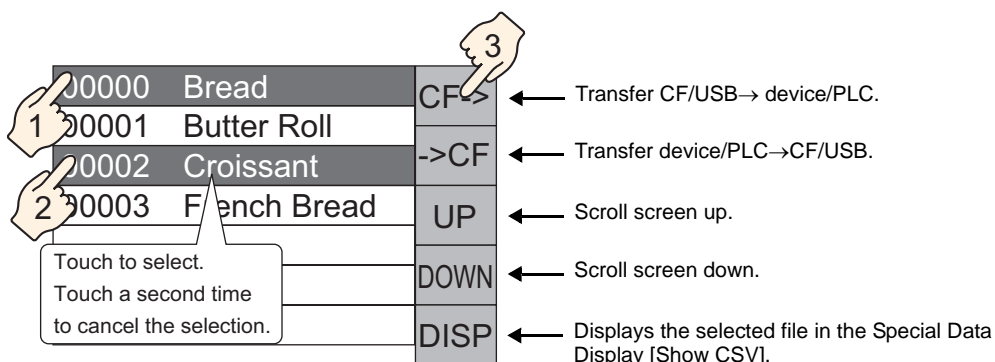

IMPORTANT

- When transferring data from the device/PLC→CF/USB, if Write Mode is set to [All Files], all data on the CF Card or USB Storage will be overwritten. In such cases, the Condition Name of the file is overwritten with the Condition Name defined in the Condition settings.
- If you have selected multiple files, the transfer occurs in order starting with the smallest file number.
- In the Special Data Display [Data Transmission], CSV files appear in the order they were created. You cannot sort by File Number or timestamp.

If both a Special Data Display [Data Transmission] and [Show CSV] are placed on the same screen and you select a file and press the display switch, CSV Data Recipes appear in the [Show CSV].

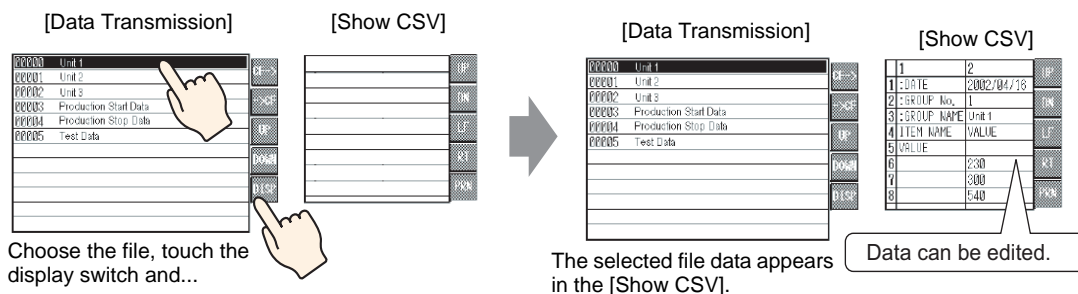

NOTE

- If you select multiple files and touch the display switch, the file with the smallest file number displays.
 - If you set up the Special Data Display [Show CSV] to allow editing of data, you can edit the displayed data by touch. Use this feature when you want to edit CSV data in a CF Card or USB storage on the screen and write to the device/PLC.
 - You can use a Special Data Display [File Manager] and display/edit it in a [Show CSV].
 "24.6 Displaying/Editing CSV data on the Screen" (page 24-31)
-

24.5 Transferring CSV Data Recipes from the Device

24.5.1 Introduction

When bit 0 of the specified control address is ON, the specified CSV data in the CF Card or USB storage device is written to the device/PLC following the preset transfer conditions (such as transfer designation address, number of data).

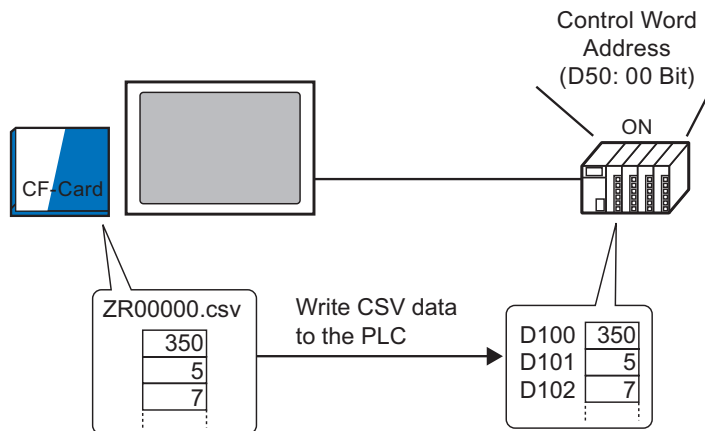

Also, when bit 1 of the Control Address turns ON, the device/PLC data is read and saved to the CF Card or USB storage device as new CSV data according to the previously set transfer conditions (Destination Address, Number of Data Items)

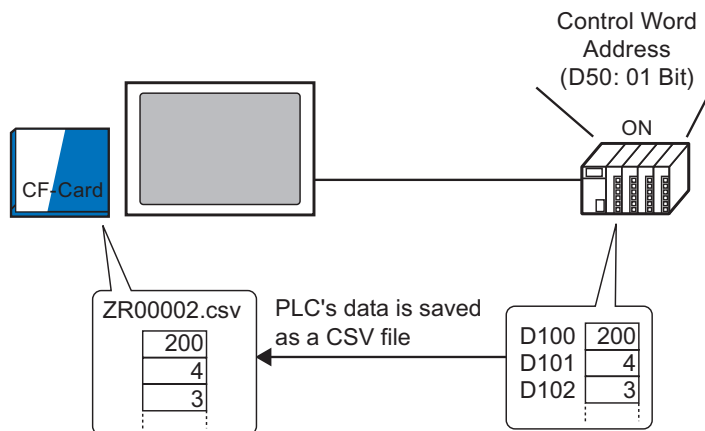

NOTE

- You can transfer multiple files up to a maximum of 64 at one time.
 - You can designate the destination or source address, Number of Data Items, etc., for each file at transfer time.
- ☞ "24.11.2 Control Word Address ◆ For Address Action" (page 24-96)

24.5.2 Setup Procedure

NOTE

- Please refer to the Settings Guide for details.
 "24.10.1 Common [Recipe] Setup Guide ■ Transfer CSV Data (Condition)"
 (page 24-57)

Configure settings so that when the designated address bit 0 turns ON, the specified CSV data is transferred according to the set condition.

- 1 From the [Common Settings (R)] menu, point to [Recipe (R)] and select [Transfer CSV Data (Condition) (T)] command, or click  from the toolbar. The following window screen appears.

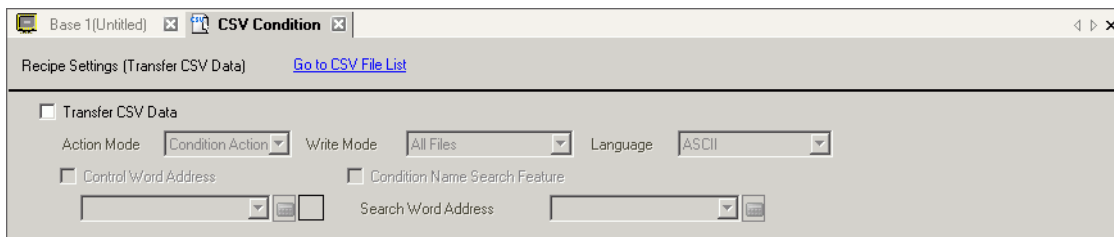

- 2 Select the [Transfer CSV Data] check box, and define the [Action Mode] as [Condition Action], and [Write Mode] as [All Files].

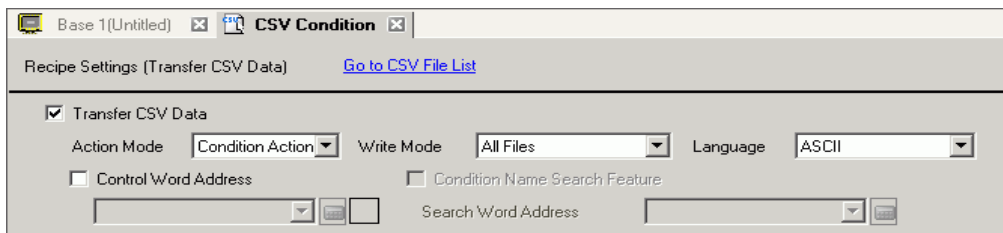

- 3 Select the [Control Word Address] check box and set the address (D50) used to operate the transfer from the device/PLC.

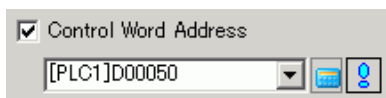

NOTE

- Four consecutive words that include the specified address are used.

4 In [Condition], click [New]. The [CSV Data Transfer Condition] dialog box appears.

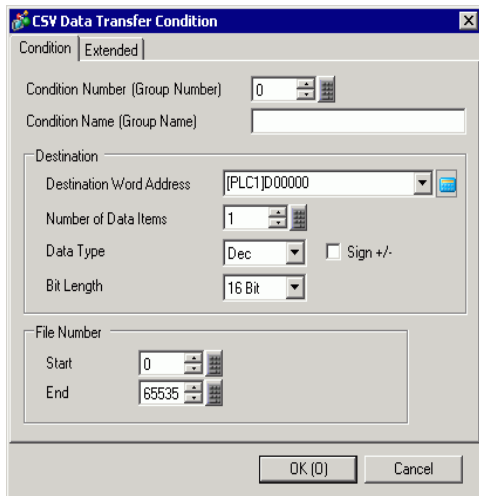

5 Enter the [Condition Number] and [Condition Name].

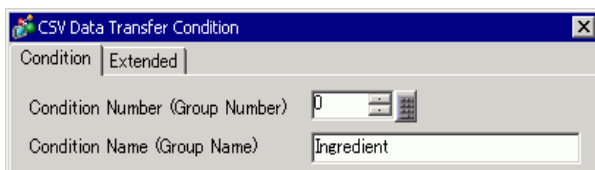

6 In the [Destination Word Address] field, set the start address for the destination device/PLC address (D100) and then set the [Number of Data Items], [Data Type], and [Bit Length].

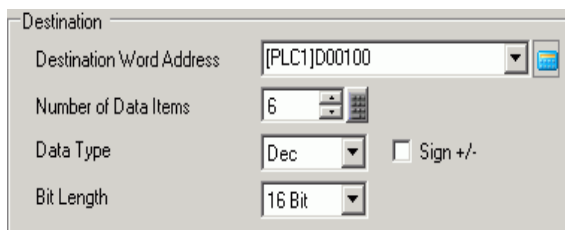

7 Designate the [Start] and [End] of the recipe file.



Files "ZR00000.csv" to "ZR00010.csv" are transferred according to the condition.

8 Click [OK].

The condition appears in the [Condition] list.

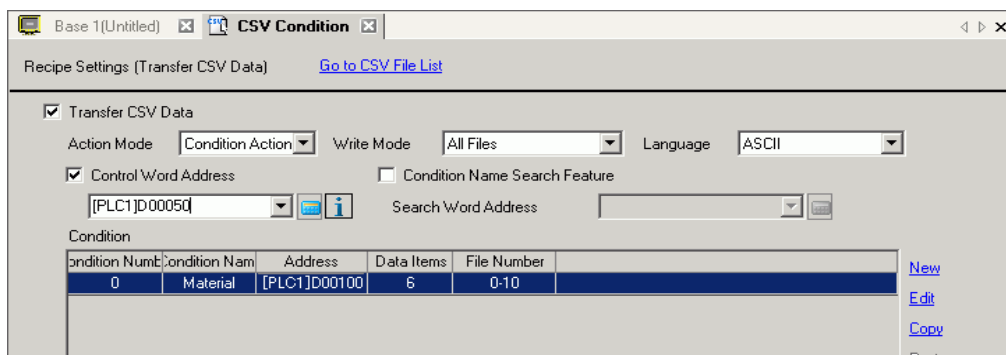

Create as many conditions as required.

NOTE

- If you set the [Condition Name Search Feature] and enter a condition name to search for, the CSV files with that condition name are found and transferred.
 ☞ "24.11.3 About Condition Name Search Feature" (page 24-101)
- When using automatic transfer from device/PLC→CF/USB, you can automatically assign the file numbers and create new CSV files or USB storage.
 ☞ "24.11.4 About Automatic Numbering" (page 24-107)
- To overwrite existing Device/PLC data in a CSV file, you can select [All Files] or [Overwrite Data Only]. The [Overwrite Data Only] option overwrites dates and values only and leaves other data unchanged.

24.5.3 Transfer Process

Transfer CF/USB to Device/PLC

Transfer a single recipe file "ZR00000.csv" to a device/PLC.

D50	Control	
D51	Status	
D52	Number of Files	<- "1"
D53	File Number 1	<- "0"

- 1 In D52, store the number of CSV files to transfer "1".
- 2 In D53, store the File Number "0".
- 3 Turn ON D50's bit 0. According to the settings of Condition Number 0, data transfers into 6 words, D100 to D105.
During the data transfer, D51 (Status address)'s bit 0 (Transferring Bit) turns ON.
- 4 When all files have completed transfer normally, D51's bit 0 turns OFF, and bit 1 (Transfer Complete Flag) turns ON.
Turn OFF D50's bit 0.

Transfer Device/PLC → CF/USB

Save 6 words of data, D100 to D105, to the CF Card as "ZR00002.csv".

D50	Control	
D51	Status	
D52	Number of Files	<- "1"
D53	File Number 1	<- "2"

- 1 In D52, store the number of CSV files to transfer "1".
- 2 In D53, store the File Number "2".
- 3 Turn ON D50's bit 1. According to the settings of Condition Number 0, data from 6 words, D100 to D105, are transferred as "ZR00002".
During the data transfer, D51 (Status address)'s bit 0 (Transferring Bit) turns ON.
- 4 When all files have completed transfer normally, D51's bit 0 turns OFF, and bit 1 (Transfer Complete Flag) turns ON.
Turn OFF D50's bit 1.

24.6 Displaying/Editing CSV data on the Screen

24.6.1 Introduction

You can use a CSV Display or File Manager Special Data Displays to view data on the display unit that is stored on the CF Card or USB storage device.

Displays the CF Card's CSV data on the GP screen.

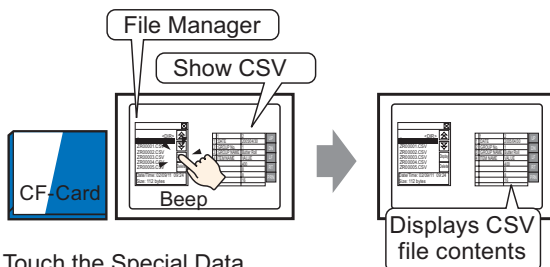

Touch the Special Data Display [File Manager]'s display switch and...

You can edit data that displays on the screen by touching it.

Also, you can print data to a printer that's connected to the GP unit.

Edit CSV data on the screen.

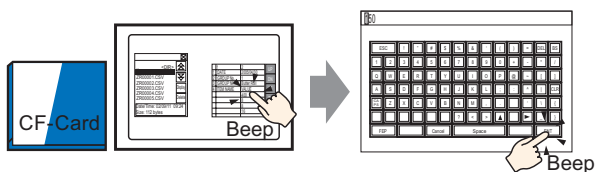

Touch the cell you want to edit on the Special Data Display [Show CSV] and...

The editing screen is displayed

Print CSV data from a printer that's connected to the GP unit.

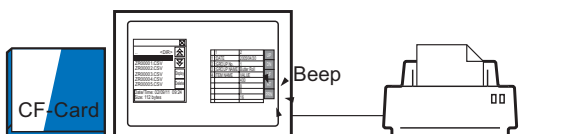

Touch the print switch on the [Show CSV] and...

CSV data is printed.

24.6.2 Setup Procedure

NOTE

- Please refer to the Settings Guide for details.
 - ☞ "24.10.2 [Special Data Display] Settings Guide ■ File Manager" (page 24-88)
 - ☞ "24.10.2 [Special Data Display] Settings Guide ■ CSV Display" (page 24-83)
- For details of the part placement method and the address, shape, color, and label setting method, refer to the "Part Editing Procedure".
 - ☞ "8.6.1 Editing Parts" (page 8-52)

Configures the settings to display, edit, and print CSV data stored on the CF Card.

- 1 From the [Parts (P)] menu, point to [Special Data Display (P)] and select [File Manager (M)]. Place the Part on the screen.

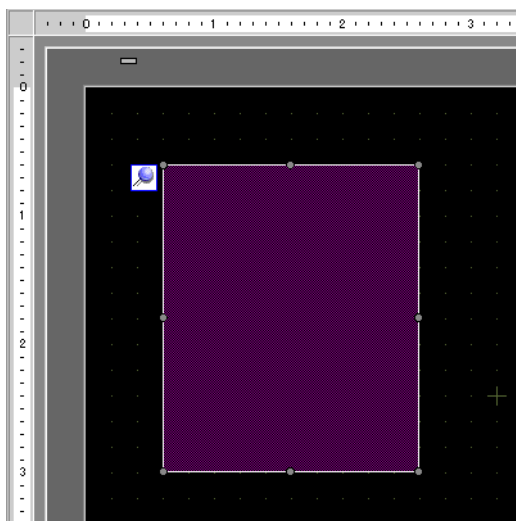

2 Double-click the new Special Data Display [File Manager]. The settings dialog box appears.

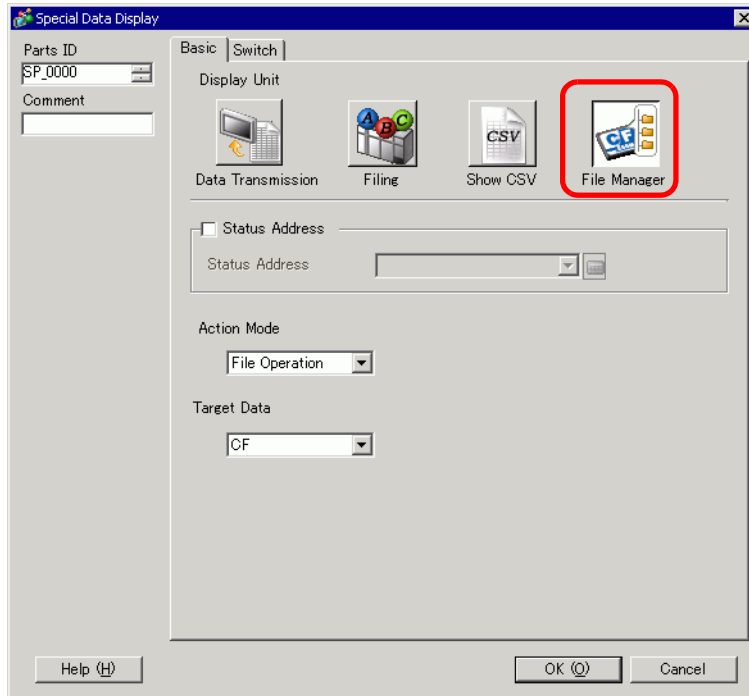

3 In [Action Mode], select [File Operation]. In [Target Data], select [CF].

NOTE • To display the data in a USB storage device, from [Target Data], select [CF <--> USB storage].

4 Click the [Switch] tab. Under [Switch Layout], select the [Display] check box. Select the shape, label and text color. Click [OK].

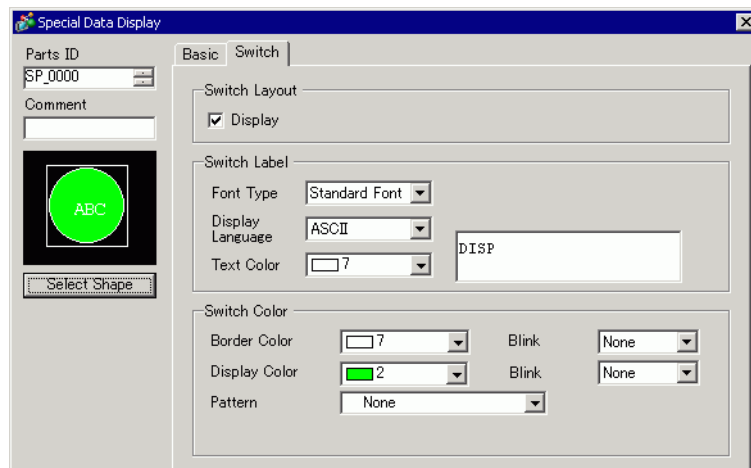

5 Special Data Display Part [File Manager] is now configured. You can move the switches to the appropriate locations.

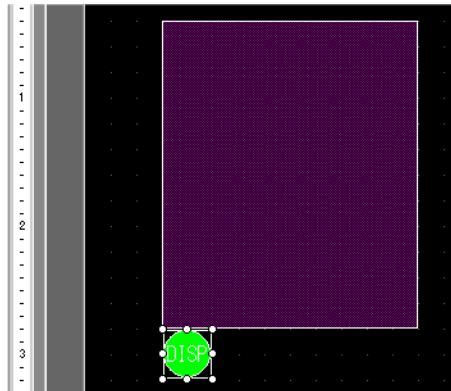

6 On the same screen as the [File Manager], from the [Parts (P)] menu, point to [Special Data Display (P)] and select [Show CSV (C)]. Place the [Show CSV] on the screen.

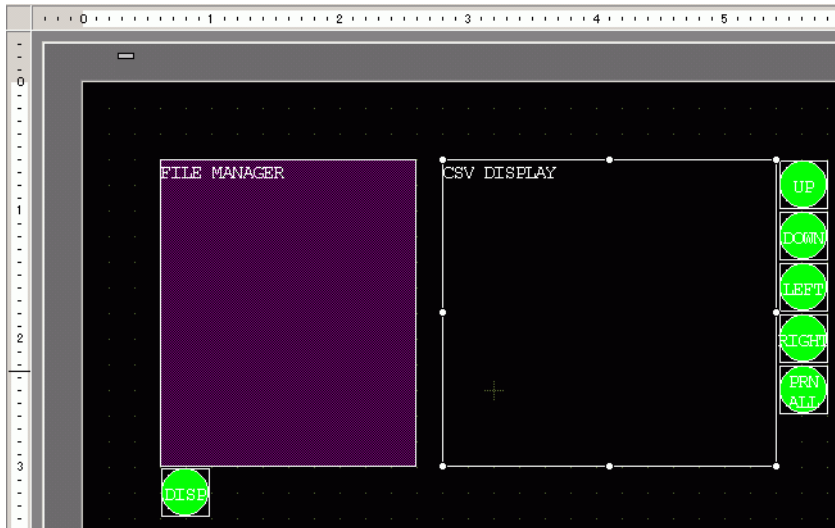

7 Double-click the placed Special Data Display [Show CSV]. The following dialog box appears.

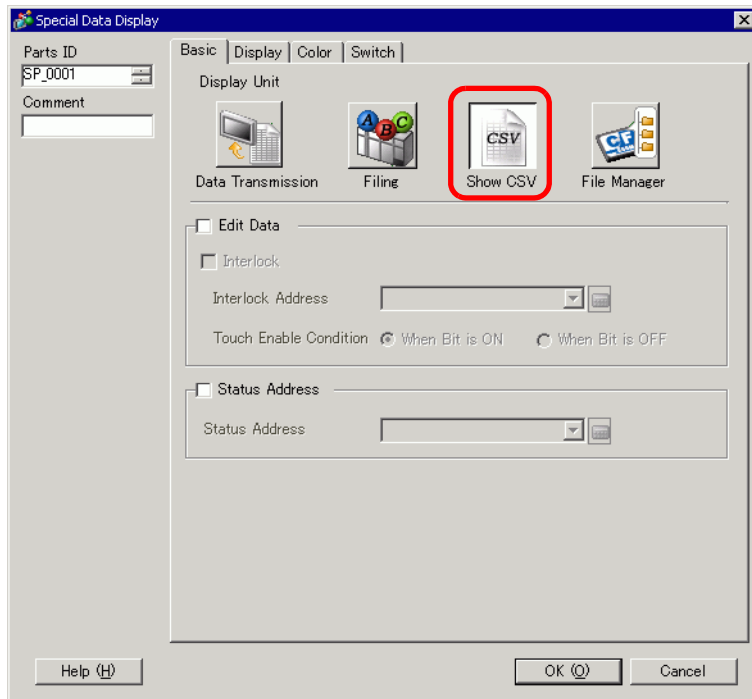

8 Select the [Edit Data] check box.

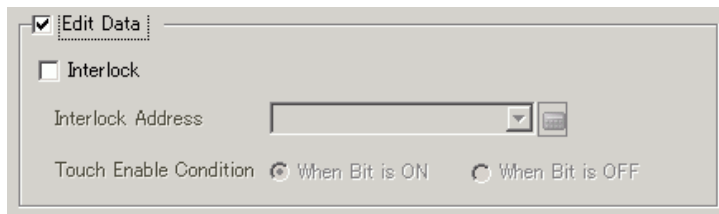

9 Click the [Display] tab. In [Font] set the [Font Type] and [Size]. Select the [Show Column] check box, if necessary.

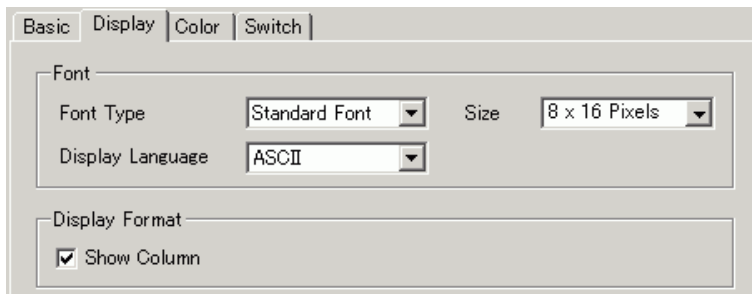

10 Click the [Color] tab. Set the text color and background color.

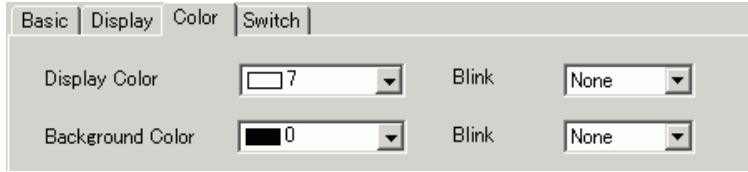

11 Click the [Switch] tab. Select the check boxes for any necessary scroll or print switches for the Show CSV. Set the number of rows or columns that a scroll switch moves when pressed. Select the shapes, label and text color. Click [OK].

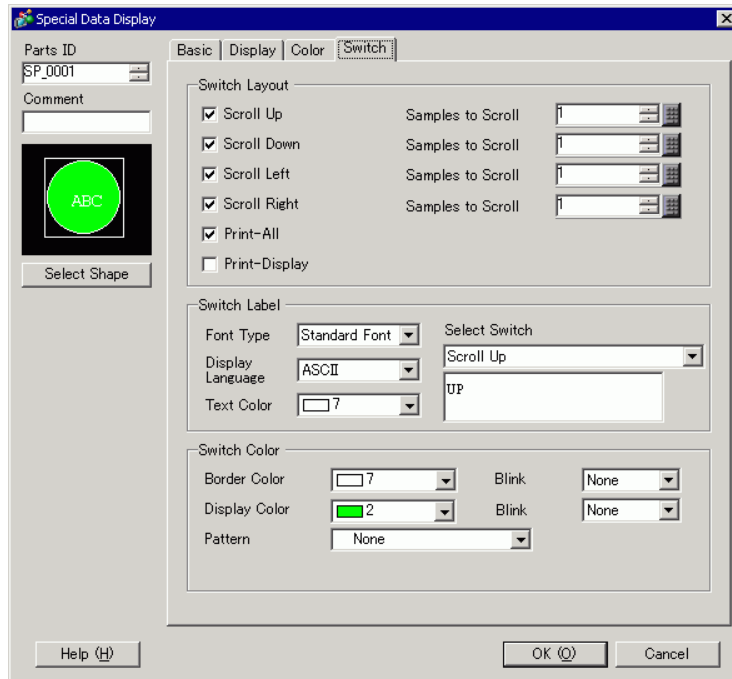

Special Data Display Part [Show CSV] is now configured. Move the switches to the desired locations.

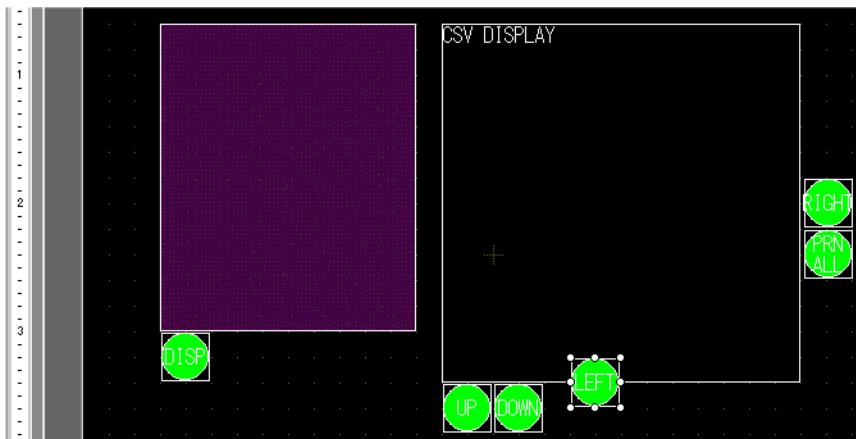

24.6.3 Operating Procedure

■ Displaying CSV Data

To display data in a Special Data Display [Show CSV], you need a Special Data Display [File Manager] to select files to display.

IMPORTANT

- A Special Data Display [File Manager] appears using a Special Window or Local Window. If the maximum number of windows already display, the File Manager does not appear. Close another window and touch the [File Manager] display switch again.
 ☞ "12.8 Restrictions for Windows" (page 12-29)

NOTE

- The CSV data on the USB storage device is operated from the CF ↔USB storage device [File Manager].

The following display method is intended for CSV data on a CF Card.

- 1 Touch the File Manager Display Switch to call up [File Manager] on the GP screen.

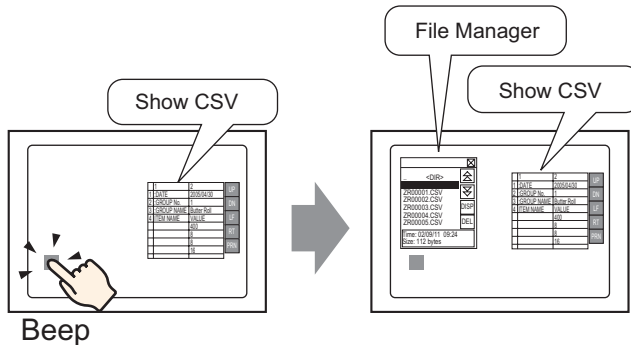

When the switch is pressed again, the [File Manager] window closes.

The contents of the CF Card's root folder display.

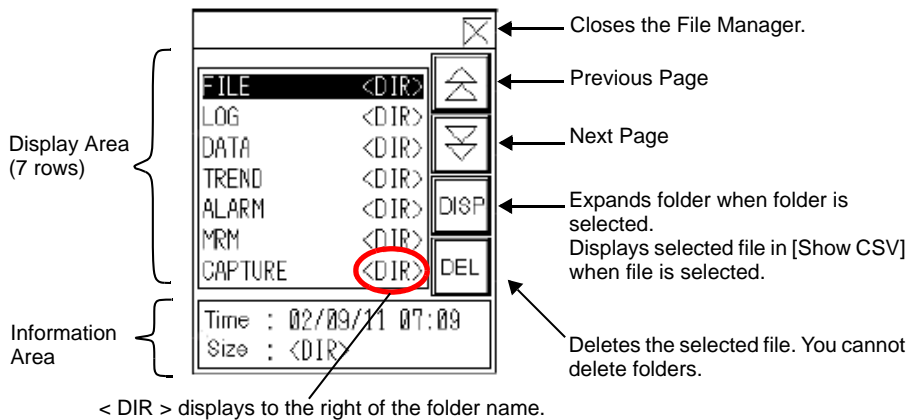

- **Display Area**
Displays the folder names and file names on the CF Card in a list.
The files display in the order in which they were created. It is not possible to sort the files by file numbers or time stamps.
- **Information Area**
When you select a folder, the folder creation date displays. Selecting a file displays the creation date and size of the file.

2 Select the folder and then touch the [DISP] key to display the folder contents.

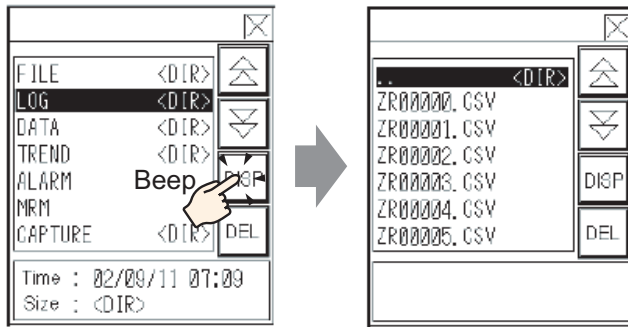

NOTE

- To navigate to a higher hierarchical folder, select the [. . DIR] row then touch the [DISP] key.

3 Select a file, and then touch the [DISP] key to view the file in the [Show CSV] dialog box.

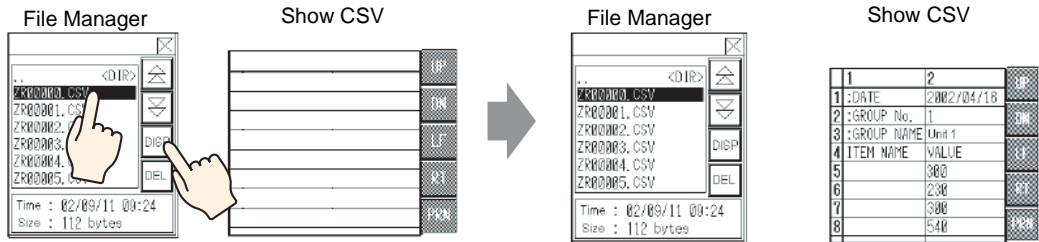

NOTE

- In the [File Manager], if you select files that are not CSV files and then touch the [DISP] key, those files do not appear in the [Show CSV] part.
- If the CF Card is removed or the cover of the CF Card slot is opened while the CSV file displays, the [Show CSV] dialog box is cleared.
- Switching screens clears the [Show CSV] display.

You can display all CSV data created with the GP in [Show CSV] dialog box.

Special Data Display Part [Show CSV]

1	2	UP	← Scroll Up
1 : DATE	2002/04/18	DN	← Scroll Down
2 : GROUP No.	1	LF	← Scroll Left
3 : GROUP NAME	Unit 1	RT	← Scroll Right
4 ITEM NAME	VALUE	PP	← Print CSV Data
5	300		
6	230		
7	300		
8	540		

NOTE

- You can enter a maximum of 100 characters in each cell.
- Each cell displays as text. The display is fixed as left-aligned.
- Character Code in the CSV File is Native only (press Shift JIS for Japanese).
- The outer borders are 2-dot lines, and the inner borders are 1-dot lines. Two-dot spaces are left between the borders that separate the cells and the data in the cells.

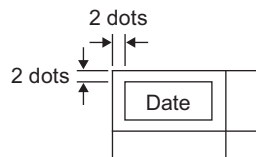

- The height of the cell is adjusted depending on the font size. The width of each cell adjusts depending on the text width. When the number of characters is five or less, the width is set to five characters.

How to Move File Manager

The screen position of Special Data Display [File Manager] can be changed.

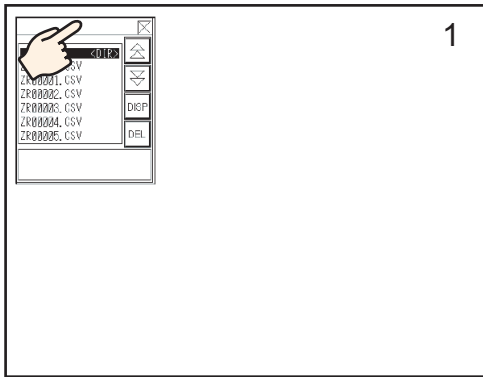

- 1 Touch the top of the [File Manager] Display.
- 2 Touch the desired position on the screen where you want the display to move.
- 3 The [File Manager] moves to the specified location.

NOTE

- If the [File Manager] Display runs off the screen at a specified position, the coordinates adjust so that the entire window displays.

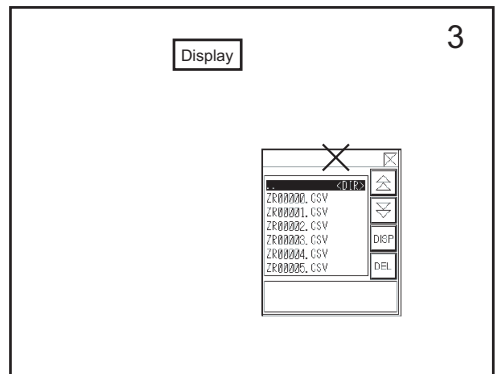
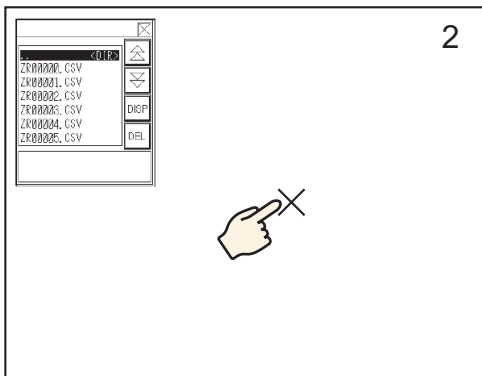

■ Editing CSV Data

When the Edit Data feature is set for the Special Data Display [Show CSV], by touching a displayed cell, the editing screen automatically displays. Touch the keypad on the editing screen to directly edit the CF Card or USB storage data.

Show CSV

Editing screen

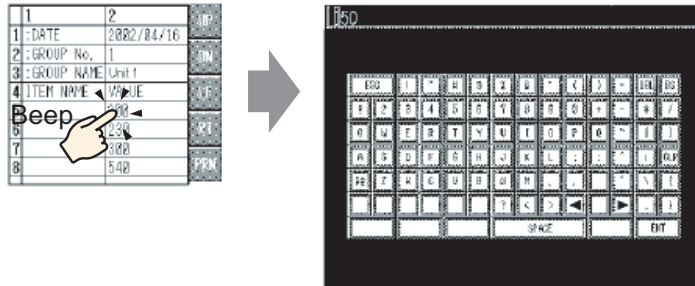

Touch the [ENT] key after editing data to save the changes and close the editing screen.

NOTE

- Touching the [CAPS] key allows you to enter lower-case characters. Touching the [CAPS] key again returns to upper-case input mode. The [CAPS] key is cleared when the editing screen closes.
- The input text on the editing screen displays with the font set to the CSV display. You cannot change the display color, position, and size.

■ Printing CSV Data

Touch the print switch on the Special Data Display [Show CSV] to print the displayed CSV data.

You can print only the portion in the [Show CSV].

NOTE

- To print data, you must connect a printer to the GP and then configure the printer settings.

☞ "33.3.2 Printer Setup Procedure" (page 33-14)

Print All

Touch [PRN ALL] for all CSV data on the [Show CSV], including the region not displayed on the screen, to print.

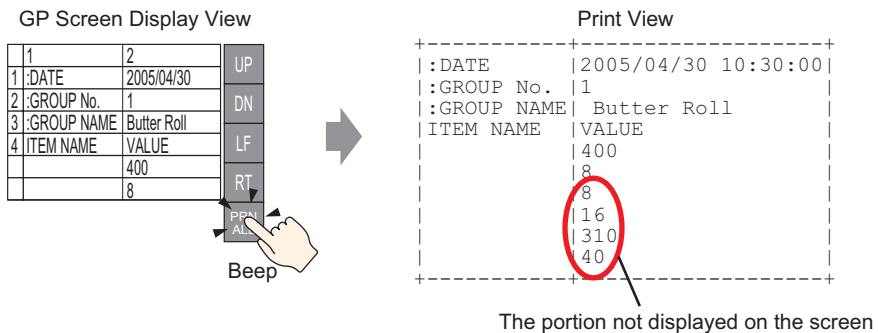

Print-Display

Touch [PRN] to print only the CSV data that displays on the screen.

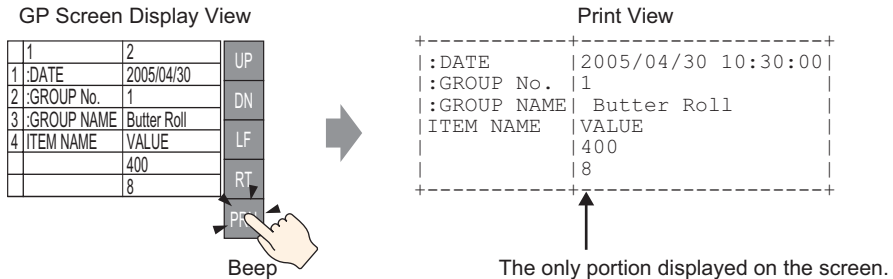

24.7 Creating Filing Data Recipes

24.7.1 Introduction

Create filing data recipes in GP-Pro EX.

Created data is sent to internal memory or saved to the CF Card inserted in the display unit via a screen transfer.

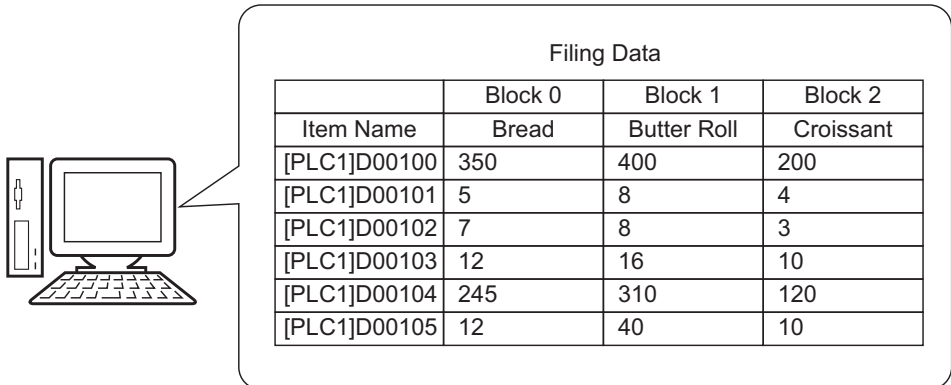

	Block 0	Block 1	Block 2
Item Name	Bread	Butter Roll	Croissant
[PLC1]D00100	350	400	200
[PLC1]D00101	5	8	4
[PLC1]D00102	7	8	3
[PLC1]D00103	12	16	10
[PLC1]D00104	245	310	120
[PLC1]D00105	12	40	10

NOTE

- You can save the recipe data on a CF Card as well as USB storage device. Transfer Project cannot transfer to a USB storage device placed on the display unit; you must copy the data to the USB storage device manually.

24.7.2 Setup Procedure

NOTE

- Please refer to the Settings Guide for details.
 ☞ "24.10.1 Common [Recipe] Setup Guide ■ Transferring Recipes (Filing Data List)" (page 24-68)

The following shows the operation procedure for registering new filing data when multiple folders are not used.

- 1 From the [Common Settings (R)] menu, point to [Recipe (R)] and select [Transfer Filing Data (Filing Data List) (D)]. The following window appears.

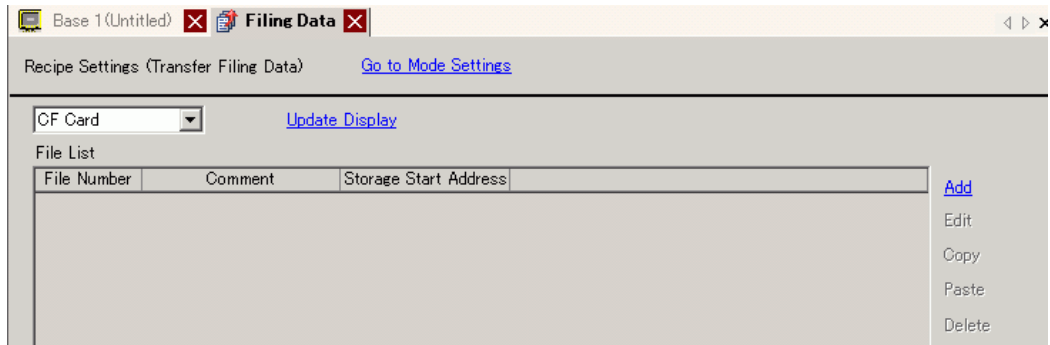

- 2 Set the save location for created filing data to [Internal Memory]. Filing data is stored in the GP internal memory via a screen transfer.

NOTE

- When you select [CF Card], the CF Card Folder must be set. When you select [USB storage], the USB Storage Destination Folder must be set. The recipe in the CF Card Folder can be transferred to the CF Card in the display unit using the Transfer Project tool. The data in the USB Storage Destination Folder must be copied to the USB storage device manually. You cannot use the Transfer Project tool to transfer to the USB storage device.

3 Click [Add]. The [Edit Filing Data] dialog box appears.

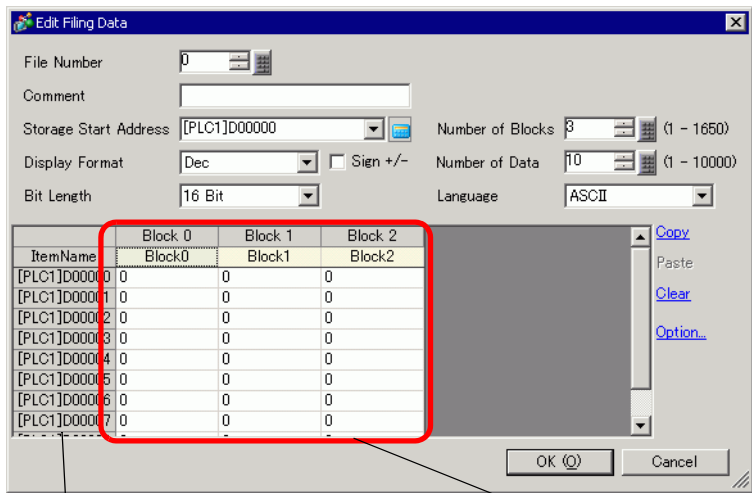

The number of consecutive addresses set in [Number of Data Items] display, starting from the address designated in [Storage Start Address].

Edit Data Area

4 In [Storage Start Address], set the start address of the destination (or source) device/PLC. The designated contents are set up in the [Edit Data Area]. Designate the filing data's [Display Format], [Bit Length] and [Sign +/-].

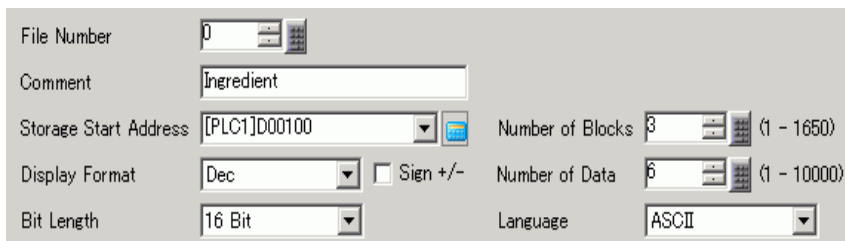

NOTE

- If you touch [Option], you can configure setting to transfer data with the item name and block number attached to it.
 - "24.12.2 Transferring Item Name and Block Number" (page 24-112)

5 In the [Edit Data Area], enter each recipe name and data.

	Block 0	Block 1	Block 2
ItemName	Bread	Butter Role	Croissant
[PLC1]D00000	350	400	200
[PLC1]D00001	5	8	4
[PLC1]D00002	7	8	3
[PLC1]D00003	12	16	10
[PLC1]D00004	245	310	120
[PLC1]D00005	12	40	10

6 Click [OK]. The new file is added to the [File List].

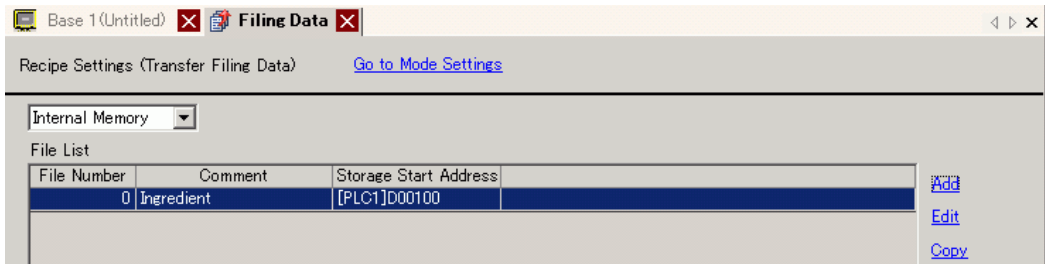

Filing data for File Number "0" is now configured.

24.8 Transferring Recipes (Filing Data) Using Manual Transfer

24.8.1 Introduction

On the GP, display a list of the filing data (recipes) stored in backup SRAM. Select which items you want to write to the device/PLC.

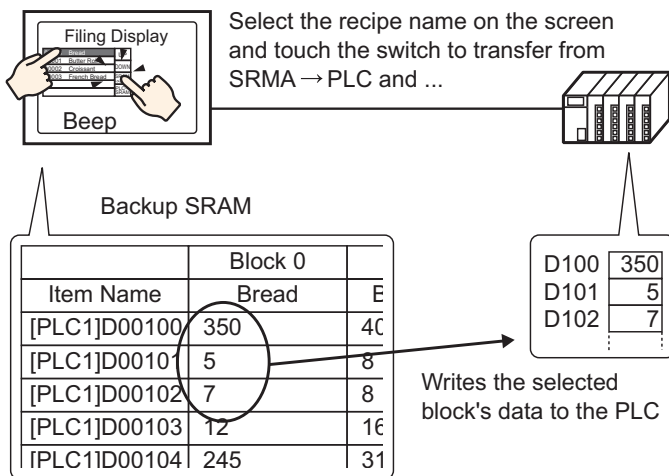

Also, device/PLC data overwrites the selected recipes in backup SRAM.

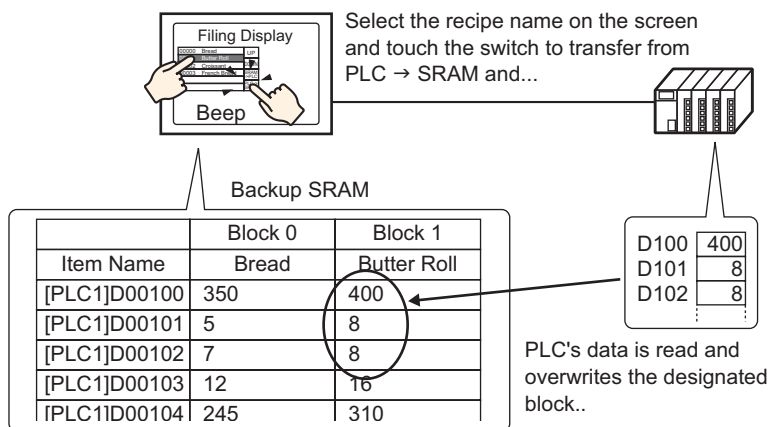

NOTE

- When transferring from device/PLC → backup SRAM, you cannot save as a new recipe. If you do not want to overwrite existing data, create an empty recipe in advance.
- You cannot edit backup SRAM's filing data on the GP screen. When transferring via the internal device, you can edit data stored in the internal device by using a Data Display part.

24.8.2 Setup Procedure

NOTE

- Please refer to the Settings Guide for details.
 - ☞ "24.10.1 Common [Recipe] Setup Guide ■ Transfer Recipe Data Settings" (page 24-64)
 - ☞ "24.10.2 [Special Data Display] Settings Guide ■ Filing Display" (page 24-80)
- For details of the part placement method and the address, shape, color, and label setting method, refer to the "Part Editing Procedure".
 - ☞ "8.6.1 Editing Parts" (page 8-52)

On the GP screen's Special Data Display [Filing], the following settings show how to designate and transfer the recipes by touching them.

- 1 From the [Common Settings (R)] menu, point to [Recipe (R)] and select [Transfer Filing Data (Mode) (A)] or click . The following window appears.

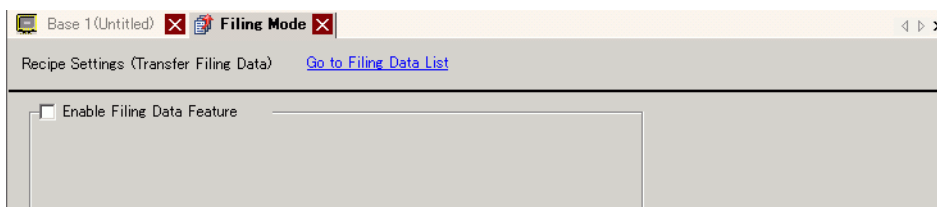

- 2 Select the [Enable Filing Data Feature] check box.

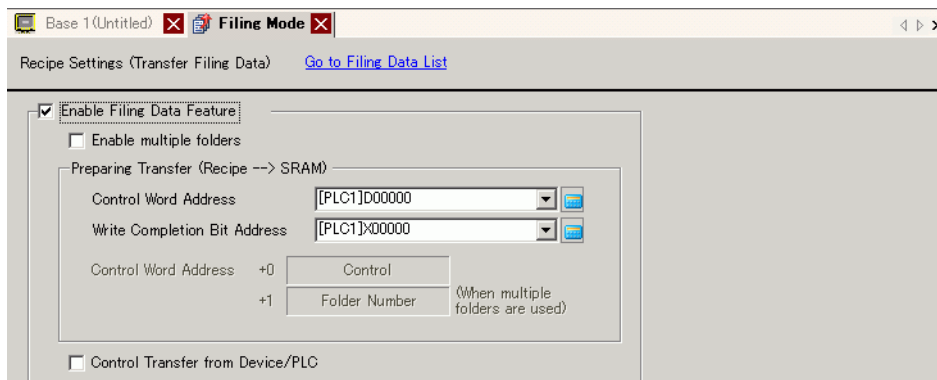

3 In [Control Word Address], set the address (D10) to write recipes stored in the display unit internal memory (or CF Card/USB Storage) to backup SRAM. Two consecutive words are used, starting from the set address.

In [Write Completion Bit Address], set the address (M100) to confirm that writing to backup SRAM is complete.



4 Open the screen editor. From the [Parts (P)] menu, point to [Special Data Display (P)] and select [Filing (F)]. Place the Part on the screen.

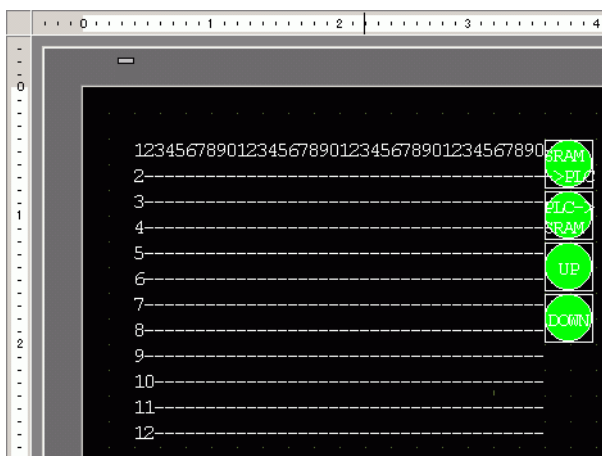

5 Double-click the new Special Data Display. The settings dialog box appears.

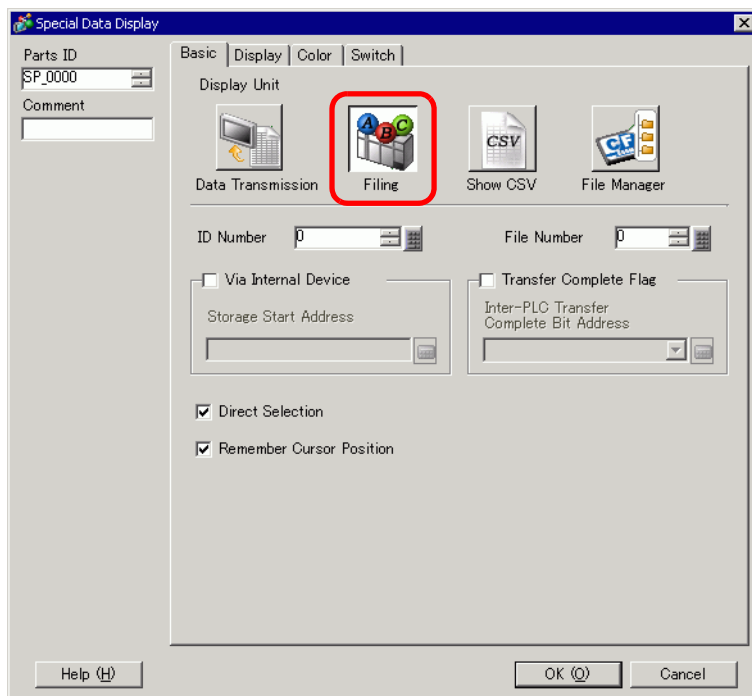

6 In [ID Number], set the number of the Special Data Display [Filing].

NOTE

- When displaying multiple Special Data Displays [Filing] on the screen, be sure not to use the same [ID Number].

7 In [File Number], set the file number of the Special Data Display [Filing] you want to display.

All the item names contained in the file designated here can be displayed in a list and transferred.

8 Select the [Display] tab. Set the [Font] and [Display Format].

The screenshot shows a dialog box with four tabs: Basic, Display (selected), Color, and Switch. Under the 'Display' tab, there are two main sections. The 'Font' section contains a 'Font Type' dropdown menu set to 'Standard Font' and a 'Size' dropdown menu set to '8 x 16 Pixels'. The 'Display Format' section contains three radio button options: 'No Border' (which is selected), 'Show Border', and 'Border with Horizontal Lines'. Below these options are two numeric input fields: 'Display Characters' with the value 40 and 'Display Rows' with the value 12.

9 Select the [Color] tab and set the text and background color.

The screenshot shows a dialog box with four tabs: Basic, Display, Color (selected), and Switch. Under the 'Color' tab, there are three rows of settings. Each row consists of a color selection dropdown (with a small color swatch), a 'Blink' dropdown menu, and a 'None' dropdown menu. The first row is 'Display Color' with a white swatch and the value '7'. The second row is 'Background Color' with a black swatch and the value '0'. The third row is 'Clear Color' with a black swatch and the value '0'.

- 10 Select the [Switch] tab and select the operation switches you want to place. Set the number of rows that a scroll switch moves when pressed. Select the shapes, label and text color. Click [OK].

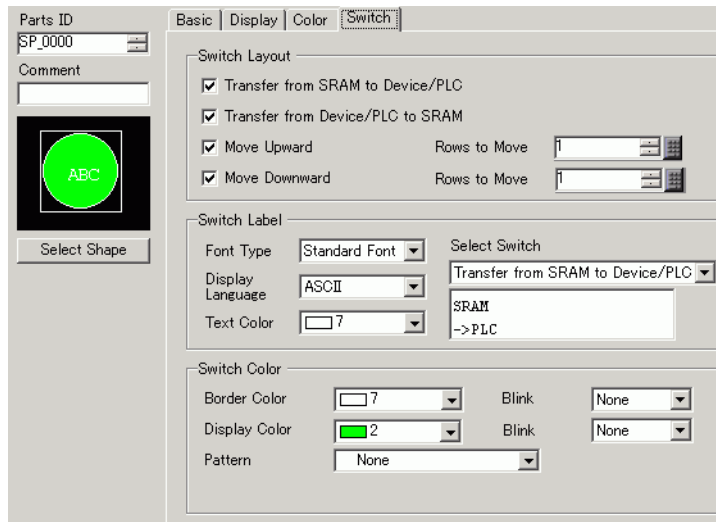

Special Data Display Part [Filing] is now configured. You can move the switches to the appropriate locations.

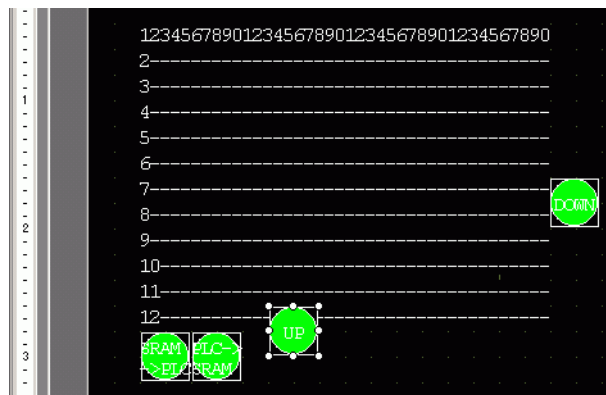

NOTE

- If you want to save recipes in SRAM to the CF Card or USB Storage, in the System Settings window, select [Display Unit] and click the [Mode] tab. In the [Memory Card Settings] area select the [Save Data] check box and define the [Control Word Address]. The Control Word Address works the same way as saving Alarm History to a CF card.

☞ "19.8.3 Structure ■ Control Word Address of Data Save" (page 19-60)

24.8.3 Transfer Process

The following shows the process for manual transfer from backup SRAM → device/PLC.
(When multiple folders are not used.)

- 1 Turn ON bit 0 in address D10. All the filing data recipes stored in internal memory are transferred to backup SRAM.

NOTE • When saving the recipes to the CF Card, turn ON bits 0 and 8. When saving the recipes to the USB storage device, turn ON bits 0 and 9.

- 2 When the transfer to backup SRAM has been completed successfully, turn ON the Write Completed Bit (M100). After confirming the bit is ON, turn OFF D10's bit 0 and M100.
- 3 In the Special Data Display [Filing] on the GP screen, the item names of registered blocks in the designated files inside backup SRAM display in a list.
Touch the recipe you want to transfer.
- 4 Touch the SRAM → PLC transfer switch.
The selected recipes transfer to the device/PLC.

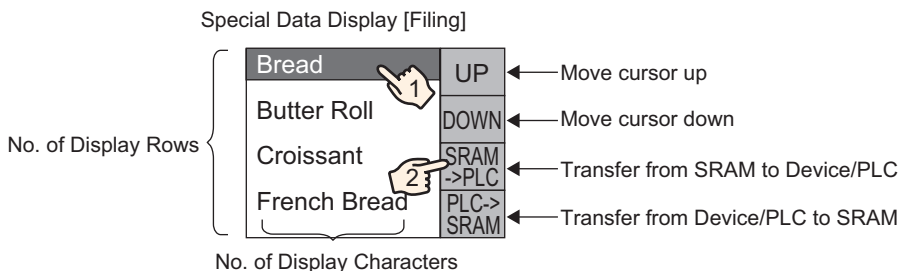

24.9 Transferring Recipes (Filing Data) Using Automatic Transfer

24.9.1 Introduction

Transfer recipes between the GP backup SRAM and device/PLC by turning ON the address used to control transfer.

- Transfer from Backup SRAM → Device/PLC
Designate the file no./block no. to transfer and turn ON the control address bit 0. The block data or recipe is written to the device/PLC.

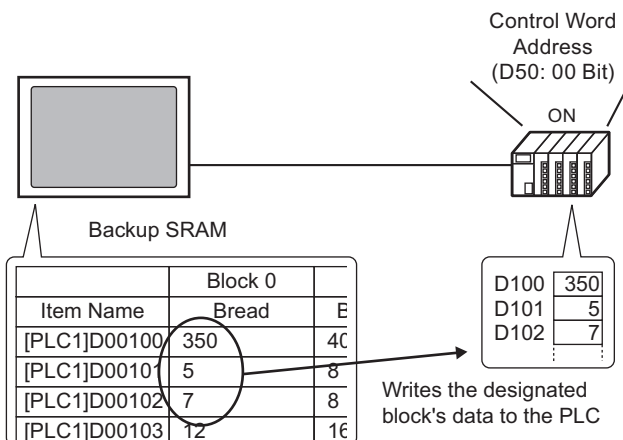

- Transfer from Device/PLC → Backup SRAM
Designate the recipe to transfer and turn ON the control address bit 0 and bit 8. Data from the device/PLC is saved to backup SRAM and overwrites the designated recipe.

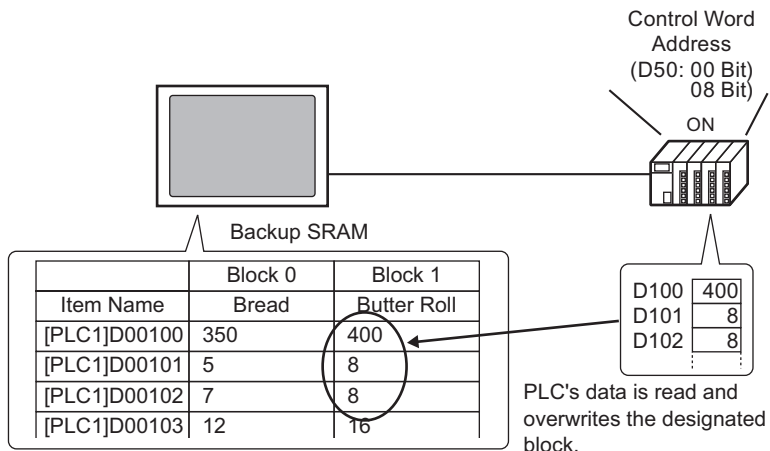

NOTE

- When you transfer from device/PLC → backup SRAM, you cannot save as a new recipe. If you do not want to overwrite existing data, create an empty recipe in advance.

24.9.2 Setup Procedure

NOTE

- Please refer to the Settings Guide for details.
 ☞ "24.10.1 Common [Recipe] Setup Guide ■ Transfer Recipe Data Settings" (page 24-64)

Configure settings to designate the file no./block no. and turn ON address D50 bit 0 and transfer the designated recipe.

- 1 From the [Common Settings (R)] menu, point to [Recipe (R)] and select [Transfer Filing Data (Mode) (A)] or click . The following window appears.

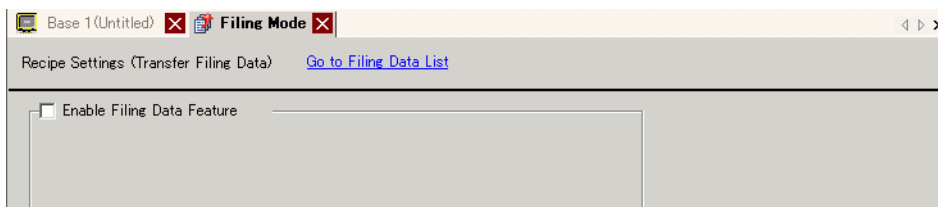

- 2 Select the [Enable Filing Data Feature] check box.

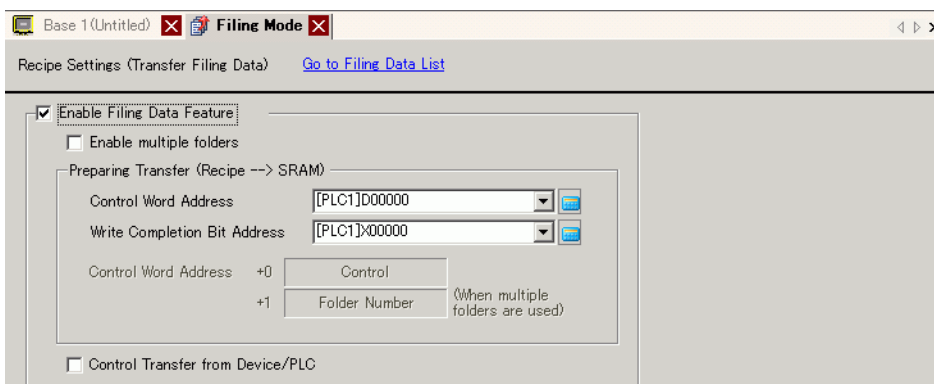

- 3 In [Control Word Address], set the address (D10) to write recipes stored in the display unit internal memory (or CF Card/USB Storage) to backup SRAM. Two consecutive words are used, starting from the set address.

In [Write Completion Bit Address], set the address (M100) to confirm that writing to backup SRAM is complete.

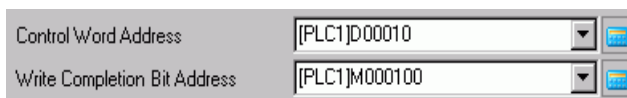

4 Select the [Control Transfer from Device/PLC] check box. The transfer settings appear.

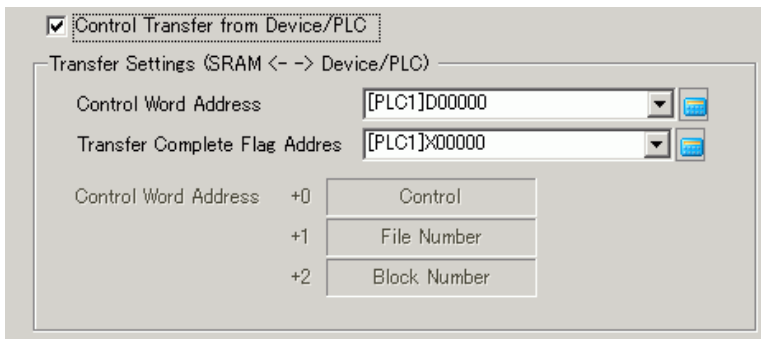

5 In [Control Word Address], set the address (D50) that controls the transfer between backup SRAM and the device/PLC. Three consecutive words are used, starting from the set address. In [Transfer Complete Flag Address], set the address (M101) used to verify that the transfer is complete.

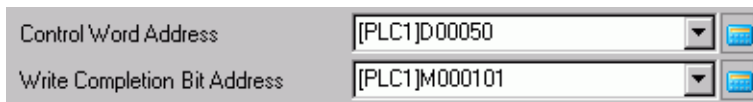

The automatic transfer settings are configured.

NOTE

- If you want to save recipes in SRAM to the CF Card or USB Storage, in the System Settings window, select [Display Unit] and click the [Mode] tab. In the [Memory Card Settings] area select the [Save Data] check box and define the [Control Word Address]. The Control Word Address works the same way as saving Alarm History to a CF card.

☞ "19.8.3 Structure ■ Control Word Address of Data Save" (page 19-60)

24.9.3 Transfer Process

Transfer from SRAM to Device/PLC Using One Folder

The following demonstrates how to transfer recipes to the device/PLC.

Transfer	
D50	Control
D51	File Number <- "0"
D52	Block Number <- "0"

- 1 Turn ON D10's bit 0. Filing data recipe stored in internal memory is transferred to backup SRAM.

NOTE

- When saving the recipes to the CF Card, turn ON bits 0 and 8. When saving the recipes to the USB storage device, turn ON bits 0 and 9.

- 2 When the transfer to backup SRAM has been completed successfully, turn ON the Write Completed Bit (M100). After confirming the bit is ON, turn OFF D10's bit 0 and M100.
- 3 In D51, store the File Number "0".
- 4 In D52, store the Block (Recipe) Number "0".
- 5 Turn ON D50's bit 0. The designated data in backup SRAM is transferred to the PLC.
- 6 When the transfer completes successfully, the Transfer Complete Flag (M101) turns ON. After confirming the bit is ON, turn OFF D50's bit 0 and M101.

Transfer Device/PLC→ SRAM

The following shows the process for reading the device/PLC data and storing it in File Number "0"/Block Number "1" in backup SRAM.

Transfer	
D50	Control
D51	File Number <- "0"
D52	Block Number <- "1"

- 1 In D51, store the File Number "0".
- 2 In D52, store the Block (Recipe) Number "1" where data that is read from the device/PLC is stored.
- 3 Turn ON D50's bit 0 and bit 8. Device/PLC's data overwrites block 1.
- 4 When the transfer completes successfully, the Transfer Complete Flag (M101) turns ON. After confirming the bit is ON, turn OFF D50's bit 0, bit 8, and M101.

24.10 Settings Guide

24.10.1 Common [Recipe] Setup Guide

■ Transfer CSV Data (Condition)

Configure condition and transfer settings for CSV data.

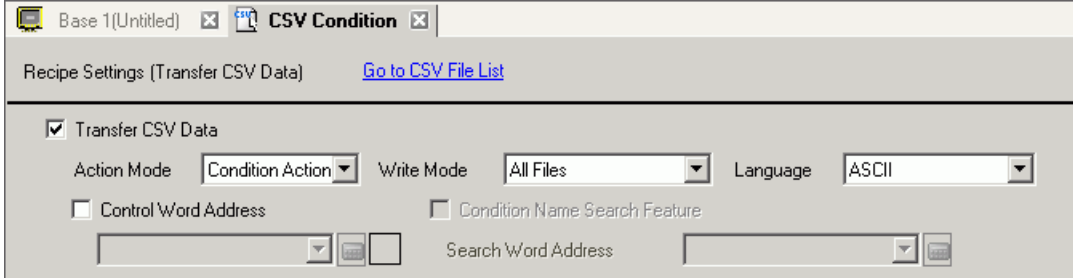

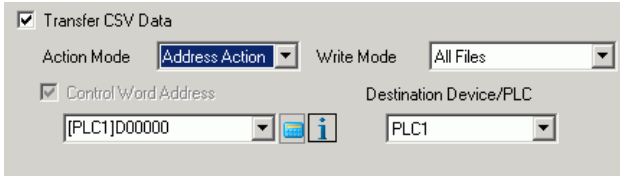
Setting	Description
Transfer CSV Data	Select whether to use the Transfer CSV Data feature.
Action Mode	<p>Select the CSV data's transfer action.</p> <p>NOTE</p> <ul style="list-style-type: none"> • When using a Special Data Display [Data Transmission] with manual transfer. Select [Condition Action]. • Condition Action The transfer is executed according to the condition set in [Condition], such as Destination Address or Number of Data Items. You can transfer multiple CSV data recipes at one time. • Address Action The transfer destination and source address is set at transfer time. Change the address for each file and transfer the CSV data. 

Continued

Setting	Description																																															
Write Mode	<p>Defines how to handle overwriting data.</p> <ul style="list-style-type: none"> • All Files Overwrites all the contents of existing CSV files. ITEM NAME field will be blank. • Overwrite Data Only Overwrites the Time (:DATE) and the Value (VALUE) in the existing CSV file. Other items remain unchanged. <p>IMPORTANT</p> <ul style="list-style-type: none"> • All data from the third row on in the CSV file are deleted. • When overwriting, the required available space on the CF Card or USB Storage is at least double the size of the actual CSV file. 																																															
Control Word Address	<p>Set to operate the CSV data transfer from the device/PLC with an automatic transfer. If selected, also set the address to control the transfer. The contents of the set address differ depending on the [Action Mode] settings.</p> <p>☞ "24.11.2 Control Word Address" (page 24-93)</p> <table border="1" data-bbox="428 768 1251 1209"> <thead> <tr> <th colspan="2" data-bbox="628 768 787 795">Condition Action</th> <th colspan="2" data-bbox="1081 768 1226 795">Address Action</th> </tr> </thead> <tbody> <tr> <td data-bbox="428 807 617 834">Control Word Address</td> <td data-bbox="622 807 817 834">Control</td> <td data-bbox="867 807 1056 834">Control Word Address</td> <td data-bbox="1064 807 1251 834">Control</td> </tr> <tr> <td data-bbox="592 842 617 869">+1</td> <td data-bbox="622 842 817 869">Status</td> <td data-bbox="1029 842 1056 869">+1</td> <td data-bbox="1064 842 1251 869">Status</td> </tr> <tr> <td data-bbox="592 877 617 904">+2</td> <td data-bbox="622 877 817 904">Number of Files (n)</td> <td data-bbox="1029 877 1056 904">+2</td> <td data-bbox="1064 877 1251 904">File Number</td> </tr> <tr> <td data-bbox="592 911 617 938">+3</td> <td data-bbox="622 911 817 938">File Number 1</td> <td data-bbox="1029 911 1056 938">+3</td> <td data-bbox="1064 911 1251 938">Mode</td> </tr> <tr> <td data-bbox="592 946 617 973">+4</td> <td data-bbox="622 946 817 973">File Number 2</td> <td data-bbox="1029 946 1056 973">+4</td> <td data-bbox="1064 946 1251 973">Address Mode</td> </tr> <tr> <td data-bbox="592 981 617 1008">+5</td> <td data-bbox="622 981 817 1008"></td> <td data-bbox="1029 981 1056 1008">+5</td> <td data-bbox="1064 981 1251 1008">Device Code</td> </tr> <tr> <td data-bbox="592 1016 617 1043">+6</td> <td data-bbox="622 1016 817 1043"></td> <td data-bbox="1029 1016 1056 1043">+6</td> <td data-bbox="1064 1016 1251 1043">Address Code</td> </tr> <tr> <td data-bbox="568 1051 617 1078">+2+n</td> <td data-bbox="622 1051 817 1078">File Number n</td> <td data-bbox="1029 1051 1056 1078">+7</td> <td data-bbox="1064 1051 1251 1078">(2 words)</td> </tr> <tr> <td></td> <td></td> <td data-bbox="1029 1085 1056 1112">+8</td> <td data-bbox="1064 1085 1251 1112">Number of Data Items</td> </tr> <tr> <td></td> <td></td> <td data-bbox="1029 1120 1056 1147">+9</td> <td data-bbox="1064 1120 1251 1209" rowspan="2">Reserved Area (7 words)</td> </tr> <tr> <td></td> <td></td> <td data-bbox="1029 1178 1056 1205">+15</td> </tr> </tbody> </table>	Condition Action		Address Action		Control Word Address	Control	Control Word Address	Control	+1	Status	+1	Status	+2	Number of Files (n)	+2	File Number	+3	File Number 1	+3	Mode	+4	File Number 2	+4	Address Mode	+5		+5	Device Code	+6		+6	Address Code	+2+n	File Number n	+7	(2 words)			+8	Number of Data Items			+9	Reserved Area (7 words)			+15
Condition Action		Address Action																																														
Control Word Address	Control	Control Word Address	Control																																													
+1	Status	+1	Status																																													
+2	Number of Files (n)	+2	File Number																																													
+3	File Number 1	+3	Mode																																													
+4	File Number 2	+4	Address Mode																																													
+5		+5	Device Code																																													
+6		+6	Address Code																																													
+2+n	File Number n	+7	(2 words)																																													
		+8	Number of Data Items																																													
		+9	Reserved Area (7 words)																																													
		+15																																														
Language	<p>Select a language for the Condition Name: [Japanese], languages supported by [ASCII], Simplified Chinese, Traditional Chinese, Korean, Cyrillic, and Thai. The Condition Name for the [Data Transmission] follows this setting.</p>																																															

Continued

Condition Name Search Feature	<p>When [Action Mode] is set to [Condition Action] and automatic transfer is used, disable the Condition Name Search feature. The Condition Name Search feature searches for CSV files by condition name and writes all matching files from the CF Card/USB to Device/PLC.</p> <p>☞ "24.11.3 About Condition Name Search Feature" (page 24-101)</p>
-------------------------------	---

Setting	Description								
<p>Search Word Address</p>	<p>When using Condition Name Search, set a word address to store the search text.</p> <p>This can be set to either a device/PLC address or GP internal device address.</p> <p>The lower 16 words of the address designated here (or 8 words for a 32 bit address) are used, and they store the condition name of the file you want to transfer. The condition search name can be up to 32 characters. A file whose condition name matches the stored string is detected in the CF Card/USB storage and is transferred.</p> <p> "24.11.3 About Condition Name Search Feature ◆ Condition Name Search Storing Methods" (page 24-105)</p> <p>NOTE</p> <ul style="list-style-type: none"> • The search is only possible when the search string is a perfect match for the condition name. Avoid using spaces as they can cause errors. • When data transfer is completed, the status and number of transferred files displays. The last transferred file numbers are written in the GP internal device Special Areas LS9200 and LS9201. (The Special Areas are read-only.) <div style="text-align: center; margin-top: 20px;"> <table border="1" style="margin-left: auto; margin-right: auto;"> <tr> <td colspan="2" style="padding: 5px;">LS Area</td> </tr> <tr> <td style="padding: 5px;">LS9200</td> <td style="width: 100px; height: 20px;"></td> </tr> <tr> <td style="padding: 5px;">LS9201</td> <td style="width: 100px; height: 20px;"></td> </tr> <tr> <td style="padding: 5px;"></td> <td style="width: 100px; height: 20px;"></td> </tr> </table> <div style="display: flex; justify-content: center; gap: 20px; margin-top: 5px;"> <div style="text-align: right; padding-right: 5px;">File Number of last transferred CSV file</div> <div style="text-align: left; padding-left: 5px;">File Number of last transferred CSV file</div> </div> </div>	LS Area		LS9200		LS9201			
LS Area									
LS9200									
LS9201									
<p>Destination Device/ PLC</p>	<p>When [Action Mode] is [Address Action], select the device/PLC for transfer.</p>								
<p>Condition</p>	<p>The contents of registered conditions display in a list.</p>								
<p>Create</p>	<p>Creates a new condition. Click to open the [CSV Data Transfer Condition] dialog box.</p>								
<p>Edit</p>	<p>Edit the condition selected in the [Condition list]. Click the hyperlink and the [CSV Data Transfer Condition] dialog box appears.</p>								
<p>Copy</p>	<p>Copy the condition selected in the [Condition list].</p>								
<p>Paste</p>	<p>Add the copied condition into the [Condition list].</p>								
<p>Delete</p>	<p>Delete the condition selected in the [Condition list].</p>								
<p>Duplication Check</p>	<p>Ensures that the file number settings for the condition are not duplicated. If file numbers are repeated, data is transferred according to the condition with the smaller number.</p>								

◆ [CSV Data Transfer Condition] Dialog Box

Condition Tab

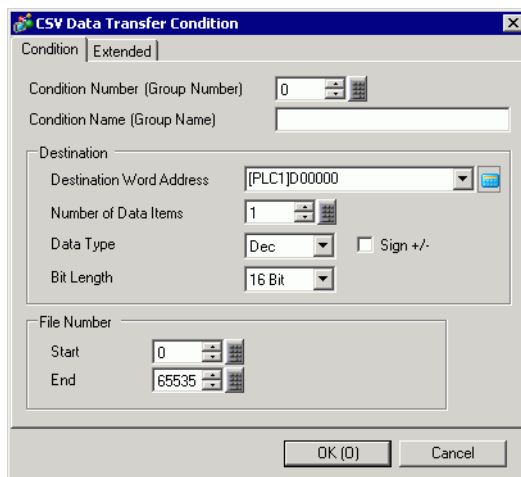

Setting		Description
Condition Number(Group Number)		Designate the condition number. The value can be from 0 to 1,023. Assign each conditions its own unique number.
Condition Name (Group Name)		Condition names can have a maximum of 32 characters. When transferring device/PLC to CF/USB, the CSV file condition name is defined here.
Destination	Destination Word Address	The specified address functions as the destination address (or as the source address when transferring from the device/PLC to the CF Card/USB storage device). An internal device address can also be set.
	Number of Data Items	Set the number of data transfer units from 1 to 10000.
	Data Type	Select the data type of the transfer data from [Dec], [Hex], or [Float]. NOTE • If [Float] is selected, [Bit Length] is fixed to [32 Bits].
	Sign +/-	When the [Display Format] is [Dec], specify whether negative numbers are used.
	Bit Length	Choose the bit length from [16 Bit] or [32 Bit].
File Number	Start/End	Set the file range to register as a single condition with file numbers. The value can be from 0 to 65,535. All the files from [Start] to [End] become part of the same group. NOTE • Please do not set the same file number to multiple conditions. If file numbers repeat in several conditions, the files are transferred according to the condition with the smallest number.

Extended

When automatically transferring from the device/PLC to the CF Card or USB storage device, you can automatically assign file numbers to create new files. This has no effect on automatic transfers from the CF Card or USB storage to the device/PLC.

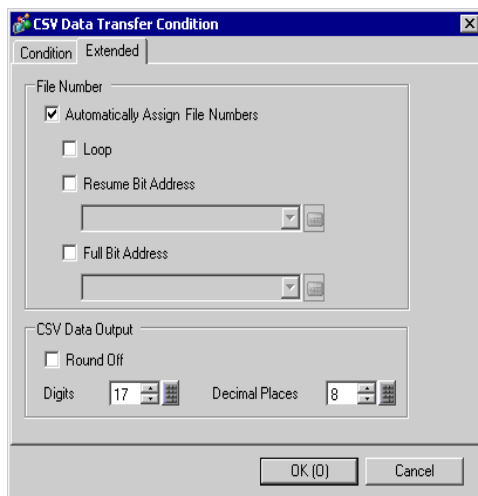

Setting	Description
Automatically Assign File Numbers	Enable this feature when reading data from the device and saving to a CF Card/USB storage as a CSV file. Numbering occurs until the designated [End]. After that, data is not transferred. To overwrite existing files and continue transferring, use [Loop] or [Resume Bit Address]. "24.11.4 About Automatic Numbering" (page 24-107)
Loop	Enable the loop action. If enabled, when the File Number reaches the designated [End], the oldest file is deleted and files are overwritten in order beginning with [Start] when a new file is created.
Resume Bit Address	Designate whether or not to set a bit address to resume transmission when the file number has reached the designated [End]. When this bit address is turned ON and after the [Control Word Address] is turned ON, files are created from the designated [Start].
Full Bit Address	Confirms that the file number has reached the designated [End]. This bit address turns ON when File Number reaches the [End].
CSV Data Output	Defines how to format data when output to a CSV file. This setting is available only when the [Data Type] in the Condition is set to [Float]. <ul style="list-style-type: none"> • Round Off Sets whether to round off digits. Numbers are truncated if not rounded. • Digits/Decimal Places In the [Digits] field, define the number of digits from 1 to 17, which includes the number of [Decimal Places]. The allowable range for [Decimal Places] should be less than the value set in [Digits].

■ Transferring CSV Data (CSV File List)

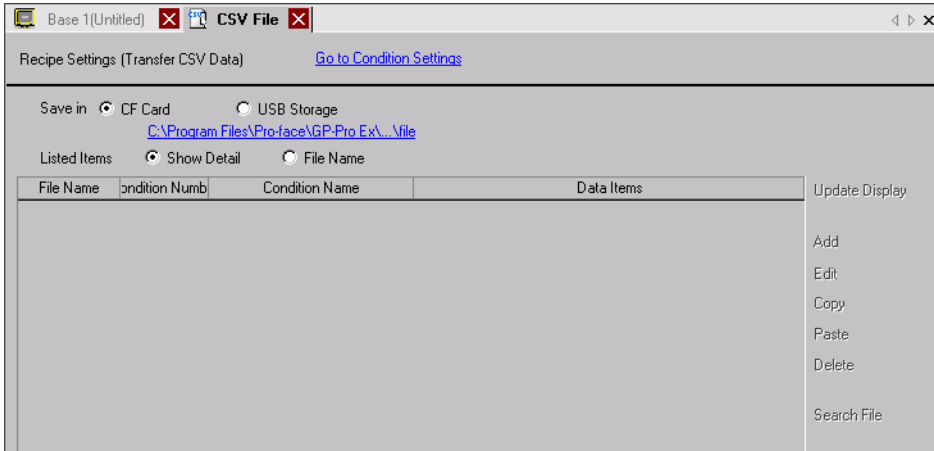

Setting	Description
Save in	Select the destination to save from [CF Card] or [USB Storage]. <ul style="list-style-type: none"> • CF Card The CF Card Folder needs to be specified. The data in this folder can be transferred to the CF Card in the GP by transfer project. • USB storage The USB Storage Destination Folder needs to be specified. The data in this folder cannot be transferred to the USB storage that placed by USB storage.
Listed Items	Select the displayed contents from the [CSV File List]. <ul style="list-style-type: none"> • Show Detail Condition Name and Number of Data Items settings display along with the file name. • File Name Only the file name displays.
CSV File List	The CSV File registered in GP-Pro EX displays as a list.
Update Display	Update the contents in [CSV File List].
Add	Register a new file. The file number can be any number from 0 to 65,535 that is not in use. <div style="text-align: center;"> </div>
Edit	Open the [Edit CSV File] dialog box to edit the content and condition of the file chosen in [CSV File List]. <p>☞ " ◆ [Edit CSV File] Dialog Box" (page 24-63)</p>
Copy	Copy the file selected in [CSV File List].
Paste	Add the copied file into [CSV File List]. The file number can be any number from 0 to 65,535 that is not in use.

Continued

Setting	Description
Delete	Delete the file selected in [CSV File List].
Search File	Creates and edits the index file.  "24.11.3 About Condition Name Search Feature ◆ What is Index File?" (page 24-102)

◆ [Edit CSV File] Dialog Box

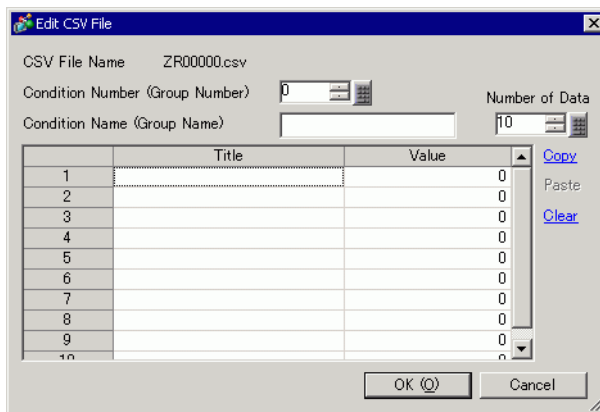

Setting	Description
Condition Number (Group Number)	Set the condition no. The value can be from 0 to 1,023.
Condition Name (Group Name)	Set the condition name with a maximum of 32 characters. When a Special Data Display [Data Transmission] is used, the condition name set here displays.
Number of Data Items	Set the number of recipe data from 1 to 10000.
Edit Data Area	Enter the recipe title and data. The title set here is not transferred to the device/PLC.
Copy	Copies the contents of the currently selected cell.
Paste	Pastes the copied contents into the selected cell.
Clear	Deletes the contents of the currently selected cell.

Transfer Recipe Data Settings

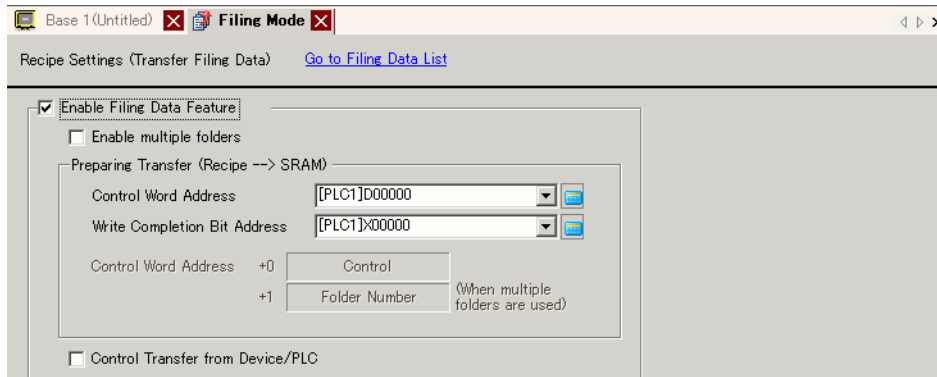

Setting		Description																			
Enable Filing Data Feature		Select to transfer filing data.																			
Enable multiple folders		Select to create multiple folders.																			
Preparing Transfer (Recipe → SRAM)	Control Word Address	<p>In the backup SRAM, specify the word address to write the recipe to. The address bit 0 turns ON and writes data to the backup SRAM. Use bit 8 and bit 9 to set the transfer operation.</p> <div style="text-align: center;"> <table border="1" style="margin: 10px auto;"> <tr> <td>Bit 9</td> <td>Bit 8</td> <td></td> </tr> <tr> <td>0</td> <td>0</td> <td>Internal Memory → SRAM</td> </tr> <tr> <td>0</td> <td>1</td> <td>CF Card → SRAM</td> </tr> <tr> <td>1</td> <td>0</td> <td>USB Storage → SRAM</td> </tr> <tr> <td>1</td> <td>1</td> <td>Reserved</td> </tr> </table> </div> <p>IMPORTANT</p> <ul style="list-style-type: none"> This address is not turned OFF automatically. After the [Write Completion Bit Address] turns ON, turn OFF bit 0. When using multiple folders, two words are used starting from the designated address. Store the folder number (1 - 8999) to write to backup SRAM, then turn ON bit 0 of the control address. Only one folder can be stored in backup SRAM. <div style="text-align: right; margin-top: 10px;"> <table border="1" style="border-collapse: collapse;"> <tr> <td style="padding-right: 5px;">Control Word Address</td> <td style="padding: 2px 5px;">Control</td> </tr> <tr> <td style="padding-right: 5px;">+1</td> <td style="padding: 2px 5px;">Folder Number</td> </tr> </table> </div>	Bit 9	Bit 8		0	0	Internal Memory → SRAM	0	1	CF Card → SRAM	1	0	USB Storage → SRAM	1	1	Reserved	Control Word Address	Control	+1	Folder Number
Bit 9	Bit 8																				
0	0	Internal Memory → SRAM																			
0	1	CF Card → SRAM																			
1	0	USB Storage → SRAM																			
1	1	Reserved																			
Control Word Address	Control																				
+1	Folder Number																				

Continued

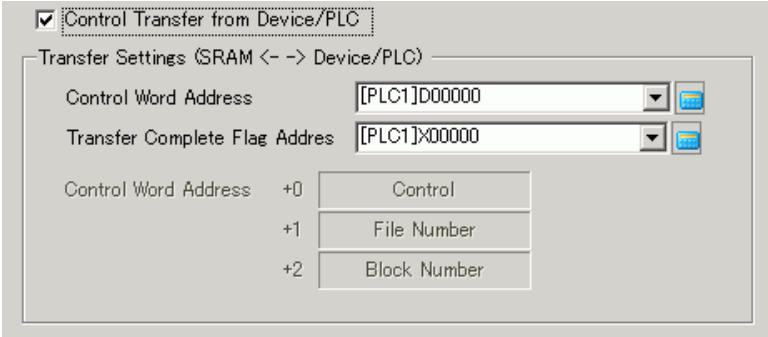
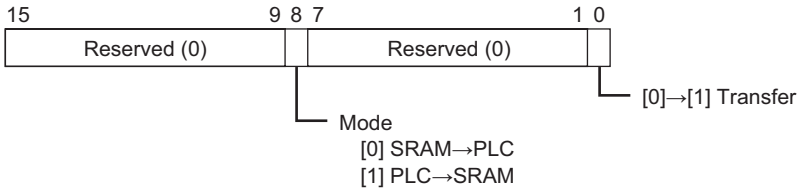
Setting		Description						
Preparing Transfer (Recipe → SRAM)	Write Completion Bit Address	<p>Set the Bit Address to verify when the data write to GP backup SRAM completes. When recipe data is stored correctly in backup SRAM, this bit turns ON. After confirming completion, turn OFF this bit.</p> <p>IMPORTANT</p> <ul style="list-style-type: none"> When the recipes cannot be transferred to the backup SRAM, bit 9 of the display unit's internal device LS2032 turns ON. 						
Control Transfer from Device/PLC		<p>Set to control the filing data transfer by the device/PLC (automatic transfer).</p>  <p>NOTE</p> <ul style="list-style-type: none"> For manual transfer, this setting is not required. 						
Transfer Settings (SRAM ↔ Device/PLC)	Control Word Address	<p>Set the word address that controls the transfer between backup SRAM and the device/PLC. Three consecutive words are used, starting from the designated address.</p> <table border="1" data-bbox="628 1108 1027 1205"> <tr> <td>Control Word Address</td> <td>Control</td> </tr> <tr> <td>+1</td> <td>File Number</td> </tr> <tr> <td>+2</td> <td>Block Number</td> </tr> </table> <p>After designating the File Number/Block Number, the transfer starts when this address' bit 0 turns ON. The transfer destination is set in bit 8.</p>  <p>IMPORTANT</p> <ul style="list-style-type: none"> This address is not turned OFF automatically. After confirming that the [Transfer Complete Flag Address] is ON, turn OFF bit 0. 	Control Word Address	Control	+1	File Number	+2	Block Number
Control Word Address	Control							
+1	File Number							
+2	Block Number							

Continued

Setting		Description
Transfer Settings (SRAM ↔ Device/ PLC)	Transfer Complete Flag Address	<p>Set the bit address that verifies that the data transfer between backup SRAM and the PLC is completed. When the transfer completes successfully, this bit turns ON. After confirming completion of the transfer, turn OFF this bit.</p> <p>IMPORTANT</p> <ul style="list-style-type: none"> If data transmission backup SRAM ↔ device/PLC cannot be run, the GP internal device LS2032 bit 10 turns ON.

Transfer Preparation Timing Chart

When the Control Word Address bit 0 turns ON and filing data is correctly stored in backup SRAM, the [Write Completion Bit Address] turns ON. After confirming completion, turn OFF this bit.

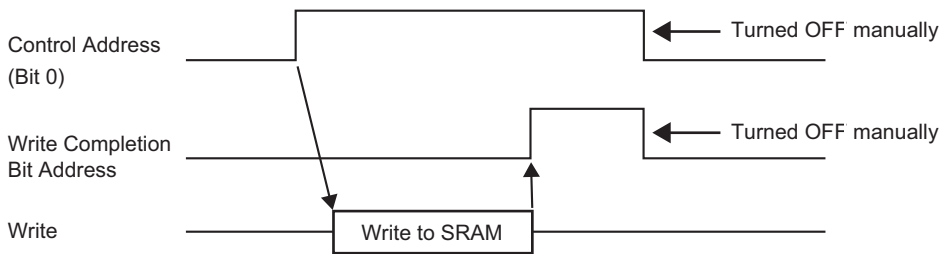

If data cannot be transmitted to backup SRAM due to insufficient memory, the internal device's (Special Relay Area's) LS2032 bit 9 is turned ON. To transfer data again, turn OFF the [Control Word Address]' bit 0 temporarily. Then, after setting the communication cycle time as either your standard communication cycle time or 150ms (whichever is longer), turn it ON.

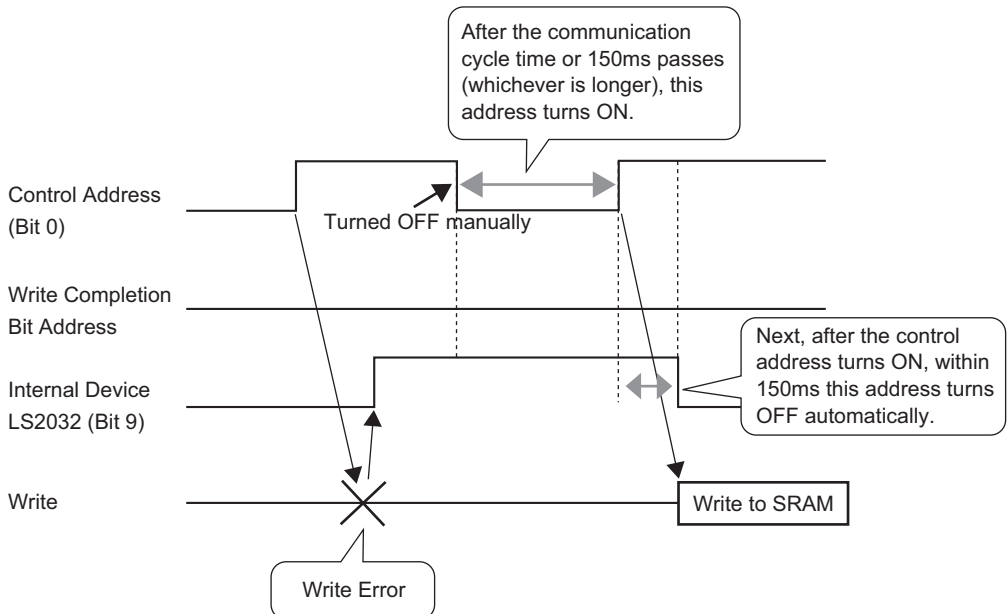

Automatic Transfer Timing Chart

When the designated [Control Word Address] bit 0 turns ON and filing data is correctly transferred, the [Transfer Complete Flag Address] turns ON. After confirming completion, turn OFF this bit.

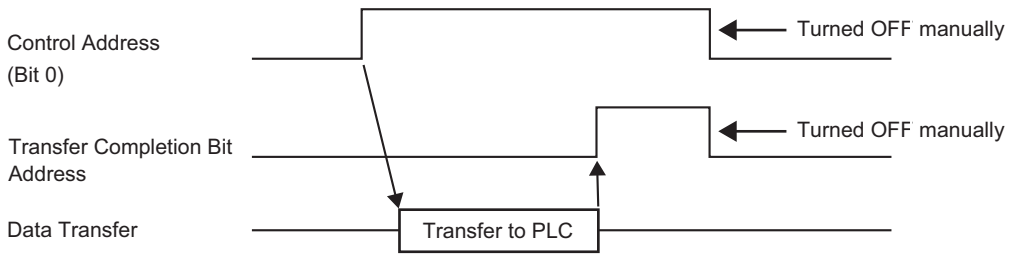

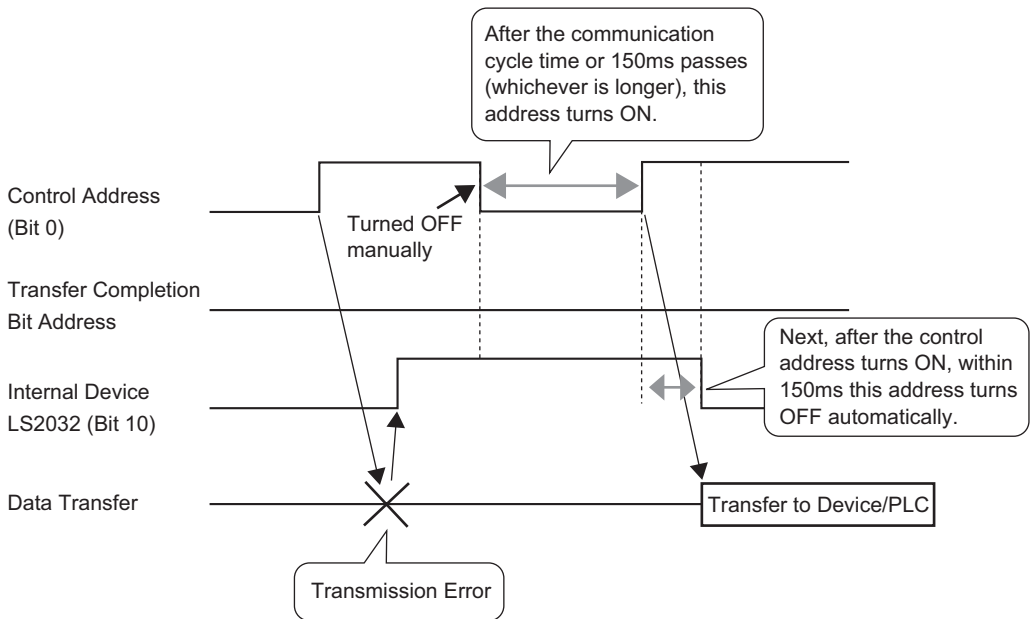

If data cannot be transmitted between the PLC and backup SRAM internal device Special Relay Area LS2032 bit 10 turns ON. To transfer data again, turn OFF the [Control Word Address]’s bit 0 temporarily. Then, after setting the communication cycle time as either your standard communication cycle time or 150ms (whichever is longer), turn it ON.

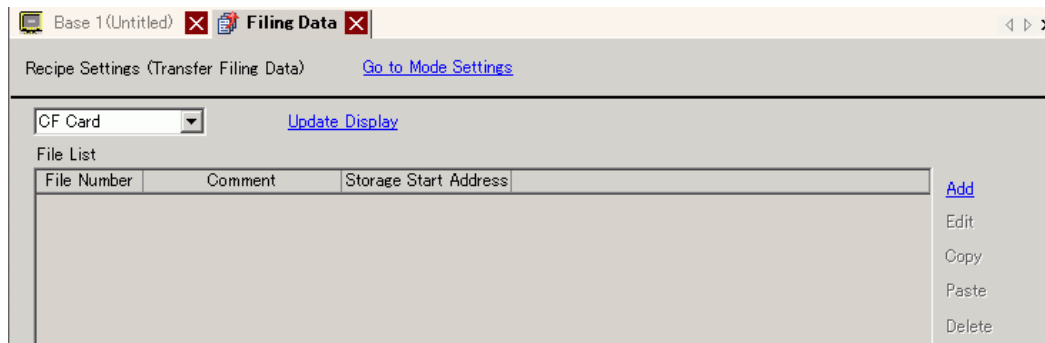

■ Transferring Recipes (Filing Data List)

When multiple folders are not used



Setting	Description
Save in	Select to save filing data in [Internal Memory], [CF Card], [USB storage]. <ul style="list-style-type: none"> • Internal Memory Save recipe data in the display unit's internal memory using the Transfer Project tool. • CF Card The CF Card Folder needs to be specified. The data in this folder is transferred to the CF card in the display unit using the Transfer Project tool. • USB storage The USB Storage Destination Folder must be specified. The data in this folder must be manually transferred to the USB storage device. It cannot be transferred using the Transfer Project tool.
File List	Displays a list of file number and storage start address of the registered recipes.
Update Display	Updates the summary that displays in [File List].
Add	Adds the recipes as a new entry. Click to open the [Edit Filing Data] dialog box.  " ◆ [Edit Filing Data] Dialog Box" (page 24-70)
Edit	Edit the file selected from [File List].
Copy	Copies the file selected in [File List].
Paste	Pastes the copied file into a new file in [File List]. The smallest available file number is allotted to the new file.
Delete	Deletes the selected file.

When multiple folders are used

If [Enable Multiple Folders] is selected, the [Folder List] displays. From the [Common Settings (R)] menu, point to [Recipe (R)] and select [Transfer Filing Data (Mode) (A)].

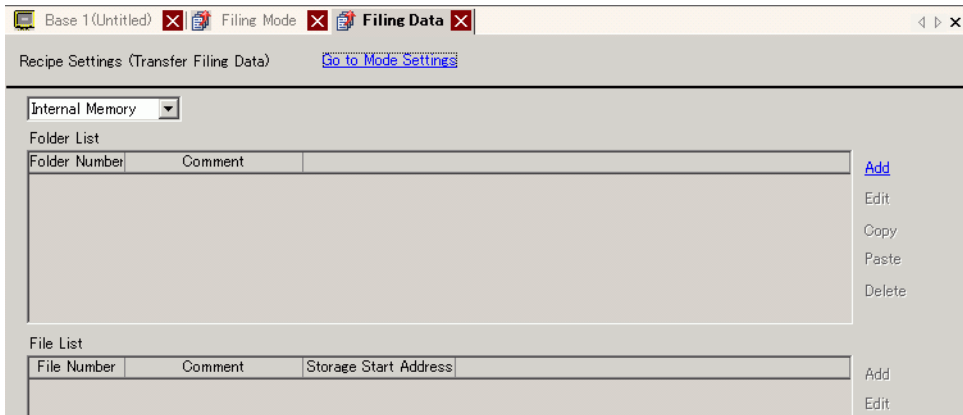

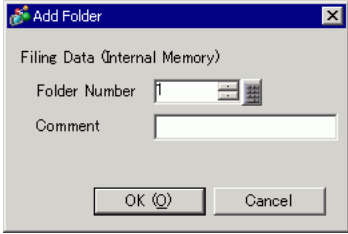
Setting	Description				
Folder List	Displays a list of registered folder numbers, which is the ***** portion of the file name "F*****.bin".				
Add	Creates a new folder to be saved. Click to open the [Add Folder] dialog box. <div style="text-align: center;">  </div>				
<table border="1" style="width: 100%; border-collapse: collapse;"> <tr> <td style="width: 150px;">Folder Number</td> <td>Set the folder number (the ***** portion in the file name *****.bin from 1 to 8,999).</td> </tr> <tr> <td>Comment</td> <td>Set a folder title of up to a maximum of 30 characters.</td> </tr> </table>	Folder Number	Set the folder number (the ***** portion in the file name *****.bin from 1 to 8,999).	Comment	Set a folder title of up to a maximum of 30 characters.	
Folder Number	Set the folder number (the ***** portion in the file name *****.bin from 1 to 8,999).				
Comment	Set a folder title of up to a maximum of 30 characters.				
Edit	Edit the folder number and comment for the selected folder.				
Copy	Copy the selected folder.				
Paste	Pastes the copied folder into a new folder in [Folder List].				
Delete	Deletes the selected folder.				

◆ [Edit Filing Data] Dialog Box

Setting	Description
File Number	Set the file number. The value can be from 0 to 2,047.
Comment	Set a comment of up to 32 characters.
Storage Start Address	In [Storage Start Address], set the start address of the destination (or source) device/PLC.
Display Format	Choose the data display type from [Dec], [BCD], [Hex], or [Float]. <div style="border: 1px solid black; padding: 2px; display: inline-block;">NOTE</div> <ul style="list-style-type: none"> • If [Float] is selected, [Bit Length] is fixed to [32 Bits].
Sign +/-	Set to allow negative numbers. This can only be set when the [Display Format] is [Dec].
Bit Length	Choose the data bit length from [16 Bit] or [32 Bit].
Blocks	Set the number of blocks (recipes) to register in the file. Up to 1,650 blocks can be saved in one file. The number of blocks that can be set depends on the [Number of Data Items].
Number of Data Items	Set the number of data per block. The number of data can be a maximum of 10,000 (or 5,000 when the data is 32 bit). The number of data that can be set depends on the [Number of Blocks].
Language	Select a language for the Item Name of filing data: [Japanese], languages supported by [ASCII], Simplified Chinese, Traditional Chinese, Korean, Cyrillic, and Thai. The Item Names in the [Filing] follow this setting.

Continued

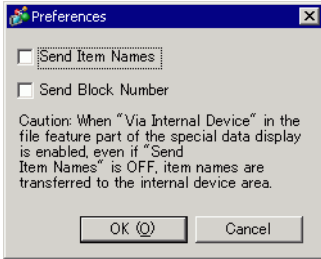
Setting	Description																															
Edit Data Area	<p>In each block, enter the recipe title and data. The range depends on the [Bit Length] and [Sign +/-].</p> <table border="1"> <thead> <tr> <th>Bit Length</th> <th>Data Type</th> <th>Sign +/-</th> <th>Input Range</th> </tr> </thead> <tbody> <tr> <td rowspan="4">16 Bit</td> <td rowspan="2">Dec</td> <td>Unchecked</td> <td>0 to 65535</td> </tr> <tr> <td>Checked</td> <td>-32,768 to 32,767</td> </tr> <tr> <td>Hex</td> <td>—</td> <td>0 to FFFF(h)</td> </tr> <tr> <td>BCD</td> <td>—</td> <td>0 to 9999</td> </tr> <tr> <td rowspan="5">32 bit</td> <td rowspan="2">Dec</td> <td>Unchecked</td> <td>0 to 4294967295</td> </tr> <tr> <td>Checked</td> <td>- 2147483648 to 2147483647</td> </tr> <tr> <td>Hex</td> <td>—</td> <td>0 to FFFFFFFF(h)</td> </tr> <tr> <td>BCD</td> <td>—</td> <td>0 to 99999999</td> </tr> <tr> <td>Float</td> <td>—</td> <td>-9.9e¹⁶ to 9.9e¹⁶</td> </tr> </tbody> </table>	Bit Length	Data Type	Sign +/-	Input Range	16 Bit	Dec	Unchecked	0 to 65535	Checked	-32,768 to 32,767	Hex	—	0 to FFFF(h)	BCD	—	0 to 9999	32 bit	Dec	Unchecked	0 to 4294967295	Checked	- 2147483648 to 2147483647	Hex	—	0 to FFFFFFFF(h)	BCD	—	0 to 99999999	Float	—	-9.9e ¹⁶ to 9.9e ¹⁶
Bit Length	Data Type	Sign +/-	Input Range																													
16 Bit	Dec	Unchecked	0 to 65535																													
		Checked	-32,768 to 32,767																													
	Hex	—	0 to FFFF(h)																													
	BCD	—	0 to 9999																													
32 bit	Dec	Unchecked	0 to 4294967295																													
		Checked	- 2147483648 to 2147483647																													
	Hex	—	0 to FFFFFFFF(h)																													
	BCD	—	0 to 99999999																													
	Float	—	-9.9e ¹⁶ to 9.9e ¹⁶																													
Copy	Copy the data from the selected cell.																															
Paste	Paste the copied data into the selected cell.																															
Clear	Delete the data in the selected cell.																															
Option	<p>Displays the [Preferences] dialog box. Configure settings for transfer.  "24.12.2 Transferring Item Name and Block Number" (page 24-112)</p>  <ul style="list-style-type: none"> • Send Item Names Select whether to transfer the item names when data transfers. • Send Block Number Select whether or not to transfer the block numbers when data transfers. 																															

24.10.2 [Special Data Display] Settings Guide

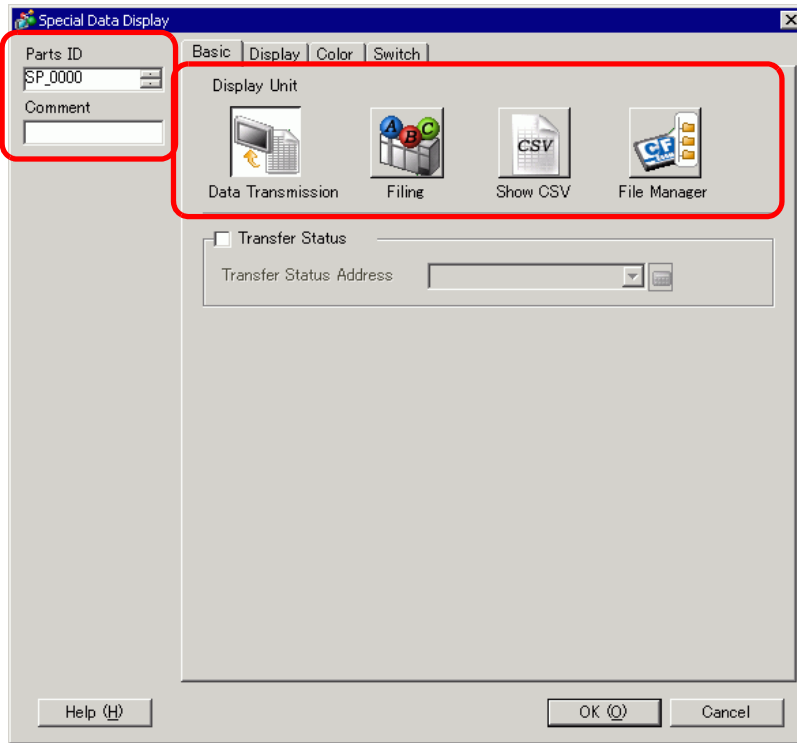

Setting	Description
Parts ID	Parts are automatically assigned an ID number. Special Data Display ID: SP_****(4 digits) The alphabetic portion is fixed. You can change the number part within the range of 0000-9999.
Comment	The comment for each Part can be up to a maximum of 20 characters.

Continued

Setting	Description
Display Unit	<p>Select which type to use.</p> <ul style="list-style-type: none">• Data Transmission Displays the CSV data recipe Condition Names in a list and transfers the selected recipe from the CF Card /USB storage to the device/PLC. ☞ " ■ Data Transmission" (page 24-74)• Filing Displays the recipe filing data in a list on the screen, and transfers the selected recipe from the display unit backup SRAM to the device/PLC. ☞ " ■ Filing Display" (page 24-80)• Show CSV *2 Displays the CSV data (e.g., recipe data, alarm history data, sampling data) saved on the CF Card/USB storage. You can also edit or print the data. The [File Manager] and [Data Transmission] display parts are used together. ☞ " ■ CSV Display" (page 24-83)• File Manager The File Manager displays folders and files saved in the CF Card /USB storage on the display unit. You can copy data between the CF Card and USB storage. You can also select and play movie files stored in the CF Card or the FTP Server. ☞ " ■ File Manager" (page 24-88)

■ Data Transmission

Displays a list of the recipe data (CSV data) condition names on the display unit. Transfers the selected data between the CF Card/USB storage and the device/PLC.

◆ Basic Settings

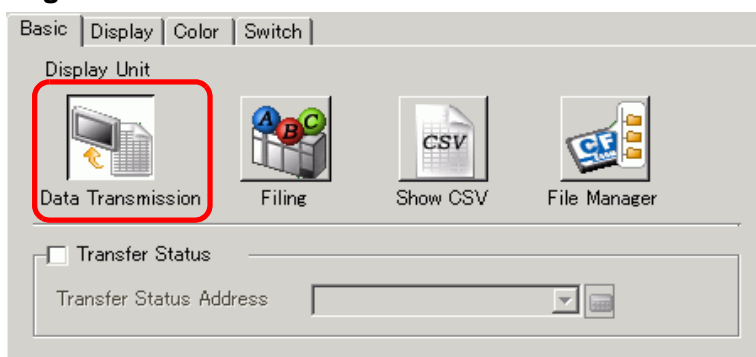

Setting	Description																											
Transfer Status	Select an address to verify the transfer state and result status during the transfer.																											
Transfer Status Address	<p>Set the address where the transfer status and result are stored.</p> <div style="text-align: center;"> <p>15 12 11 2 1 0</p> <p>Transfer Status Address Reserved (0) </p> <p style="text-align: right; margin-right: 50px;">└ Transferring</p> <p style="text-align: center; margin-left: 150px;">└ Error Status</p> <p style="text-align: right; margin-right: 50px;">└ Transfer Completed</p> </div> <p>Error Codes (Results reflected in the error status bits)</p> <table border="1" style="width: 100%; border-collapse: collapse;"> <thead> <tr> <th>Bit</th> <th>Condition</th> <th>Description</th> </tr> </thead> <tbody> <tr> <td>0</td> <td>Completed Successfully</td> <td>Transfer completed successfully.</td> </tr> <tr> <td>1</td> <td>Reserved</td> <td>-</td> </tr> <tr> <td>2</td> <td>No Transfer Condition Number</td> <td>For transfer, the Condition Number that corresponds to the specified File Number(GROUP NO) does not exist.</td> </tr> <tr> <td>3</td> <td>Internal Device Range Error</td> <td>In the CF Card/USB storage to device/PLC data transfer where the start address of the transfer is specified to the internal device, data transfer was attempted for an address outside the specified range of the internal device.</td> </tr> <tr> <td>4</td> <td>No CF Card or USB Storage</td> <td>The CF Card/USB storage is not inserted in the GP, or the CF Card cover is not closed.</td> </tr> <tr> <td>5</td> <td>Read Error</td> <td>The read-out from the CF Card/USB storage failed in the CF Card/USB storage to device/PLC data transfer.</td> </tr> <tr> <td>6</td> <td>Write Error</td> <td>Data writing failed in the device/PLC to CF Card/USB storage data transfer, or there is not enough available space.</td> </tr> <tr> <td>7</td> <td>CF Card Error/USB Storage Error</td> <td>The CF Card/USB storage is invalid or the media inserted is not a CF Card.</td> </tr> </tbody> </table> <p style="text-align: right;">Continued</p>	Bit	Condition	Description	0	Completed Successfully	Transfer completed successfully.	1	Reserved	-	2	No Transfer Condition Number	For transfer, the Condition Number that corresponds to the specified File Number(GROUP NO) does not exist.	3	Internal Device Range Error	In the CF Card/USB storage to device/PLC data transfer where the start address of the transfer is specified to the internal device, data transfer was attempted for an address outside the specified range of the internal device.	4	No CF Card or USB Storage	The CF Card/USB storage is not inserted in the GP, or the CF Card cover is not closed.	5	Read Error	The read-out from the CF Card/USB storage failed in the CF Card/USB storage to device/PLC data transfer.	6	Write Error	Data writing failed in the device/PLC to CF Card/USB storage data transfer, or there is not enough available space.	7	CF Card Error/USB Storage Error	The CF Card/USB storage is invalid or the media inserted is not a CF Card.
Bit	Condition	Description																										
0	Completed Successfully	Transfer completed successfully.																										
1	Reserved	-																										
2	No Transfer Condition Number	For transfer, the Condition Number that corresponds to the specified File Number(GROUP NO) does not exist.																										
3	Internal Device Range Error	In the CF Card/USB storage to device/PLC data transfer where the start address of the transfer is specified to the internal device, data transfer was attempted for an address outside the specified range of the internal device.																										
4	No CF Card or USB Storage	The CF Card/USB storage is not inserted in the GP, or the CF Card cover is not closed.																										
5	Read Error	The read-out from the CF Card/USB storage failed in the CF Card/USB storage to device/PLC data transfer.																										
6	Write Error	Data writing failed in the device/PLC to CF Card/USB storage data transfer, or there is not enough available space.																										
7	CF Card Error/USB Storage Error	The CF Card/USB storage is invalid or the media inserted is not a CF Card.																										

Setting	Description		
Transfer Status Address	8	Reserved	-
	9	Reserved	-
	10	Reserved	-
	11	No Condition	Without the [Enable Data Transmission Feature] settings, a CSV file tries to display on the CSV display from a CF Card/USB storage.
	12	Write Error	Data writing from CF Card/USB storage data transfer failed on the PLC.
	13	Read Error	Data reading from CF Card/USB storage data transfer failed on the PLC.

Manual Transfer Timing Chart

Touch the transfer switch and the [Transfer Status Address] Transferring bit (bit 0) turns ON. When a data transfer is completed successfully, the Transferring bit turns OFF and the Transfer Completion bit (bit 1) turns ON. After confirming that the transfer is finished, turn the Transfer Complete Flag Address OFF.

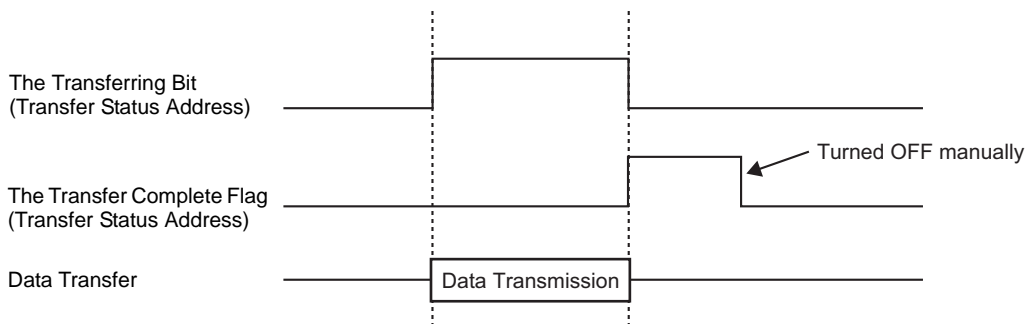

IMPORTANT

- The Transfer Complete Flag (bit 1) is not turned OFF automatically. Turn it OFF from the device/PLC.

◆ Display

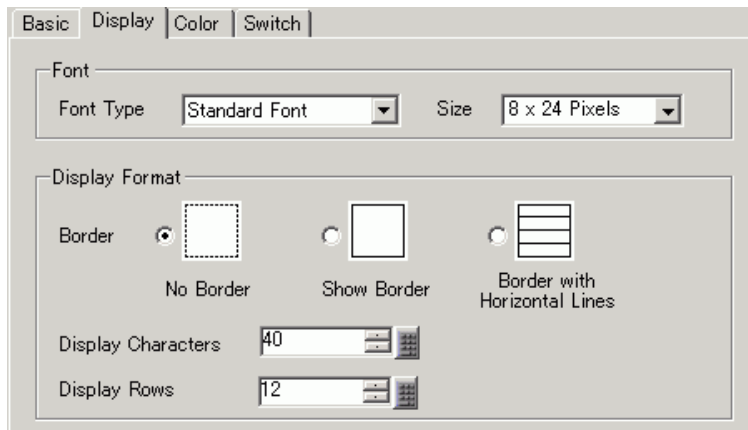

Setting	Description
Font Type	<p>Choose a font type for the characters and numeric values from [Standard Font] or [Stroke Font].</p> <ul style="list-style-type: none"> • Standard Font This is a Bitmap font. Choose the character height and width magnification ratio. When you magnify/shrink characters, the outline may become rough or the letter may appear compressed. • Stroke Font This is an outline font where the ratio of the character height/width is fixed. The letters will have a smooth outline even if you magnify/shrink them. However, this font uses more disk space on the GP.
Size	<p>Select a font size for the format of characters and numeric values.</p> <p>Standard Font: [8 x 8 dots] to [64 x 64 dots] in 8 dot increments. You can use fixed font sizes [6 x 10 dots], [8 x 13 dots], and [13 x 23 dots] for characters.</p> <p>Stroke Font: 6 to 127 dots</p>
Border	Select the type of data border.
Display Characters	Set the number of characters to display on each line from 1 to 100.
Display Lines	Set the number of lines to display from 1 to 50.

◆ Color

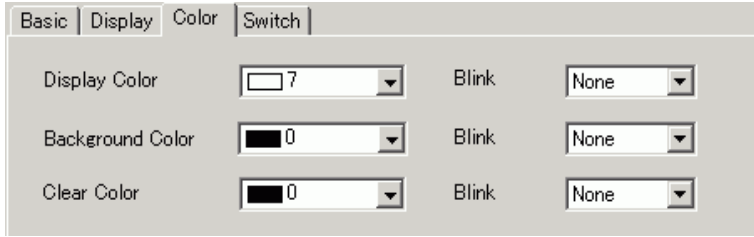

Setting	Description
Display Color	Select a color for the displayed text.
Background Color	Set the background color.
Blink	Select the Part blink and blink speed. You can choose different blink settings for the [Display Color], and [Background Color]. <div style="border: 1px solid black; padding: 2px; display: inline-block;">NOTE</div> <ul style="list-style-type: none"> • There are cases where you can and cannot set Blink depending on the Display Unit and System Settings' [Color Settings]. ☞ "8.5.1 Setting Colors ■ List of Available Colors" (page 8-42)

◆ Switch

Set the switches attached to the Data Transmission Display.

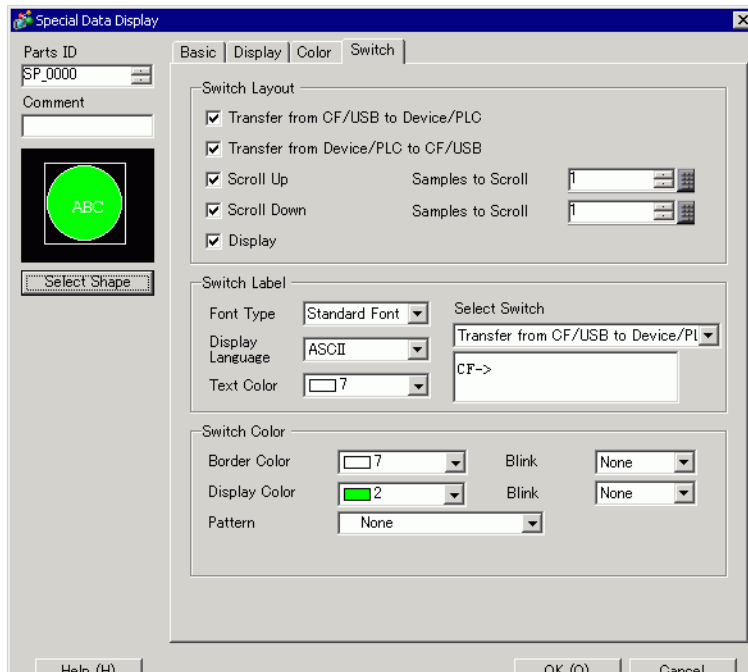

Setting	Description
Part Shape	Displays the switch shape.
Select Shape	Open the [Select Shape] dialog box to choose the switch shape.

Continued

Setting		Description
Switch Layout	Transfer from CF/USB to Device/PLC	Select to place a switch to transfer CSV data from CF Card/USB storage to the device/PLC.
	Transfer from Device/PLC to CF/USB	Select to place a switch to transfer CSV data from the device/PLC to the CF Card/USB storage.
	Scroll Up	Select to place a switch to scroll up the Data Display. If you touch this switch while CSV data is selected, the selection cancels.
	Scroll Down	Select to place a switch to scroll down the Data Display. If you touch this switch while CSV data is selected, the selection cancels.
	Samples to Scroll	When the [Scroll Up] and [Scroll Down] switches are placed, designate how many rows they scroll when pressed. The value can be between 1 and 100.
	Display.	Select to place a switch to display selected CSV file in the [Show CSV] Display. If you touch this switch when multiple CSV files are selected, the top CSV file displays in the [Show CSV].
Switch Label	Font Type	Choose the label font for the switches.
	Display Language	Select a language for the label on the switch: [ASCII], [Japanese], [Chinese (Traditional)], [Chinese (Simplified)], [Korean], [Cyrillic Alphabet] or [Thai].
	Text Color	Select the font color that will display on the switch labels.
	Select Switch	Select the switch that you want to type a label for.
	Label	Enter the text that you want to display on the switch selected in [Select Switch].

Continued

Setting		Description
Switch Color	Border Color	<p>Select a border color for the Switch.</p> <p>NOTE</p> <ul style="list-style-type: none"> Some settings cannot be set depending on the part that you chose with [Select Shape].
	Display Color	Set the switch color.
	Pattern	Select the switch pattern from 9 types.
	Pattern Color	Select the switch pattern color.
	Blink	<p>Select whether or not the Part will blink and the blink speed. You can choose different blink settings for the [Display Color], [Pattern Color], [Border Color], and [Text Color].</p> <p>NOTE</p> <ul style="list-style-type: none"> There are cases where you can and cannot set Blink depending on the Display Unit and System Settings' [Color Settings]. <p> "8.5.1 Setting Colors ■ List of Available Colors" (page 8-42)</p>

■ Filing Display

Display recipe filing data in a list on the screen and transfer the selected data between the GP backup SRAM and device/PLC.

◆ Basic Settings

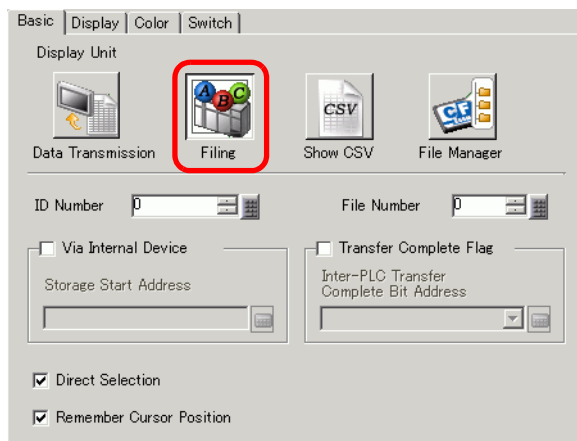

Setting	Description
ID Number	An ID number related to the [Filing] Display and a Switch Lamp [Special Switch] [File Item Switch]. The value can be between 0 and 255. When placing two or more [Filing] Displays on one screen, ensure that this number is unique.
File Number	Designate the filing data number to display in the [Filing] Display from 0 to 2,047.
Via Internal Device	Set to transfer via the internal device when transferring filing data. By temporarily storing filing data in the internal device, you can use a Data Display to view and edit data on the GP screen. "24.12.3 Manual Transfer Via the Internal Device" (page 24-114) NOTE <ul style="list-style-type: none"> While filing data is transferred between SRAM and the internal device, the GP internal device Special Relay Area LS2032 bit 11 is turned ON.
Storage Start Address	When [Via Internal Device] is set, select a start address for data stored there.
Transfer Complete Flag	Set to confirm that transfer SRAM ↔ device/PLC is complete with a designated bit.
Inter-PLC Transfer Complete Bit Address	Set the bit address to confirm that transfer is complete. NOTE <ul style="list-style-type: none"> If data transmission cannot be performed, this bit stays OFF, and the internal device Special Relay Area LS2032 bit 10 turns ON.
Direct Selection	To select data to transfer, touch displayed item names. Or, use the up/down cursor switches to select item names.
Remember Cursor Position	Set to save the current cursor position when a screen change occurs.

◆ **Display**

Same as for a Special Data Display [Data Transmission].

☞ "24.10.2 [Special Data Display] Settings Guide ◆ Display" (page 24-76)

◆ **Color**

Same as for a Special Data Display [Data Transmission].

☞ "24.10.2 [Special Data Display] Settings Guide ◆ Color" (page 24-77)

◆ **Switch**

Set the switches attached to the Filing Display.

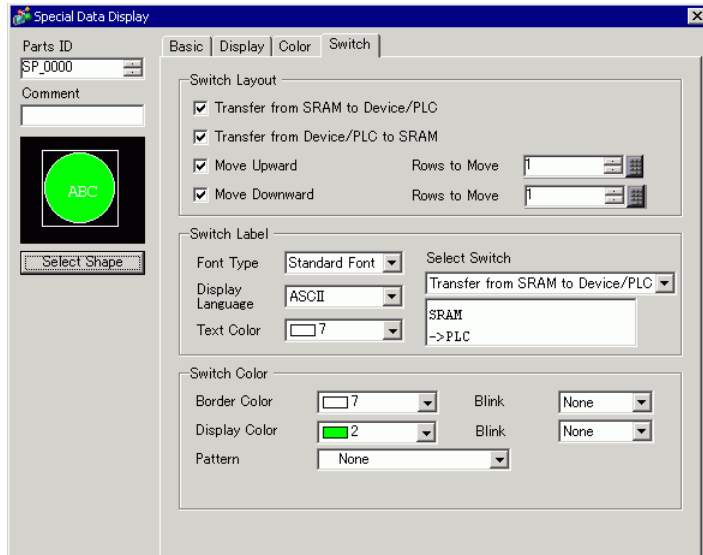

Setting		Description
Part Shape		Displays the shape that you chose for the switch with [Select Shape].
Select Shape		Open the [Select Shape] dialog box to choose the switch shape.
Switch Layout	Transfer from SRAM to Device/PLC	Select to place a switch to transfer filing data from backup SRAM to the device/PLC.
	Transfer from Device/PLC to SRAM	Select to place a switch to transfer filing data from the device/PLC to backup SRAM.
	Move Upward	Select to place a switch to move the cursor up.
	Move Downward	Select to place a switch to move the cursor down.
	Rows to Move	When you place a [Move Upward] or [Move Downward] switch, enter how many rows to move when pressed. The value can be between 1 and 2,048.

Continued

Setting		Description
Switch Label	Font Type	Choose the label font for the switches.
	Display Language	Select a language for the label on the switch.
	Text Color	Select the font color that will display on the switch labels.
	Select Switch	Select the switch that you want to type a label for.
	Label	Enter the text that you want to display on the switch selected in [Select Switch].
Switch Color	Border Color	<p>Select a border color for the Switch.</p> <p>NOTE</p> <ul style="list-style-type: none"> Some settings cannot be set depending on the part that you chose with [Select Shape].
	Display Color	Set the switch color.
	Pattern	Select the switch pattern from 9 types.
	Pattern Color	Select the switch pattern color.
	Blink	<p>Select whether or not the Part will blink and the blink speed. You can choose different blink settings for the [Display Color], [Pattern Color], [Border Color], and [Text Color].</p> <p>NOTE</p> <ul style="list-style-type: none"> There are cases where you can and cannot set Blink depending on the Display Unit and System Settings' [Color Settings]. <p>☞ "8.5.1 Setting Colors ■ List of Available Colors" (page 8-42)</p>

■ CSV Display

Displays CSV data (such as recipe data, alarm history data, sampling data) saved on the CF Card or USB storage. You can also edit or print the data.

The [File Manager] and [Data Transmission] display parts are used together.

◆ Basic Settings

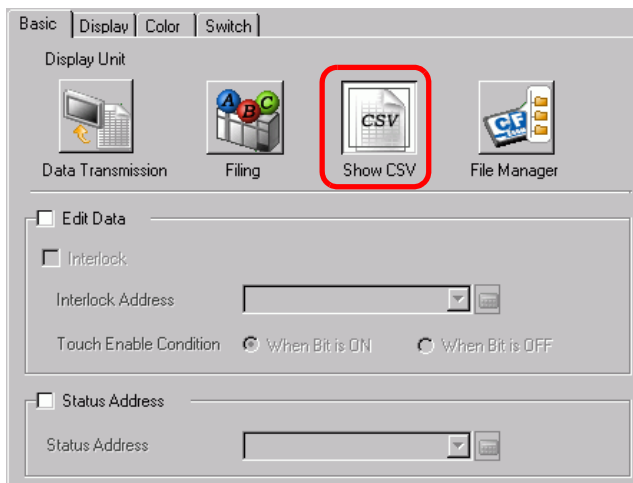

Setting	Description
Edit Data	Select to edit data in the CSV Display. If selected, touch the cell to edit; the editing screen appears.
Interlock	When [Edit Data] is designated, select whether to use the Interlock feature (allows data editing only when a condition is satisfied).
Interlock Address	If the Interlock feature is enabled, designate the address which will control whether touch is enabled or disabled. Only when this bit address is in the same state as the [Touch Enable Condition] can data be edited by touching it.
Touch Enable Condition	When using the Interlock feature, choose the condition which will enable touch. <ul style="list-style-type: none"> • ON Touch is only enabled when the designated [Interlock Address] is ON. • OFF Touch is only enabled when the designated [Interlock Address] is OFF.
Status Address	When editing or printing data, designate whether or not to confirm the status and error contents with the designated address.

Continued

Setting	Description																											
Status Address	<p>Set the word address to store the current status of data editing and printing.</p> <div style="text-align: center;"> </div> <p>Error Codes (Reflected in the error status bits)</p> <table border="1" style="width: 100%; border-collapse: collapse;"> <thead> <tr> <th style="width: 5%;">0</th> <th style="width: 30%;">Completed Successfully</th> <th style="width: 65%;">Transfer completed successfully.</th> </tr> </thead> <tbody> <tr> <td>1</td> <td>Reserved</td> <td>-</td> </tr> <tr> <td>2</td> <td>Reserved</td> <td>-</td> </tr> <tr> <td>3</td> <td>Reserved</td> <td>-</td> </tr> <tr> <td>4</td> <td>No CF Card or USB Storage</td> <td>The CF Card/USB storage is not inserted in the GP, or the CF Card cover is not closed.</td> </tr> <tr> <td>5</td> <td>Read Error</td> <td>Read-out from the CF Card/USB storage failed.</td> </tr> <tr> <td>6</td> <td>Write Error</td> <td>Data writing from CF Card/USB storage failed, or space is unavailable.</td> </tr> <tr> <td>7</td> <td>CF Card Error/USB Storage Error</td> <td>The CF Card/USB storage device is invalid or the media inserted is not a CF Card/USB storage device.</td> </tr> <tr> <td>8</td> <td>Reserved</td> <td>-</td> </tr> </tbody> </table> <ul style="list-style-type: none"> • Edit Data Outputting Bit This bit is turned ON when you press the "ENT" key on the CSV data editing screen. It remains ON while the CSV data is read to the CF Card/USB storage. While the edited data is output, the cell data cannot be printed or edited. • Printing Bit This bit is turned ON. You cannot edit data or execute other print jobs. 	0	Completed Successfully	Transfer completed successfully.	1	Reserved	-	2	Reserved	-	3	Reserved	-	4	No CF Card or USB Storage	The CF Card/USB storage is not inserted in the GP, or the CF Card cover is not closed.	5	Read Error	Read-out from the CF Card/USB storage failed.	6	Write Error	Data writing from CF Card/USB storage failed, or space is unavailable.	7	CF Card Error/USB Storage Error	The CF Card/USB storage device is invalid or the media inserted is not a CF Card/USB storage device.	8	Reserved	-
0	Completed Successfully	Transfer completed successfully.																										
1	Reserved	-																										
2	Reserved	-																										
3	Reserved	-																										
4	No CF Card or USB Storage	The CF Card/USB storage is not inserted in the GP, or the CF Card cover is not closed.																										
5	Read Error	Read-out from the CF Card/USB storage failed.																										
6	Write Error	Data writing from CF Card/USB storage failed, or space is unavailable.																										
7	CF Card Error/USB Storage Error	The CF Card/USB storage device is invalid or the media inserted is not a CF Card/USB storage device.																										
8	Reserved	-																										

◆ Display

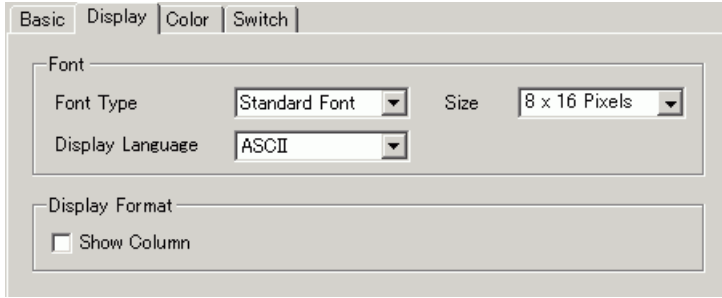

Setting	Description
Font Type	Choose a font type for the CSV data. <ul style="list-style-type: none"> • Standard Font This is a Bitmap font. Choose the character height and width magnification ratio. When you magnify/shrink characters, the outline may become rough or the letter may appear compressed. • Stroke Font This is an outline font where the ratio of the character height/width is fixed. The letters will have a smooth outline even if you magnify/shrink them. However, this font uses more disk space on the GP.
Size	Select a font size for the CSV data. Standard Font: [8 x 8 dots] to [64 x 64 dots] in 8 dot increments. You can use fixed font sizes [6 x 10 dots], [8 x 13 dots], and [13 x 23 dots] for characters. Stroke Font: 6 to 127 dots
Display Language	Select a language for the CSV data.
Show Column	Select to display the row number and column number in the [Show CSV]. The column portion cannot be edited or printed.

◆ Color

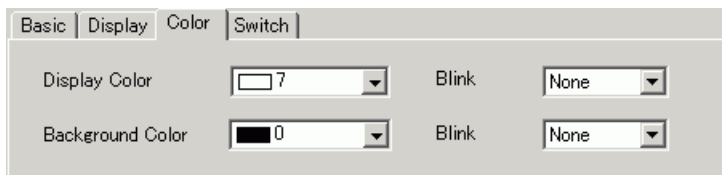

Setting	Description
Display Color	Select a color for the displayed text.
Background Color	Set the background color.

Continued

Setting	Description
Blink	<p>Select the Part blink and blink speed. You can choose different blink settings for the [Display Color], and [Background Color].</p> <p>NOTE</p> <ul style="list-style-type: none"> There are cases where you can and cannot set Blink depending on the Display Unit and System Settings' [Color Settings]. <small>☞ "8.5.1 Setting Colors ■ List of Available Colors" (page 8-42)</small>

◆ **Switch**

Configure settings for the switches (Scroll switches, Print switch) attached to the CSV Display.

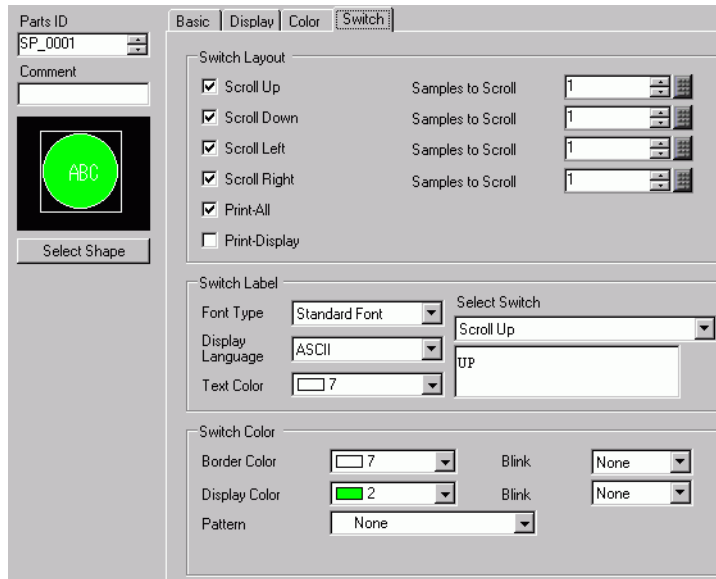

Setting	Description	
Part Shape	Displays the shape that you chose for the switch with [Select Shape].	
Select Shape	Open the [Select Shape] dialog box to choose the switch shape.	
Switch Layout	Scroll Up/ Scroll Down/ Scroll Left/ Scroll Right	Select to place switches to scroll the [Show CSV] Display in each direction.
	Samples to Scroll	When selecting a switch to place, set how many rows or columns to scroll when pressed. The value can be from 1 to 1,000.
	Print-All	Select to place a switch to print all CSV data.
	Print- Display	Select to place a switch to print the currently displayed CSV data.

Continued

Setting		Description
Switch Label	Font Type	Choose the label font for the switches.
	Display Language	Select a language for the label on the switch.
	Text Color	Select the font color that will display on the switch labels.
	Select Switch	Select the switch that you want to type a label for.
	Label	Enter the text that you want to display on the switch selected in [Select Switch].
Switch Color	Border Color	Select a border color for the Switch. <div style="border: 1px solid black; padding: 2px; display: inline-block;">NOTE</div> <ul style="list-style-type: none"> Some settings cannot be set depending on the part that you chose with [Select Shape].
	Display Color	Set the switch color.
	Pattern	Select the switch pattern from 9 types.
	Pattern Color	Select the switch pattern color.
	Blink	Select whether or not the Part will blink and the blink speed. You can choose different blink settings for the [Display Color], [Pattern Color], [Border Color], and [Text Color]. <div style="border: 1px solid black; padding: 2px; display: inline-block;">NOTE</div> <ul style="list-style-type: none"> There are cases where you can and cannot set Blink depending on the Display Unit and System Settings' [Color Settings].  "8.5.1 Setting Colors ■ List of Available Colors" (page 8-42)

■ File Manager

The File Manager displays data saved on the CF Card or USB storage device. You can also copy the data between CF Card and USB storage, and select and play movie files stored on the CF Card or FTP Server.

NOTE

- To display an image (JPEG file) in a CF Card, you should place and set the picture display as well as the file manager.
 ☞ " ■ CF Image Display" (page 9-43)
- The display unit cannot show JPEG files saved on the USB storage device.
- To play a Movie File stored in the CF Card or the FTP Server, you need to place and set the Movie Player as well as the File Manager.
 ☞ " ■ Selecting a Movie at Run Time" (page 26-33)

◆ Basic

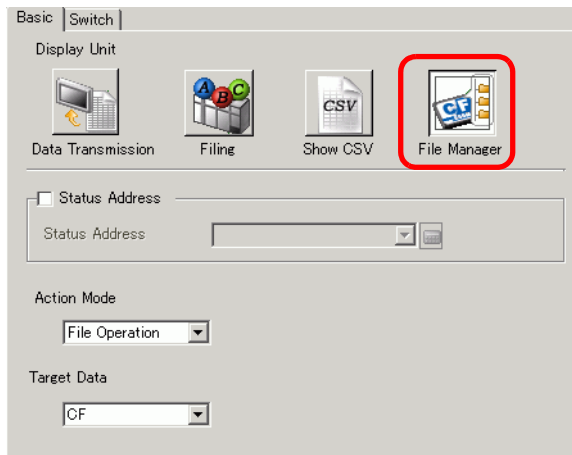

Setting	Description																																			
Status Address	Set to confirm error information with a set address.																																			
Status Address	<p>Set the word address to store the error status.</p> <div style="text-align: center;"> <table border="1" style="margin: auto;"> <tr> <td style="width: 20px;">15</td> <td style="width: 20px;"></td> <td style="width: 20px;">12</td> <td style="width: 20px;">11</td> <td style="width: 20px;"></td> <td style="width: 20px;"></td> <td style="width: 20px;"></td> <td style="width: 20px;"></td> <td style="width: 20px;"></td> <td style="width: 20px;">0</td> </tr> <tr> <td colspan="8" style="text-align: center;">Reserved (0)</td> <td style="width: 20px;"></td> <td style="width: 20px;"></td> </tr> </table> <p style="margin-left: 20px;"> Error Status 0->1 Transaction complete (Only [CF<-->USB storage] is selected) </p> <p style="margin-left: 20px;"> 0->1 Processing (Only [CF<-->USB storage] is selected) </p> </div> <p>Error Code (Reflected in the error status)</p> <table border="1" style="width: 100%; border-collapse: collapse;"> <tr> <td style="width: 50px; text-align: center;">0</td> <td style="width: 200px;">Completed Successfully</td> <td>Transfer completed successfully.</td> </tr> <tr> <td style="text-align: center;">1</td> <td>Reserved</td> <td>-</td> </tr> <tr> <td style="text-align: center;">2</td> <td>Reserved</td> <td>-</td> </tr> <tr> <td style="text-align: center;">3</td> <td>Reserved</td> <td>-</td> </tr> <tr> <td style="text-align: center;">4</td> <td>No CF Card</td> <td>No CF Card is inserted or the cover is open.</td> </tr> </table> <p style="text-align: right;">Continued</p>	15		12	11						0	Reserved (0)										0	Completed Successfully	Transfer completed successfully.	1	Reserved	-	2	Reserved	-	3	Reserved	-	4	No CF Card	No CF Card is inserted or the cover is open.
15		12	11						0																											
Reserved (0)																																				
0	Completed Successfully	Transfer completed successfully.																																		
1	Reserved	-																																		
2	Reserved	-																																		
3	Reserved	-																																		
4	No CF Card	No CF Card is inserted or the cover is open.																																		

Setting			Description																																	
Status Address			<table border="1"> <tr> <td>5</td> <td>Read Error</td> <td>Reading data from CF Card/USB storage failed.</td> </tr> <tr> <td>6</td> <td>Write Error</td> <td>Writing data to the CF Card/USB storage device, possibly due to insufficient disk space.</td> </tr> <tr> <td>7</td> <td>CF Card Error</td> <td>CF Card is invalid or the media inserted is not a CF Card.</td> </tr> <tr> <td>8</td> <td>Delete Error</td> <td>Read-only file, or file delete failed</td> </tr> <tr> <td>9</td> <td>FTP Connection Error</td> <td>FTP Server not working properly, or FTP Server does not exist</td> </tr> <tr> <td>10</td> <td>FTP Login Error</td> <td>User Name or Password set in the FTP Server not correct</td> </tr> <tr> <td>11</td> <td>FTP Read Error</td> <td>Reading file from an FTP server failed</td> </tr> <tr> <td>12</td> <td>Reserved</td> <td>-</td> </tr> <tr> <td>13</td> <td>Reserved</td> <td>-</td> </tr> <tr> <td>14</td> <td>USB storage None</td> <td>USB storage is not available.</td> </tr> <tr> <td>15</td> <td>USB storage Error</td> <td>USB storage cannot be accessed or the proper device is not inserted.</td> </tr> </table>	5	Read Error	Reading data from CF Card/USB storage failed.	6	Write Error	Writing data to the CF Card/USB storage device, possibly due to insufficient disk space.	7	CF Card Error	CF Card is invalid or the media inserted is not a CF Card.	8	Delete Error	Read-only file, or file delete failed	9	FTP Connection Error	FTP Server not working properly, or FTP Server does not exist	10	FTP Login Error	User Name or Password set in the FTP Server not correct	11	FTP Read Error	Reading file from an FTP server failed	12	Reserved	-	13	Reserved	-	14	USB storage None	USB storage is not available.	15	USB storage Error	USB storage cannot be accessed or the proper device is not inserted.
5	Read Error	Reading data from CF Card/USB storage failed.																																		
6	Write Error	Writing data to the CF Card/USB storage device, possibly due to insufficient disk space.																																		
7	CF Card Error	CF Card is invalid or the media inserted is not a CF Card.																																		
8	Delete Error	Read-only file, or file delete failed																																		
9	FTP Connection Error	FTP Server not working properly, or FTP Server does not exist																																		
10	FTP Login Error	User Name or Password set in the FTP Server not correct																																		
11	FTP Read Error	Reading file from an FTP server failed																																		
12	Reserved	-																																		
13	Reserved	-																																		
14	USB storage None	USB storage is not available.																																		
15	USB storage Error	USB storage cannot be accessed or the proper device is not inserted.																																		
Mode	File Operation	Target Data	<ul style="list-style-type: none"> • CF Displays folders or files saved in the Saving Data in the CF Card on the screen • CF↔USB storage You can display both CF card and USB storage at the same time, and copy and move the date between the CF card and USB storage. Use it when you display the CSV data in USB storage on the [CSV Display]. 																																	
	Select Movie	Selection Mode	<ul style="list-style-type: none"> • Single You can select and play only one movie file stored in the CF Card or the FTP server. • Multiple You can select and play movie files stored in the CF Card or the FTP server. You can select up to 100 files or folders. Index Numbers will be allocated in order from "0" just like Play List files. Playback will start from the Index Number 0. 																																	
		Target Data	<ul style="list-style-type: none"> • CF You can select data in the CF Card. • FTP You can select data in the FTP Server. • CF/FTP You can select data in the CF Card or the FTP Server. 																																	

◆ **Switch**

Configure the parameters for the Display switch used to call up the [File Manager] Display from a base screen.

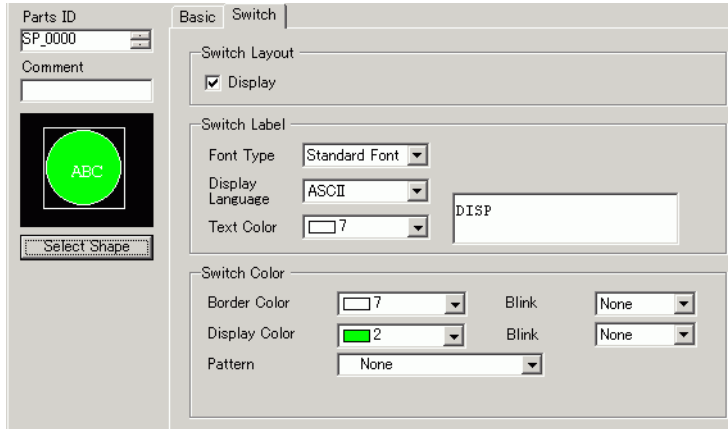

Setting		Description
Part Shape		Displays the shape that you chose for the switch with [Select Shape].
Select Shape		Open the [Select Shape] dialog box to choose the switch shape.
Switch Layout	Display	Designate whether or not to place a switch to display a [File Manager] Display on the base screen.
Switch Label	Font Type	Choose the label font for the switches.
	Display Language	Select a language for the label on the switch.
	Text Color	Select the font color that will display on the switch labels.
	Label	Enter text for the selected switch.
Switch Color	Border Color	Select a border color for the Switch. NOTE • Some settings cannot be set depending on the part that you chose with [Select Shape].
	Display Color	Set the switch color.
	Pattern	Select the switch pattern from 9 types.
	Pattern Color	Select the switch pattern color.
	Blink	Select the Part blink and blink speed. You can choose different blink settings for the [Display Color], [Pattern Color], [Border Color], and [Text Color]. NOTE • There are cases where you can and cannot set Blink depending on the Display Unit and System Settings' [Color Settings]. ☞ "8.5.1 Setting Colors ■ List of Available Colors" (page 8-42)

24.11 Mechanism of Transfer CSV Data Setup

24.11.1 How to Transfer CSV Data

The Destination Address and other information is not included in created CSV data. Set the condition necessary for transfer (Destination Address, Number of Data Items, etc.) separate from the data.

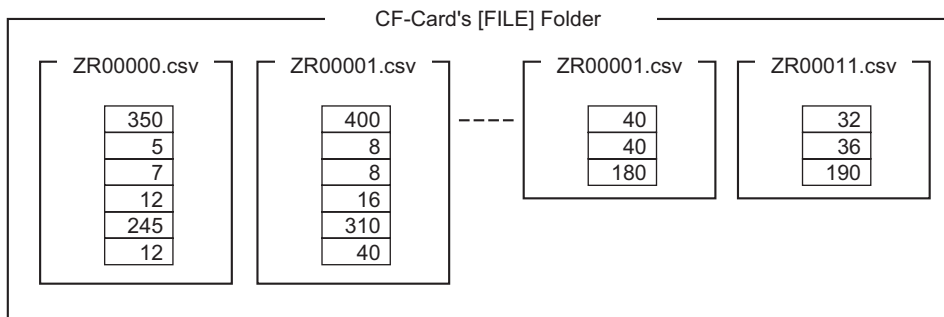

Condition Example

Collected files to be transferred to the same address are set as a single condition (GROUP). In the file name [ZR*****.csv], ***** represents the file number portion.

Condition Number	Condition Name	Address	Number of Data Items	File Number
0	Material 1	D100 -	6	0-9
1	Temp.	D110 -	3	10-19
2	Material 2	D300-	50	20-99

This is the start address for the transfer destination (or transfer source.) You can set up either the address for an external device or an internal address.

Designate the range (the start number to the termination number) of the files you want to transfer with the same condition.



When the ZR00000.csv and ZR00010.csv files are transferred to the device/PLC, ZR00000.csv is written depending on Condition Number 0, and ZR00010.csv is written depending on Condition Number 1.

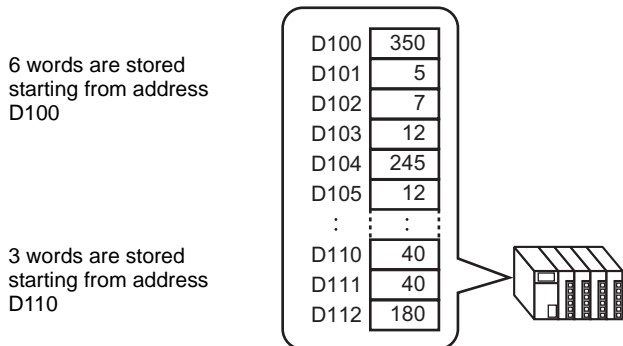

- NOTE**
- If the number of data items designated in the condition settings differs from that of the CSV Data Recipes, the smaller number of data items is transferred.
 - Ensure that the file numbers set in the condition settings ([Start] to [End]) are not repeated in multiple conditions. If file numbers are repeated in several conditions, data is transferred according to the condition with the smaller number.

Condition Number	Condition Name	File Number
0	Product A	0-3
1	Product B	2-5

The overlapping files ZR00002.CSV and ZR00003.CSV are transferred according to Condition Number 0.

- Without using preset condition settings, you can set the condition (Destination Address, Number of Data Items, etc.) at the time of transfer.
 ☞ "24.11.2 Control Word Address ◆ For Address Action" (page 24-96)

24.11.2 Control Word Address

This address controls the transfer when automatically transferring CSV data. The address contents are different when you transfer with the [Condition Action] or with the [Address Action].

◆ **For Condition Action**

Set the number of files and the file numbers to transfer. When bit 0 of the [Control Word Address] turns ON, CSV data from the CF Card/USB storage is written to the device/PLC. When bit 1 turns ON, device/PLC data is saved to the CF Card/USB storage according to the [Condition].

A maximum of 64 files can be transferred simultaneously.

Control Word Address	Control
+1	Status
+2	Number of Files (n)
+3	File Number 1
+4	File Number 2
+5	
+2+n	File Number n

- Control
Data transfers depending on the address bit 0 or bit 2 state.

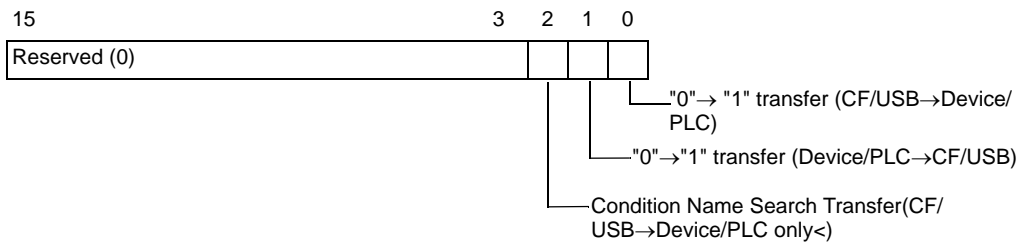

- NOTE**
- Ensure that all bits in this address are set to "0" when the GP unit is turned on.
 - Do not turn multiple bits ON at the same time.
 - The Condition Name Search transfer can only be run when using the [Condition Name Search Feature].
 ☞ "24.11.3 About Condition Name Search Feature" (page 24-101)
 - Select CF Card or USB storage.
 When you select USB storage, the Control Word Address is same.

- **Status**

Transfer state and result is reflected in this address.

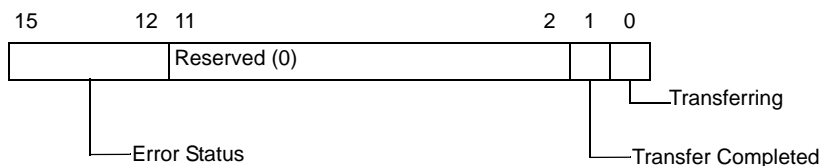

Error Codes (Reflected in the error status bits)

0	Completed Successfully	Transfer completed successfully.
1	No File Number	When transferring CF/USB→Device/PLC, the transfer destination file does not exist.
2	No Transfer Condition Number	For transfer, the Condition Number that corresponds to the specified File Number(GROUP NO) does not exist.
3	Internal Device Range Error	For a CF/USB to device/PLC transfer where the start address of the transfer is specified to the internal device, data transfer is made to an address outside the specified range of the internal device.
4	No CF Card or USB Storage	The CF Card/USB storage is not inserted in the GP, or the CF Card cover is not closed.
5	Read Error	The read-out from the CF Card/USB storage failed in the CF Card/USB storage to device/PLC data transfer.
6	Write Error	Data writing failed in the device/PLC to CF Card/USB storage data transfer, or there is not enough available space.
7	CF Card Error/USB Storage Error	The CF Card/USB storage device is invalid or the media inserted is not a CF Card/USB storage device.
8	Reserved	-
9	No Retrieve Text	No CSV file matches the retrieve text.
10	Index File Error	The index file format is incorrect.

- **Number of Files**

Specify the number of CSV files to transfer (from 1 to 64).

If this value is not set, data is not transferred when the [Control Word Address] turns ON.

Also, status will not restart.

- **File Number 1**

Stores the first File Number to transfer.

After that, the desired transfer order is stored by file number.

Automatic Transfer (Condition Action) Timing Chart

When the control address bit 0 (or bit 1) turns ON, the Transferring bit (status bit 0) turns ON.

When a data transfer is completed successfully, the Transferring bit turns OFF, and the Transfer Complete Flag (status bit 1) turns ON.

When the data transfer is complete, determine the Transfer Complete Flag via the device/PLC and turn OFF the Control Address bit.

Turning OFF the Control Address bit automatically turns OFF bit 1 (transfer complete) in the status address.

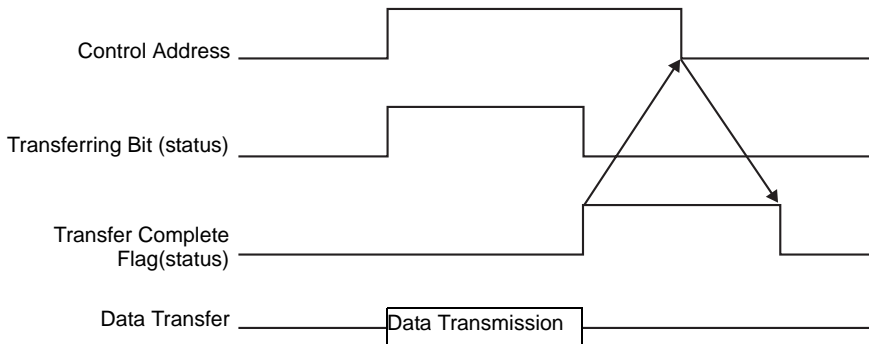

If the transfer fails, the Transferring Bit turns OFF, and the error code is set in the error status (status bits 12-15). Before starting the next transfer, clear the Status and Control bits to 0 and turn on the required Control bit.

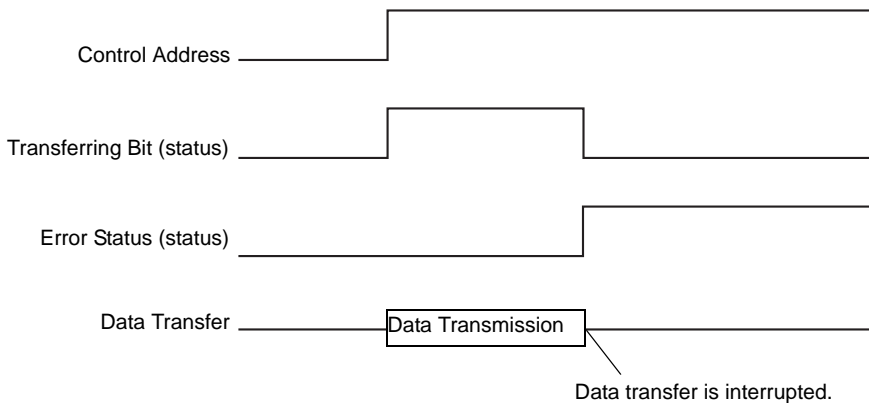

◆ **For Address Action**

The device code and address code*1 defined when transferring, also defines the transfer destination (or source) address for each CSV file.

Only one file (1 set of CSV data) can be transferred at a time.

The [Control Word Address] uses 16 consecutive words and designates the data to transfer and the destination address.

NOTE

- Even when the control address is 32 bit, the address uses 16 words.

Control Word Address	Control
+1	Status
+2	File Number
+3	Mode
+4	Address Mode
+5	Device Code
+6	Address Code
+7	(2 words)
+8	Number of Data Items
+9	Reserved Area (7 words)
+10	
+11	
+12	
+13	
+14	
+15	

After setting the file number, mode, device code, address code, and number of data, when the [Control Word Address] bit 0 turns ON, the designated file number's Recipe (CSV data) is written to the specified address.

Also, when the [Control Word Address] bit 1 turns ON, the Recipe stored in the device/PLC's designated address is saved to the CF Card/USB storage.

- Control

Data is transferred depending on the state of this address' 0 and 1 bits.

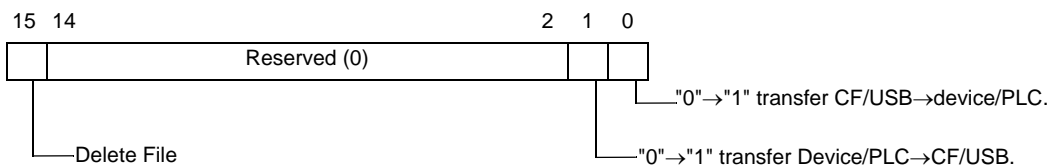

NOTE

- Ensure that all bits in this address are set to "0" when the GP unit is turned on.
- Do not turn multiple bits ON at the same time.

*1 Each device has a unique Device Code and Address Code. Refer to the "GP-Pro EX Device Manual" for more information.

If you want to specify the GP Internal Device (LS/USR), set the Address Mode to "1".

Then you can set the Device Code as follows:

LS Device: 0x0000

USR Device: 0x0001

- Status

Transfer state and result is reflected in this address.

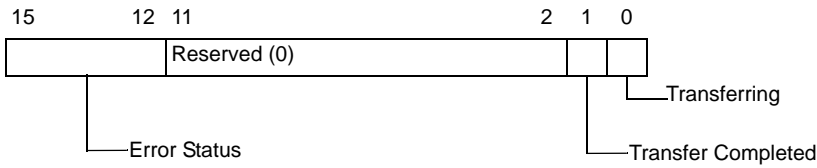

Error Codes (Reflected in the error status bits)

0	Completed Successfully	Transfer completed successfully.
1	No File Number	When transferring CF/USB→Device/PLC, the transfer destination file does not exist.
2	Reserved	-
3	Internal Device Range Error	For a CF/USB to device/PLC transfer where the start address of the transfer is specified to the internal device, data transfer is made to an address outside the specified range of the internal device.
4	No CF Card or USB Storage	The CF Card/USB storage is not inserted in the GP, or the CF Card cover is not closed.
5	Read Error	The read-out from the CF Card/USB storage failed in the CF Card/USB storage to device/PLC data transfer.
6	Write Error	Data writing failed in the device/PLC to CF Card/USB storage data transfer, or there is not enough available space.
7	CF Card Error/USB Storage Error	The CF Card/USB storage device is invalid or the media inserted is not a CF Card/USB storage device.
8	Delete Error	File delete failed, or read-only file.
9	Reserved	-
10	Reserved	-

- File

Specify the file number to be transferred.

- Mode

Set the Recipe data format to allow negative numbers.

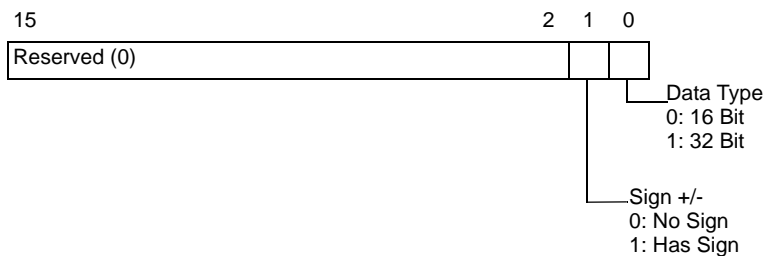

- Address Mode

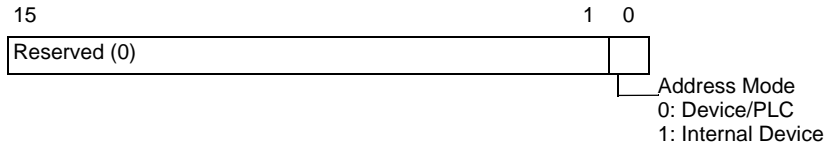

- Device code and address code
Specify the device you want to access with the Device Code. You can also specify the destination (or source) address with the Address Code.
Device and Address codes differ depending on the device. Refer to the "GP-Pro EX Device/PLC Manual" for more information. To specify the GP internal device in Address Mode, use device code 0x0000 for the LS device, and device code 0x0001 for the USR device.
- Number of Data Items
Designate the number of data items in the CSV Data Recipe. The maximum number of data items is 10,000 for 16 bit and 5,000 for 32 bit. If the number of data items exceeds this limit, the transfer operation will not work.

Automatic Transfer (Address Action) Timing Chart

When the data transfer is completed, status bit 1 (Transfer Complete Flag) turns ON. Turn OFF the trigger bit after the Transfer Complete Flag is displayed via the device/PLC. Turning OFF the trigger bit automatically turns OFF Transfer Complete Flag on the status address.

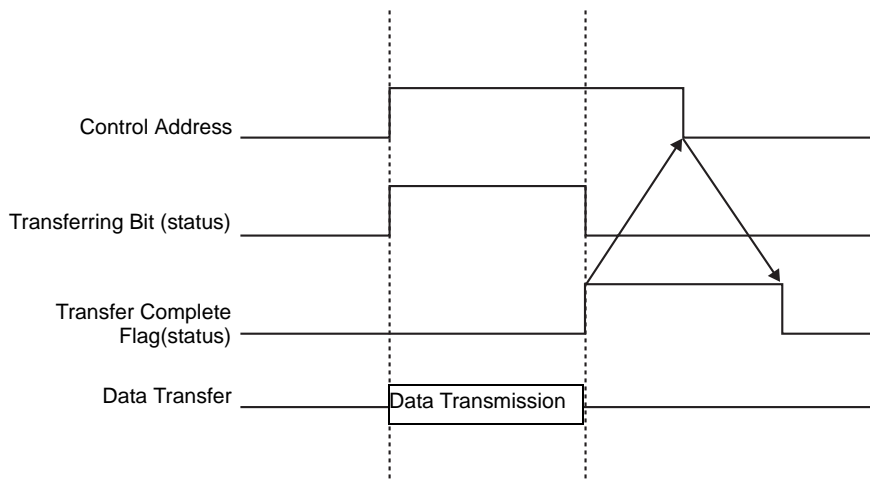

◆ **Address Action Transfer Example**

Writing from the CF Card/USB→Device/PLC

For example, Transferring "ZR00001.csv" (Number of Data Items: 6, Data length: 16 Bit, No Sign) from the CF Card to the device/PLC address D100.

Control Word Address: D50

D50	Control
D51	Status
D52	File Number
D53	Mode
D54	Address Mode
D55	Device Code
D56	Address Code
D57	(2 words)
D58	Number of Data Items
D59	
-	Reserved Area
-	(7 words)
D65	

- 1 Write the transfer file number "1" to D52.
- 2 Write "0" (16 Bit, No Sign) to D53.
- 3 Write "0" to D54.

NOTE	<ul style="list-style-type: none"> • When the transfer destination is the internal device, write "1". • For memory link type, set "0".
-------------	--

- 4 Write the transfer destination device "0x0000" (D device) to D55.
- 5 Designate the transfer destination address in D56/D57. Write "100" to D56 and "0" to D57.
- 6 Write "6" to D58.
- 7 Turn ON D50's bit 0. CSV data is written to addresses D100 to D105.
- 8 When the data transfer is completed, turn OFF bit 0 of D51(the [Transferring] bit). Turn ON the [Transfer Complete Flag] (bit 1).

◆ Reading from the Device/PLC→CF/USB

For example, transfer six data items (Data Length: 16 Bit, No Sign) from the device/PLC, D100 to D105, to the CF Card and create the file ZR00002.csv.

- 1 Write the file number "2" to be created by transfer to D52.
- 2 Write "0" (16 Bit, No Sign) to D53.
- 3 Write "0" to D54.
- 4 Write the transfer source device "0x0000" (D device) to D55.
- 5 Designate the transfer source address in D56/D57. Write "100" to D56 and "0" to D57.
- 6 Write "6" to D58.
- 7 Turn ON D50's bit 1. The data from D100 to D105 are read and the file name "ZR00002.csv" is created in the CF Card [File] folder.
When the data transfer is completed, turn OFF bit 0 of D51(the [Transferring] bit). Turn ON the [Transfer Complete Flag] (bit 1).

NOTE

- When transferring from device/PLC to CF/USB, the CSV Data date is set in the two-digit format.
-

Delete File

For example, Delete file name "ZR00002.csv" from the CF Card.

- 1 Write the file number "2" to delete to D52.
- 2 Turn ON D50 bit 15 (Deletion bit).
When the file deletion is completed, D51 bit 1 (Transfer Complete Flag) turns ON.

24.11.3 About Condition Name Search Feature

When transferring from CF/USB→device/PLC, by designating the condition name of the file you want to transfer, you can search for a matching CSV file within the CF Card/USB storage [FILE] folder and transfer that data to the device/PLC.

In the following picture, the CSV files that match the product number (condition name) read from the barcode reader are transferred to the device/PLC.

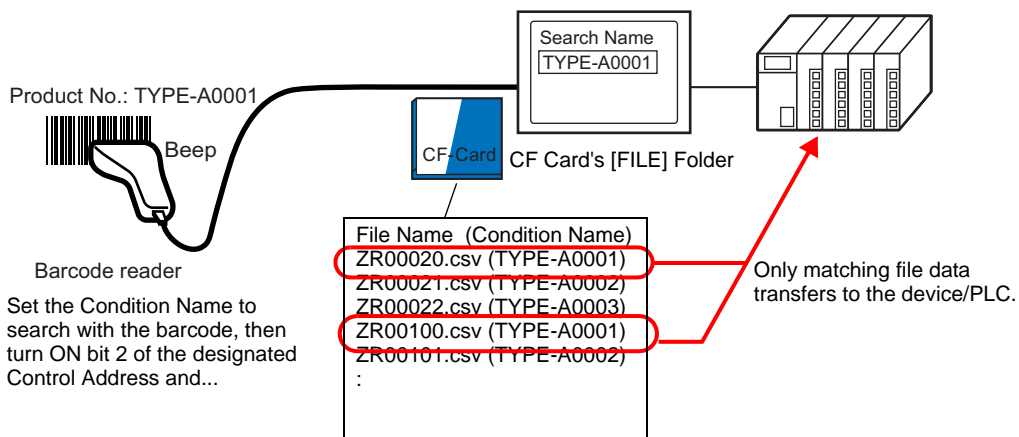
NOTE

- The search only detects files whose condition name is an exact match for the search string. Spaces indicate different file names and can cause errors.

The designated [Search Word Address] uses 16 words, and the condition name to be searched can be up to 32 characters. After storing the search condition name, turn ON bit 2 of the [Control Word Address]. The search and transfer to the device/PLC begins. If there are multiple matching files, the CSV data are transferred in order of file number.

☞ " ◆ Control Word Address when Using the Condition Name Search Feature" (page 24-103)

☞ " ◆ Condition Name Search Storing Methods" (page 24-105)

If an index file (ZRINDEX.CSV) exists in the CF Card's [FILE] folder, the search scans the contents of the index file.

If there is no index file and the [File] folder contains a large number of files, referencing and searching the condition names of all CSV files may take a long time. For example, if approximately 1,000 CSV files are searched, the search operation takes approximately one minute.

IMPORTANT

- Even if the target file exists in the CF Card [FILE] folder, files whose condition name is not reflected in the index file can not be detected. Either update or delete the index file and then transfer the files.

◆ What is Index File?

In GP-Pro EX, create CSV data and click Search File. In the [FILE] folder an index file (ZRINDEX.csv) is created.

When using the Condition Name Search feature, this file is used to speed up the search. The File Number and Condition Name for the CSV data recipes in GP-Pro EX are written to this file.

The index file has the following format:

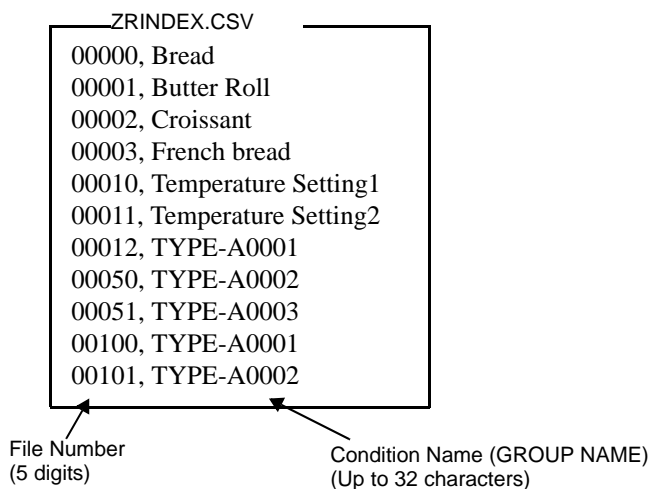

In GP-Pro EX, after you run CSV file operations such as adding, editing, or deleting from the Recipe [Transfer CSV Data (CSV File List)] command, click [Search File] to update the index file.

If a CSV file has been created in Excel or by a device/PLC and transferred to the CF card or USB storage, the index file will not reflect information from those files. Either open the index file and input the information directly in the file, or add/edit the index file in GP-Pro EX.

NOTE

- When editing the index file, do not create any index file errors. Condition Name Search feature will fail. In such cases, create a new index file or delete the existing index file before resuming the transfer operation. The index file can be deleted by using a Special Data Display [File Manager].
 - (1) A file number is missing.
 - (2) The file number is not within the range of 0 to 65,535.
 - (3) The index file is not in CSV file format.
- The index file condition names and file numbers are created by referencing all the saved files in the [File] folder. It is not created using GP-Pro EX's condition settings.

◆ **Control Word Address when Using the Condition Name Search Feature**

After storing the Condition Name to search, turn the [Control Word Address] transfer bit (bit 2) from OFF to ON to: search for CSV files within the CF Card/USB storage and transfer all CSV files that match the search condition name.

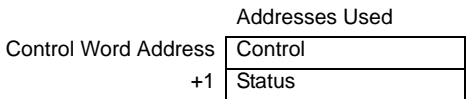

• Control

When bit 2 turns ON, search for the file with the condition name that matches the text string designated in [Search Word Address], and write the matching CSV data to the PLC.

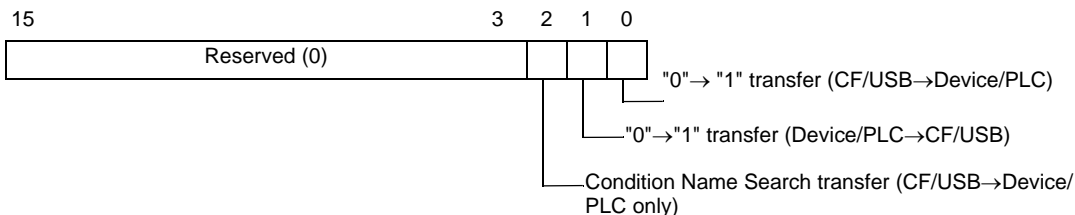

- NOTE**
- Ensure that all bits in this address are set to "0" when the GP unit is turned on.
 - When bit 0 (CF/USB→Device/PLC) and bit 2 (Condition Name Search transfer) turn ON at the same time, neither operation is performed. Turn ON only bit 2.

• Status

Transfer state and result is reflected in this address.

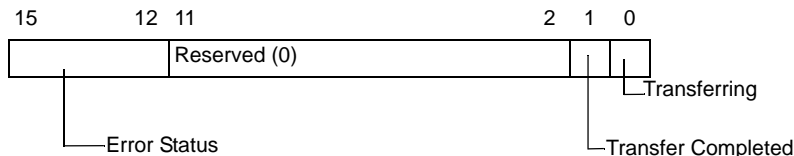

Error Codes (Reflected in the error status bits)

0	Completed Successfully	Transfer completed successfully.
1	No File Number	When transferring CF/USB→Device/PLC, the transfer destination file does not exist.
2	No Transfer Condition Number	For transfer, the Condition Number that corresponds to the specified File Number(GROUP NO) does not exist.
3	Internal Device Range Error	For a CF/USB to device/PLC transfer where the start address of the transfer is specified to the internal device, data transfer is made to an address outside the specified range of the internal device.

Continued

4	No CF Card or USB Storage	The CF Card/USB storage is not inserted in the GP, or the CF Card cover is not closed.
5	Read Error	The read-out from the CF Card/USB storage failed in the CF Card/USB storage to device/PLC data transfer.
6	Write Error	Data writing failed in the device/PLC to CF Card/USB storage data transfer, or there is not enough available space.
7	CF Card Error/USB Storage Error	The CF Card/USB storage device is invalid or the media inserted is not a CF Card/USB storage device.
8	Reserved	-
9	No Retrieve Text	No CSV file matches the retrieve text.
10	Index File Error	The index file's CSV format is incorrect.

Condition Name Search Transfer Timing Chart

When the control address' bit 2 turns ON, the [Transferring] bit (status bit 0) turns ON. When a data transfer is completed successfully, the Transferring bit turns OFF, and the Transfer Complete Flag (status bit 1) turns ON.

When the data transfer is completed, determine the Transfer Complete Flag via the device/PLC and turn OFF the Control Address' bit. When the trigger is OFF, the [Transfer Completion] bit turns OFF.

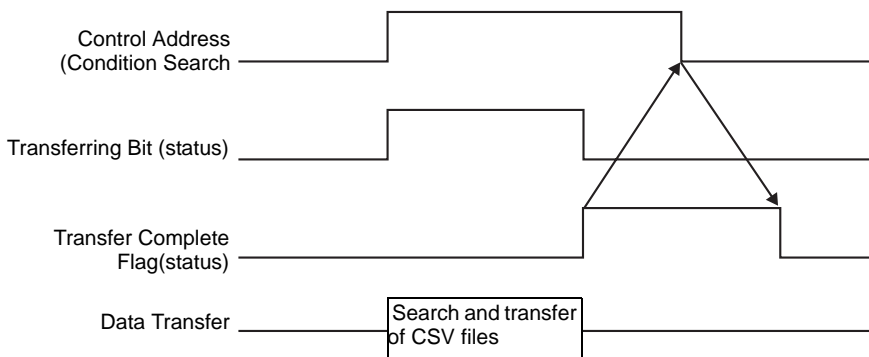

If the transfer fails, the Transferring Bit turns OFF, and the error code is set in the error status (status bits 12-15). Before starting the next transfer, clear the Status and Control bits to 0 and turn on the required Control bit.

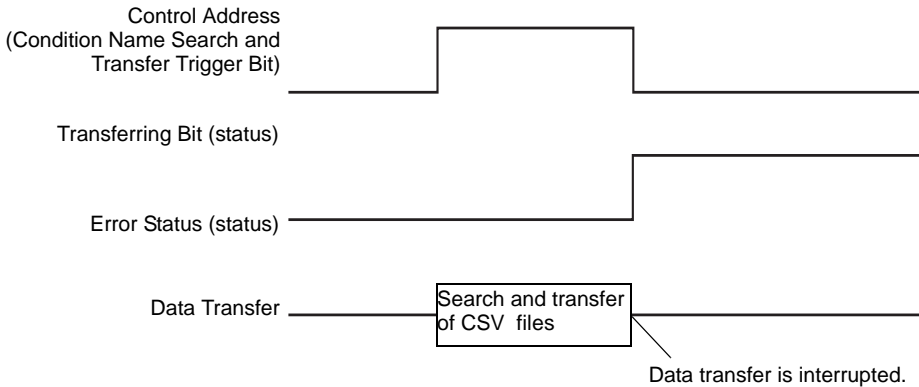

NOTE

- The period during which the Transferring Status Bit is ON includes the time required for the search of the CSV files. Therefore, do not access the [FILE] folder in the CF Card/USB storage while the Transferring Bit is on.

◆ Condition Name Search Storing Methods

In the lower 16 words of the designated [Search Word Address], you can store the condition name according to the Text Data Mode. This can be set to either a device/PLC address or GP internal device address.

If the specified name is less than 32 characters, write 0 (NULL="0(h)") or a blank space in the address following the last character. Characters before the address containing 0 (NULL="00(h)") are considered as the condition name for the search.

Condition Name Search can be performed only for Data Modes 1, 2, 4 or 5.

The following are examples of the Text Data Modes.

For example, searching for Condition Name "TYPE-A0001".

- Text Data Mode 1

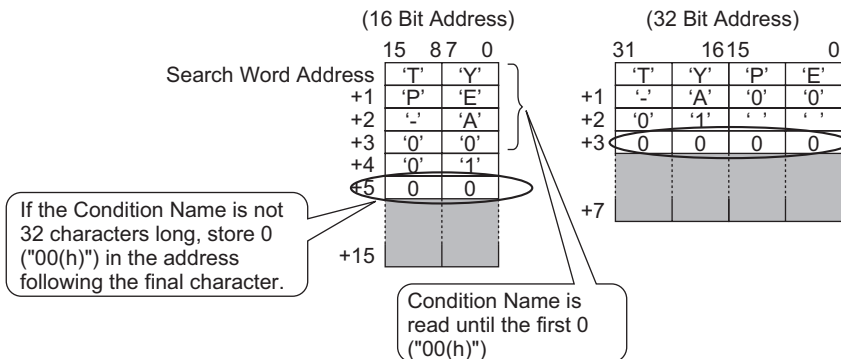

- Text Data Mode 2

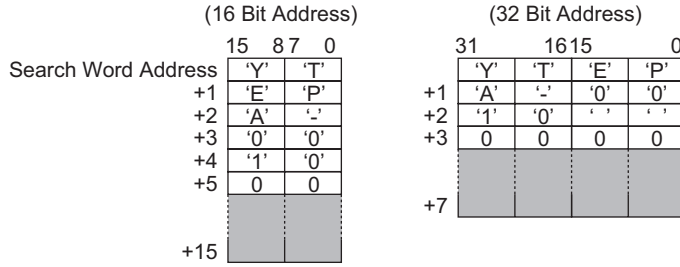

- Text Data Mode 4

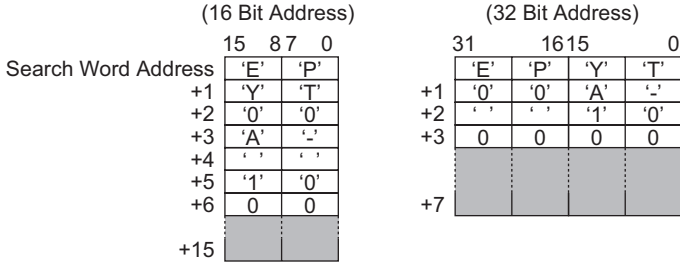

- String Data Mode 5

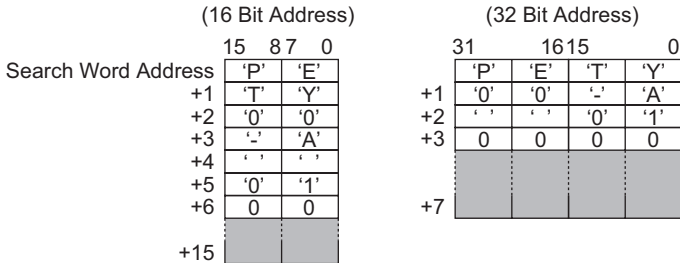

IMPORTANT

- You can use a space in the condition name to search, but it can not be in the last position. Spaces between the last character and 0 are replaced with 0 in the matching operation.
- If the [Search Word Address]'s top position is 0, the search looks for a file without a condition name.

24.11.4 About Automatic Numbering

When automatically transferring from the device/PLC to the CF Card or USB storage device, you can automatically allocate file numbers to create new files. To set up this function, open the [CSV Data Transfer Condition] dialog box and click the [Extended] tab.

The automatic numbering action is as follows:

- The new file name is created by adding +1 to the file number with the most recent time stamp among existing files on a CF card/USB storage.
- If no free space is left, the file with the oldest time stamp is deleted and a new file is created by adding +1 to the last saved file number.

ZR00000.CSV	9:00
ZR00001.CSV	10:00
ZR00002.CSV	11:00



ZR00001.CSV	10:00
ZR00002.CSV	11:00
ZR00003.CSV	12:00

If files numbered from "ZR00000.CSV" to "ZR00002.CSV" exist, "ZR00000.CSV" is deleted to create "ZR00003.CSV".

- When the file numbers saved to the CF Card/USB storage device are not sequential, the new file name is created by adding +1 to the file number with the most recent time stamp among existing files.

ZR00000.CSV	9:00
ZR00001.CSV	10:00
ZR00003.CSV	11:00



ZR00000.CSV	9:00
ZR00001.CSV	10:00
ZR00003.CSV	11:00
ZR00004.CSV	12:00

When the ZR00002.CSV file has not been saved and the ZR00003.CSV file is still new, the application generates ZR00004.CSV.

NOTE

- If the file numbers do not conform to time stamps in automatic numbering mode (when files are overwritten by manual transfer), a new file is created by increasing the most recent File Number by +1.

ZR00000.CSV	10:00
ZR00001.CSV	12:00
ZR00002.CSV	11:00
ZR00003.CSV	9:00



ZR00000.CSV	10:00
ZR00001.CSV	12:00
ZR00002.CSV	13:00
ZR00003.CSV	9:00

When files ZR00000.CSV to ZR00003.CSV already exist, ZR00002.CSV becomes overwritten with a new file.

- When using automatic numbering, do not use manual transfer and allocate file numbers (Device/PLC to CF/USB). These files will be overwritten. Regardless of the timestamp of a manual transfer, files are overwritten, in order, from the number of the last automatically numbered file plus one. If the file number reaches the [End], data will not be transferred even if the [Control Word Address] turns ON. To continue transferring data, use the [Loop] feature or specify the [Resume Bit Address].

- Using the Loop function

When you enable the [Loop] feature, after the [End] is reached, data is overwritten starting from the [Start] and the transfer continues.

For example, when the Condition are: [Start] = 0, [End] = 4

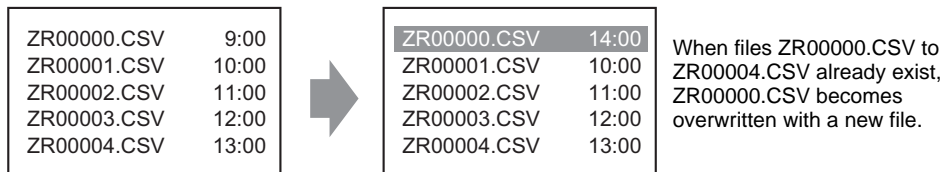

- When using a Resume Bit Address

When the [End] is reached and the designated [Resume Bit Address] turns ON, then the next time the [Control Word Address] turns ON. The [Start] file gets overwritten and the other files after that are overwritten and transferred.

Automatic Numbering Timing Chart

When you create files from [Start] to [End], the [Full Bit Address] turns ON and automatic transfer ends.

To run automatic transfer again, turn ON the [Resume Bit Address], then turn ON bit 1 of the [Control Word Address]. Files are overwritten and created in order starting from the [Start]. When the [Resume Bit Address] turns ON, the [Full Bit Address] is turned OFF. Check that the [Full Bit Address] is turned OFF and turn OFF the [Resume Bit Address].

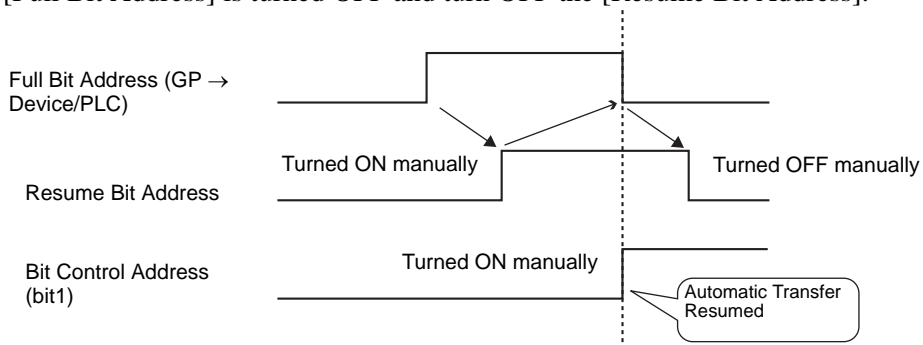

- NOTE**
- Transfer may not work when files already exist up to the end number in the CF Card or USB storage. When the GP is turned ON, right after turning ON bit 1 in the [Control Word Address], the [Full Bit Address] turns ON. However, if the [Resume Bit Address] is ON, when you turn ON bit 1 in the [Control Word Address], files are overwritten beginning at the start number. Before you run the Transfer operation, you should check the file number stored on the CF card or USB storage, and also check the state of the [Resume Bit Address].

24.12 Mechanism of Filing Data Transfer

24.12.1 Filing Data Structure

Recipe data is managed in folder units.

One folder can hold a maximum of 2,048 files.

One file can handle a maximum of 1,650 blocks (recipes). Data transfer is carried out in blocks. Also, the maximum number of data items in 1 file is 10,000 or 5,000 when the data is 32 bit.

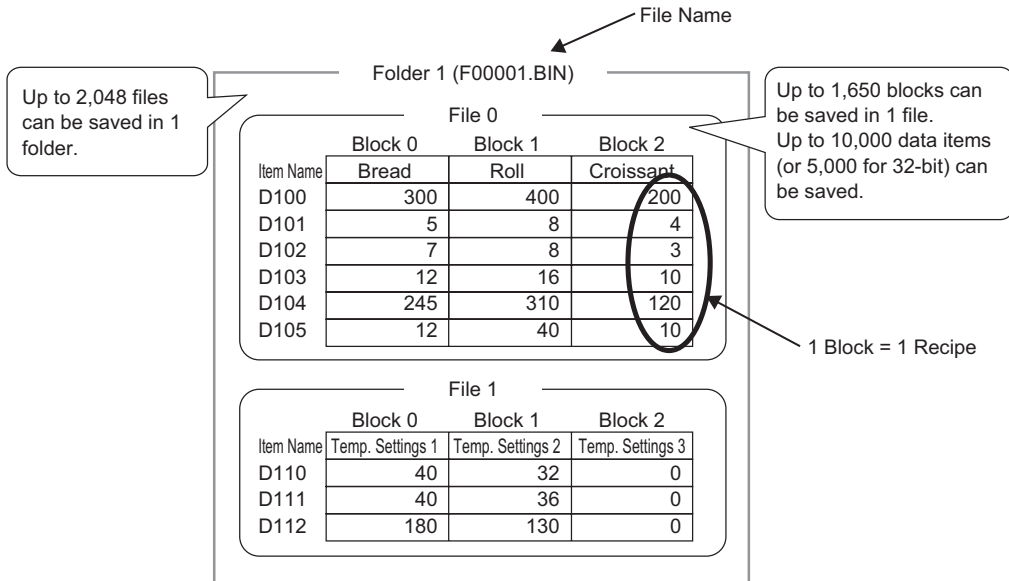

NOTE

- The number of files, blocks, and data that can be set changes depending on the ratio of each one.
- You can also register files in multiple folders. Up to 8,999 folders can be registered, but only one folder can be stored in backup SRAM.

Transfer Preparation when using Multiple Folders

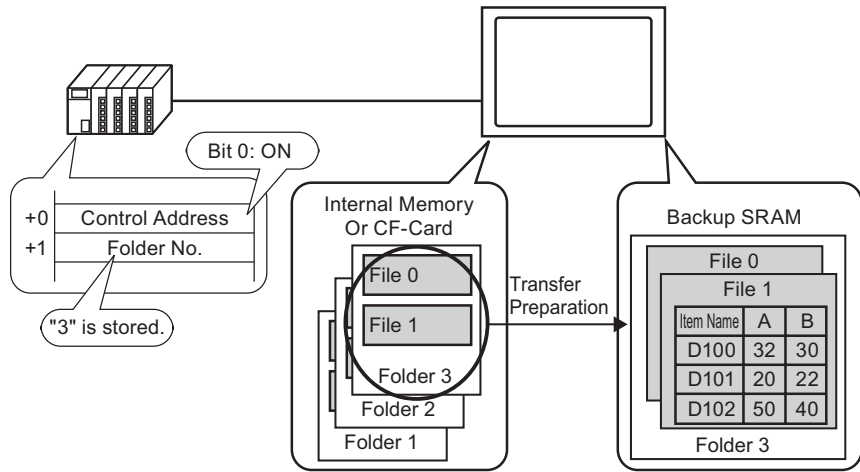

■ **About Backup SRAM**

This memory will save data even when the GP unit is OFF.

The backup SRAM user area is used to back up filing data, Alarm History data, Sampling data, and the internal device (User Area).

The capacity of backup SRAM that can be used by filing data depends on the model of GP and how much capacity is being used by other data.

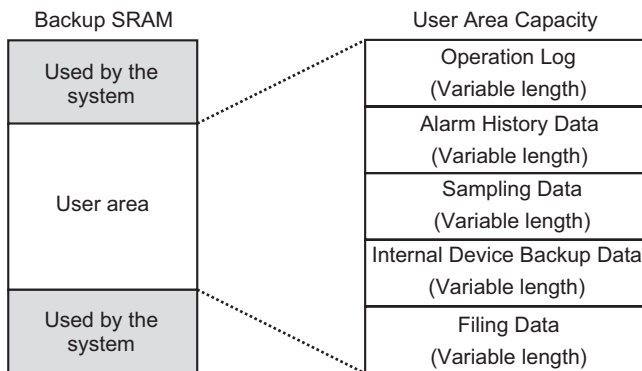

The backup SRAM user area has the following usage priorities:

- (1) Operation Log data
- (2) Alarm History data
- (3) Sampled data
- (4) Internal Device backup data
- (5) Recipe Data

IMPORTANT

- Data in backup SRAM is erased when:
Screen transfer occurs
The user area is initialized (Offline)
Backup SRAM is initialized (Offline)
- Data stored in backup SRAM can be saved to a CF Card/USB storage device. To set this option, from the System Settings, select [Display Unit], select the [Action] tab, then select [Data Storage]. For more information, see  " ◆ Operation" (page 5-134)

◆ Filing Data Capacity

The maximum storage capacity of filing data per file is the maximum capacity of the backup SRAM user area. Folder capacity is calculated in the following way, depending on the number of files, blocks, data, and the bit length.

Calculation

- Usage capacity per file (in bytes)

$$118 + \{(68 + 2^{*1} \times \text{Number of Data Items}) \times \text{Number of Blocks}\}$$

*1 2 bytes when the data length is 16 bit, 4 bytes when the data length is 32 bit.

- Usage capacity per folder (in bytes)

$$4 + \text{the sum of each file's volume}$$

Calculation Example

Function	Description
Blocks	5
Number of Data Items	1000
Data format (bit length)	16 Bit

For example, folder capacity with only 1 file

[Calculation result]

$$4 + [118 + \{(68 + 2 \times 1,000) \times 5\}] = 10,462 \text{ bytes (around 10 KB)}$$

24.12.2 Transferring Item Name and Block Number

In the [Edit Filing Data] > [Option], you can configure settings to transfer data with the item name and block number attached to it.

When transferring both the item name and block number to the device/PLC along with the data, it is stored with the following structure.

For example, [Storage Start Address] is a 16 bit address, data is 16 bit

The screenshot shows the 'Edit Filing Data' dialog box with the following settings:

- File Number: 0
- Comment: Ingredient
- Storage Start Address: [PLC1]D00126
- Number of Blocks: 3 (1 - 1650)
- Display Format: Dec
- Bit Length: 16 Bit
- Language: ASCII

The table in the dialog box shows the following data:

ItemName	Block 0	Block 1	Block 2
[PLC1]D00126	Bread	Butter Role	Croissant
[PLC1]D00127	350	400	200
[PLC1]D00128	5	8	4
[PLC1]D00129	7	8	3
[PLC1]D00130	12	16	1
[PLC1]D00131	245	310	10
[PLC1]D00132	12	40	1

The diagram shows the storage structure in a Device/PLC:

- Block No. (1) is stored in D110-D111.
- Item Name (32 characters) is stored in D126-D128.
- Data is stored in D129-D132.

IMPORTANT

- The item name's text is stored according to the Text Data Mode settings.*1
- Storage of the item name and data depends on the designated [Storage Start Address] and [Bit Length].
- The block number is not transferred during a device/PLC→SRAM transfer. The same applies when transferring via the internal device (Device/PLC → Internal Device →SRAM).
- When using manual transfer via the internal device, the item name will be sent between the SRAM and the internal device regardless of settings in the [Preferences] dialog box.

For example, when only [Send Block Number] is designated

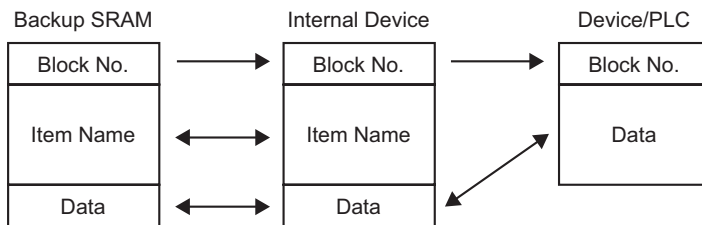

NOTE

- When the Item Name is less than 32 characters, spaces are automatically appended.
- Even when the [Display Format] is set to [BCD], the Block Number are stored in the device/PLC with binary data.

*1 Text Data Mode settings are configured in the System Settings [Device/PLC].

Data Structure when Transferring both Block Number and Item Name

- When [Storage Start Address] is a 16 bit address ($n = \text{Number of Data Items}$)

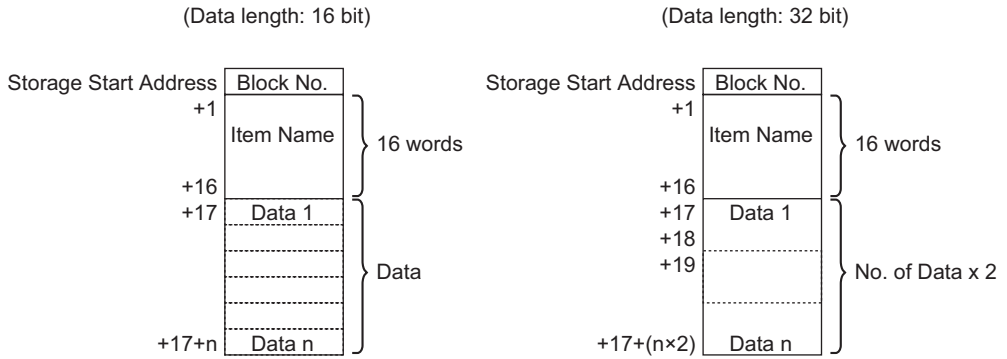

- When [Storage Start Address] is a 32 bit address ($n = \text{Number of Data Items}$)

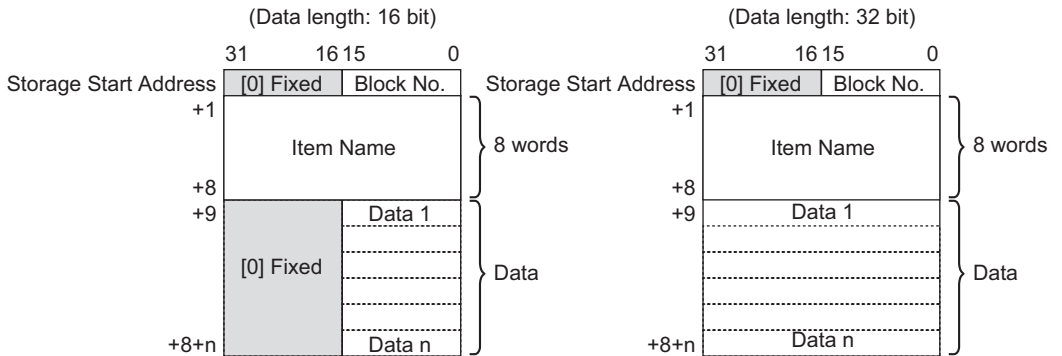

24.12.3 Manual Transfer Via the Internal Device

When a Special Data Display [Filing] is set with [Via Internal Device], you can use a Switch Lamp (select [Special Switch] and point to [File Item Switch]) for the following transfers:

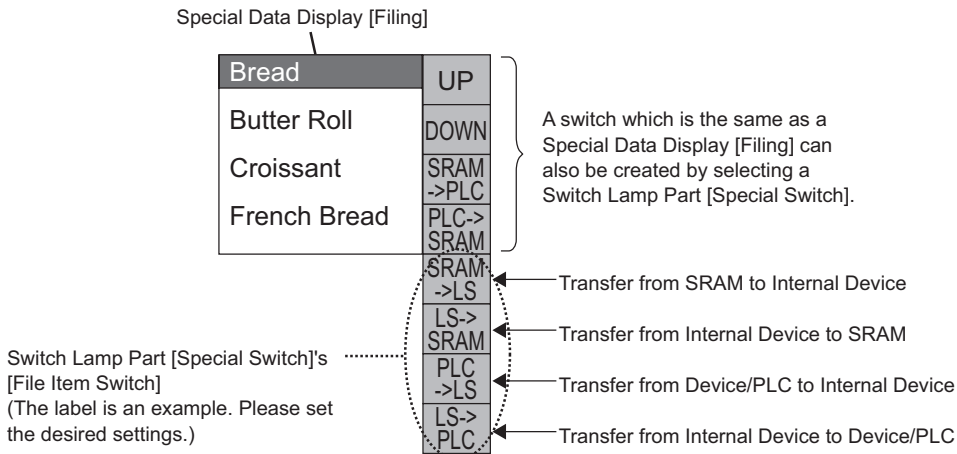

NOTE • A Switch to operate the transfer to and from the internal device can only be created with a Switch Lamp [Special Switch].

For example, when transferring from SRAM → Internal Device (Start Address: LS20) → Device/PLC
(Data length: 16 Bit)

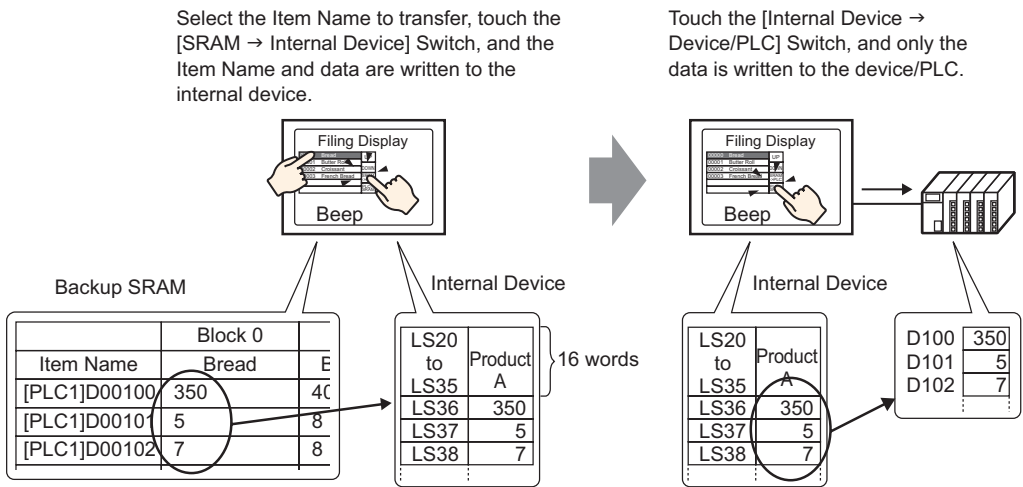

Data stored in the internal device can display as required on the GP screen in a Data Display [Numeric Display]. Use this when you want to want to make small adjustments to the data on the GP screen before transferring it to the device/PLC.

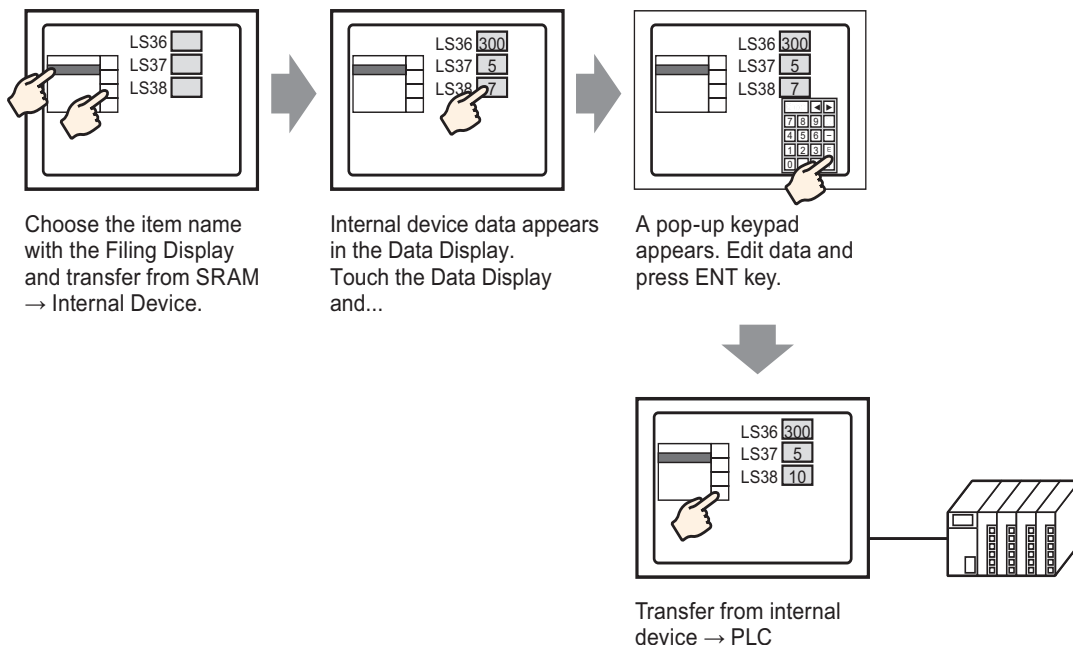

◆ Structure of Filing Data Stored in the Internal Device

When transferring data from backup SRAM → the internal device, the 16 consecutive words after the designated [Storage Start Address] store the item names, and data are stored after that.

The item name will be stored according to the Text Data Mode settings.*1

For example, when data is 16 bit:

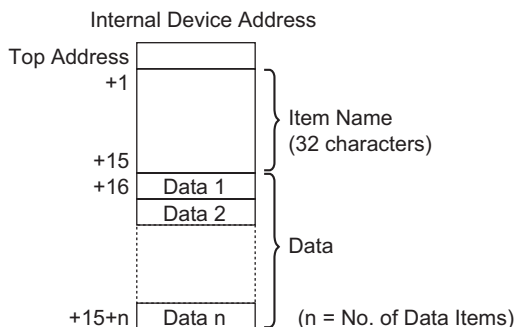

NOTE • When data is 32 bit, the used data portion is Number of Data Items x two words.

*1 Text Data Mode settings are configured in the System Settings [Device/PLC].

When transferring data from the internal device → the device/PLC, only data stored in the internal device are written to designated addresses in the device/PLC.

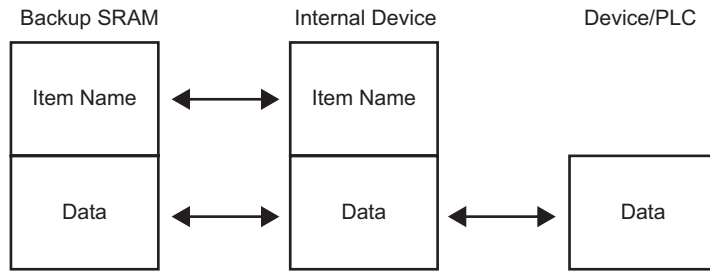

NOTE

- If [Send Item Names] is set when creating data, you can also transfer item names to the device/PLC.

☞ "24.12.2 Transferring Item Name and Block Number" (page 24-112)

24.13 Restrictions

24.13.1 Restrictions on Transferring CSV Data

- The maximum number of data that can be set in one file (ZR*****.csv) is 10,000 (or 5,000 when the data is 32 bit).
- If the number of data is large, transfer may take some time. The time between transfer start and transfer end can be from several seconds to several minutes.
- While a transfer is occurring, the display of Parts may not update properly or may become slow. Screen changes and other operations may also be delayed.
- If a screen change occurs during transfer, in order to read the screen information, the transfer may take some time.
- Wait until a transfer completes before initiating another one. If a transfer is started before the previous one ends, such as when an automatic transfer and manual transfer occur at the same time, the second transfer operation may not be accepted.
- Only the selected CF Card or USB storage device will operate.
- If multiple files are stored in the CF Card/USB storage [File] folder, transferring from the device/PLC to the CF/USB, may take up to several minutes.
- The state of the CF Card/USB storage must be stored on the display unit to use the CSV data transfer screen. If this state is not stored, the transfer may not work properly.
- When a CF Card/USB storage error occurs, the writing state file may remain on the CF Card/USB storage device.
- When overwriting, the required available space on the CF Card or USB Storage is at least double the size of the actual data. If there is more data than available space, a write error occurs during transfer. To free up space, you can move out data that is not needed immediately between the CF Card and USB Storage. If the data exceeds the free space, a write error occurs when it is transferred.
 "A.5 Transferring Data Between a CF Card and a USB Memory Device" (page A-90)
- When transferring data from device/PLC to CF/USB, the [File] folder is created if it does not already exist. If the CF Card/USB storage is not reset or the folder cannot be created, a CF Card/USB storage error occurs.
- When you save the existing CSV data in the CF Card/USB Storage, if there is data entered in the third row or later in the CSV data, it will be deleted.
- The number of times that data can be written on a CF Card is limited. (Approximately 100,000 times for rewriting 500 KB.)
- When saving data in a CF Card, you cannot use a file name or folder name with two-byte characters. The file name/folder name should be 8 single-byte characters or less.
- To format the CF Card/USB storage on your PC, select FAT or FAT32. If you use NTFS for formatting, GP does not recognize the CF Card/USB storage.

- Do not connect more than 1 USB storage. If you do so, the USB devices may not be recognized properly.
- When using Float, up to 17 digits or 16 decimal places can be read, but an error may occur after the seventh digit due to floating point limitations.
- When transferring from the CF card or USB storage to the device/PLC, tabs and single-byte space characters are skipped when read. Furthermore, when there are periods or commas in comments, there are instances when the data text cannot be read properly. When there are two or more commas in a single row, data after the second comma is not read.

■ Precautions for CF Card Handling

- When ejecting a CF Card, make sure that the CF Card access LED lamp turns OFF. Otherwise, the data on the CF Card may be damaged.
- When accessing a CF Card, be sure not to power OFF or reset the GP, or eject the CF Card. Create an application screen on which the CF Card cannot be accessed, and on that application screen, you may power OFF or reset the GP, open and close the CF Card cover, and eject the CF Card.
- When inserting a CF Card, check the front and back sides and the connector position of the card. If the CF Card is inserted the wrong way, the data, the CF Card, or the GP may be damaged.
- Use a CF Card manufactured by Digital Electronics Corporation. If a CF Card manufactured by another company is used, the contents of the CF Card may be damaged.
- Please make sure to back up all CF Card data.
- Please refrain from doing the following, as it can result in damage to data and equipment:
 - Bending the CF Card
 - Dropping the CF Card
 - Spilling water on the card
 - Touching the CF Card's connectors directly
 - Disassembling or modifying the CF Card

■ USB Storage Usage Cautions

- While accessing the USB storage device, do not reset the GP insert or remove the USB storage device. The data on the storage device may be corrupted.
To remove the USB storage device safely, design the system so that the device is removed after turning ON the System Variable #H_Control_USBDetachTrigger and confirming that the #H_Status_USBUing is OFF.
 "A.6.2 HMI system variables (#H system variables) ■ Bit type" (page A-116)
- Please make sure to backup the data on the USB storage device.

■ Restrictions for Manual Transfer

- First set the Condition on [Recipe] - [Transfer CSV Data (Condition)], then place the Special Data Display [Data Transmission] on the screen.
- Only one Special Data Display [Data Transmission] can be placed per screen.
- Up to 32 Special Data Display [Data Transmission] can be placed per project.
- When selecting transfer files by touch, multiple files can only be selected from the area displayed in a Special Data Display [Data Transmission]. (The maximum number of display rows is 50.) If the displayed page changes with the scroll switch, the selection cancels.
- If an error occurs while multiple files are being transferred, the transfer of subsequent files stops.
- When transferring data from the device/PLC to the CF/USB, the data is saved in the file set in the Special Data Display [Data Transmission]. The Condition Name (Group Name) is overwritten by the Condition Name set in the Common Settings - Condition area.
- If the number of data designated in the condition settings differs from that in the file, the smaller number of data are transferred.
- Ensure that the file numbers set in the condition settings ([Start] to [End]) are not repeated in multiple conditions. If file numbers are repeated in several conditions, data are transferred according to the condition with the smaller number.

■ Restrictions on Automatic Transfer (Conditional Action)

- A maximum of 64 files can be transferred at one time.
- If an error occurs while multiple files are being transferred, the transfer of subsequent files is stopped. Transfer occurs in order starting from the top file number storage address.
- If the number of data designated in the condition settings differs from that in the file, the smaller number of data are transferred.
- Ensure that the file numbers set in the condition settings ([Start] to [End]) are not repeated in multiple conditions. If file numbers are repeated in several conditions, data are transferred according to the condition with the smaller number.
- If the number of files is not set, data are transferred even when the [Control Word Address] turns ON. Also, status will not restart.
- When transferring data from device/PLC to CF/USB, the [File] folder is created if it does not already exist. If the CF Card/USB storage is not reset or the folder cannot be created, a CF Card/USB storage error occurs.

■ Restrictions on Automatic Transfer (Address Action)

- One CSV Data Recipe can be transferred at a time.
- When transferring CSV Data Recipes from CF/USB to device/PLC using a memory link connection, set the [Address Mode] to "0".
- If the number of data exceeds the set range (10,000 when the data length is 16 bit, 5,000 when it's 32 bit), any excess values are not transferred.
- Ensure that the device code/address code is set correctly. If the device address is out of range or refers to a non-existent device, a communication error occurs and the screen freezes.

If a communication error occurs while transferring from device/PLC to CF/USB, correct the device code/address code. Turn ON bit 1 of the [Control Word Address] again. If the error occurs while transferring from CF Card /USB to device/PLC, turn the power to the GP OFF then ON.

- When transferring data from device/PLC to CF/USB, the [File] folder is created if it does not already exist. If the CF Card/USB storage is not reset or the folder cannot be created, a CF Card/USB storage error occurs.

24.13.2 Restrictions on Displaying/Editing/Printing CSV Data

■ Restrictions on Displaying

- Only one Special Data Display [Show CSV] can be placed per screen.
- Only one Special Data Display [File Manager] can be placed per Base Screen. It cannot be placed on a Window Screen.
- When you place a Special Data Display [Show CSV] on a Window Screen, you cannot edit the data. The editing screen cannot be triggered.
- You cannot set a Special Data Display [Show CSV] at the same time as a Sampling Data Display or Data Display (a Numeric Display with [Allow Input] set or a Text Display).
- The Special Data Display [File Manager] cannot be scaled up or down.
- When placing a Special Data Display [File Manager], specify the X coordinate in 4-dot increments. If you place it in a different position, it will not be displayed in the exact position it was on the screen in GP-Pro EX because the GP corrects the display position.
- You can display the Special Data Display [File Manager] part using a Special or Local Window. If the maximum number of windows is already displayed, first close one of the other windows to display the File Manager.
☞ "12.8 Restrictions for Windows" (page 12-29)
- To access CSV data in the USB storage device, use the Special Data Display - File Manager part.
- When a text table changes, the Special Data Display - File Manager is closed.
- If more than one display switch for a Special Data Display - File Manager is set up on a single screen, only one File Manager functions. Touching another display switch while a File Manager is already displayed closes the File Manager window currently displayed.
- Files currently displayed on a Special Data Display - Show CSV cannot be deleted with a Special Data Display - File Manager.
- When updating by transfer from the device/PLC to CF/USB, the displayed CSV file data is updated and rewritten.
- If the cover of the CF Card slot is open or the USB storage device is removed while CSV file data is displayed, the display is cleared.
- If the screen changes while CSV data is displayed, the display is cleared.
- There are two valid data formats for CSV data displayed in a Special Data Display [Show CSV]: data delimited by double quotation marks [""], and data separated by commas [.,].

For example, CSV format (Sampling data)

```
"", "Date", "Time", "Data 0", "Data 1"
"Number1", "01/12/05", "09:00:00",
"123.4", "780"
"Number2", "01/12/05", "10:00:00",
"213.5", "235"
```

```
,Date,Time,Data0,Data1
Number 1, 01/12/05, 09:00:00, 123.4,
780
Number 2, 01/12/05, 10:00:00, 213.5,
235
```

■ Restrictions for Editing

- The editing screen for a Special Data Display [Show CSV] displays via a Special or Local Window. If the maximum number of windows already display, the editing screen cannot be activated. Close another window before editing the data.
☞ "12.8 Restrictions for Windows" (page 12-29)
- You can edit up to 56 characters in a Special Data Display [CSV Display]. This limit depends on the model and orientation.
- If you try to save data to the CF Card or USB storage device during an edit operation, a write error will occur. Data cannot be saved while editing.
- If data are changed during editing, a CF write error occurs and is stored in the [Status Address]. The displayed data are not updated.
- When a text table changes, the editing screen will be automatically closed.
- Even when the [Interlock Address]'s state matches the [Touch Enable Condition] during editing, editing can be performed. However, if editing is attempted again, the screen will not enter Edit mode because the Interlock feature is enabled.
- Numeric values displayed on a Special Data Display [Show CSV] are displayed as text. Therefore, the inputs are edited regardless of properties such as the number of display digits, data length, and data type.
- While the edited data is being output to a CSV file, printing and editing modes are disabled. Also, the system cannot be moved to off-line mode.
- Regardless of the Show Column settings, the column portion cannot be edited.
- When editing data, a temporary file is created on the CF Card/USB storage device equivalent to the size of the file being edited. You cannot edit a file unless free space the size of the file or larger is available on the CF Card/USB storage device.
When editing data, the internal processing updates the file in the following way:
For example, when editing "ZR0001.CSV"
 - (1) After editing and pressing the [ENT] key, a temporary file (a file that reflects the editing results), "_CSV\$\$_0.TMP" is created.
 - (2) The original file name is changed from "ZR0001.CSV" to "_CSV\$\$_1.TMP"
 - (3) "_CSV\$\$_0.TMP" is changed to "ZR0001.CSV"
 - (4) "_CSV\$\$_1.TMP" is deleted.If the power turns OFF during editing or if editing fails, temporary files may remain on the CF Card/USB storage.
- When a Special Data Display [Show CSV] is rotated by 90 or 180 degrees, the editing screen characters are not displayed properly. To place a rotated [Show CSV], set rotation to 0 or 270 degrees.

■ Restrictions for Printing

- The horizontal lines are not printed.
- Any portion that exceeds an A4 width is not printed. The number of characters that can be printed on one line depends on the printer.
- Up to 160 characters can be printed in a single line. Any text exceeding 160 characters is cut off.
- Regardless of the Show Column settings, the column portion will not be printed.
- When printing only the displayed portion, if the data in the right most cell extends beyond the screen and is cut off on the Show CSV Display, that portion is also cut off on the printout.
- While printing, you cannot edit data or execute other print jobs. Also, the system cannot be switched to off-line mode.

24.13.3 Restrictions on Transferring Filing Data

- Up to 8,999 folders can be registered. However, only one folder can be stored in backup SRAM.
- The size of one folder can be up to the same size as the total capacity of the backup SRAM when only recipes are stored.
Even when filing data is stored on a CF Card/USB storage device, regardless of the CF Card/USB storage memory capacity, one folder must have a capacity equal to the backup SRAM's maximum capacity.
- Up to 2,048 files can be set in one folder.
- Up to 1,650 blocks can be saved in one file. (The maximum number changes depending on the Number of Files and Number of Data Items.)
- The maximum amount of data in one block is 10,000 for 16-bit data, or 5,000 for 32-bit data. The maximum limit depends on the number of files and number of blocks.
- The more data transferred to the device/PLC, the more time it takes to complete the write operation. The time from when transfer starts to when transfer is complete can vary from several seconds to several minutes.
- While writing to a device/PLC, the display of Parts may not update properly or may become slow. Screen changes and other operations may also slow down.
- If a screen change occurs during transfer, in order to read the screen information, it may take some time to write to the device/PLC.
- Wait until a transfer completes before initiating another one. If a transfer is started before the previous one ends, such as when an automatic transfer and manual transfer occur at the same time, the second transfer operation may not be accepted.
- Data in backup SRAM is erased when:
 - Screen transfer occurs
 - Memory is reset (Offline)
 - Backup SRAM is initialized (Offline)
- When placing multiple Special Data Displays [Filing] on one screen, do not use the same [ID Number] for multiple Displays.
- You cannot move the generated Recipe data to a different project for editing.
- Recipe data generated in the CF Card or USB Storage Designation Folder cannot be used in other projects.