

13 | Using Lamps

This chapter explains how to display and operate the "Lamp" in GP-Pro EX. Please start by reading "13.1 Settings Menu" (page 13-2) and then turn to the corresponding page.

13.1	Settings Menu	13-2
13.2	Turning the Lamp ON/OFF with the ON/OFF Bit	13-4
13.3	Switching by Turning Multiple Bits ON/OFF (Up to 5 States)	13-8
13.4	Switching by a Combination of Multiple Bits (Up to 16 States)	13-13
13.5	Switching by the Word Address Bit Change (Bit Settings)	13-19
13.6	Change When Word Address Value Changes	13-25
13.7	Procedure for Creating a Lamp.....	13-31
13.8	Lamp Settings Guide.....	13-33

13.1 Settings Menu

Turning the Lamp ON/OFF with the ON/OFF Bit

Turned ON with the specified bit address ON

X100: ON → Turned ON



Turned OFF with the specified bit address OFF

X100: OFF → Turned OFF

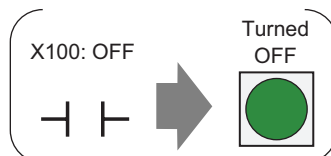

☞ Setup Procedure (page 13-5)

☞ Introduction (page 13-4)

Switching by Turning Multiple Bits ON/OFF (Up to 5 States)

Use a single lamp on the GP to display in different colors the ON/OFF states of four different bit addresses.

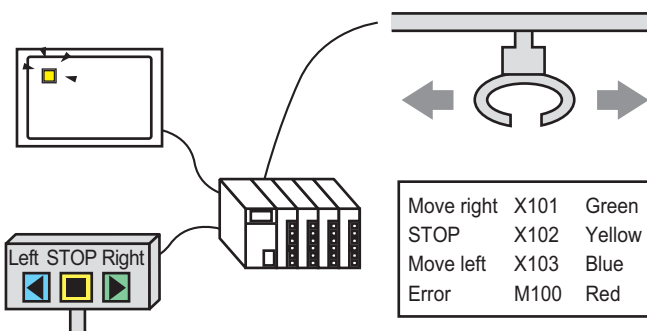

Move right	X101	Green
STOP	X102	Yellow
Move left	X103	Blue
Error	M100	Red

☞ Setup Procedure (page 13-9)

☞ Introduction (page 13-8)

Switching by a Combination of Multiple Bits (Up to 16 States)

Use a single lamp on the GP to display in different colors the ON/OFF states for a combination of up to four bit addresses.

Display with different colors depending on bit combinations

State	Display Color	X104	X103	X102	X101
State 00	Blue	0	0	0	0
State 01	Red	0	0	0	1
State 02	Yellow	0	0	1	0
State 03	Green	0	0	1	1
⋮	⋮	⋮	⋮	⋮	⋮

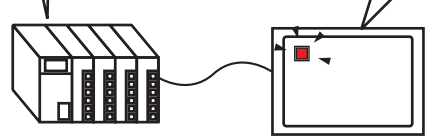

☞ Setup Procedure (page 13-14)

☞ Introduction (page 13-13)

GP-Pro EX Reference Manual

13-2

Switching by the Word Address Bit Change (Bit Settings)

Use a single lamp on the GP to display in different colors the ON/OFF state of each of the 16 bits in a PLC word address.

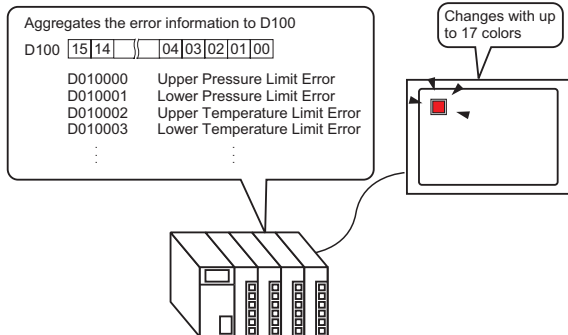

- ☞ Setup Procedure (page 13-20)
- ☞ Introduction (page 13-19)

Change When Word Address Value Changes

Use a single lamp on the GP to display in different colors, the value (0 to 255) stored in a PLC word address.

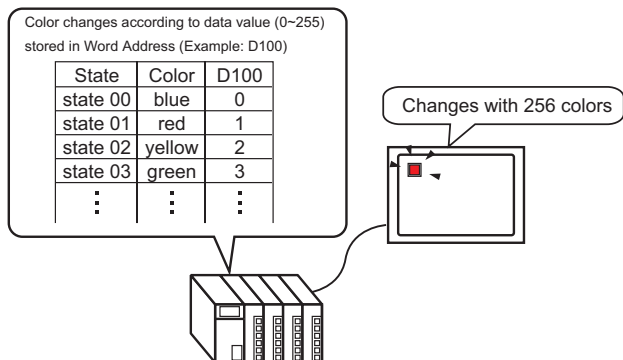

- ☞ Setup Procedure (page 13-26)
- ☞ Introduction (page 13-25)

13.2 Turning the Lamp ON/OFF with the ON/OFF Bit

13.2.1 Introduction

Displays on the GP the ON/OFF state of the device/PLC bit address.

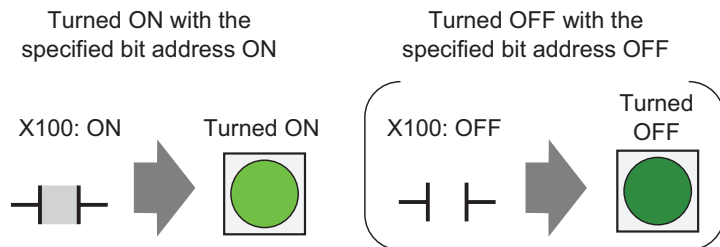

IMPORTANT

- If the state display is set to [Interlock Feature] or [Delay Feature], then [Interlock Condition Display] has the highest priority followed by [In-Delay Status Display]. Consequently, the lamp may not display as expected. You can access this option from the [Switch/Lamp] dialog box, select the [Switch Common] tab and then select [Detail].
-

13.2.2 Setup Procedure

NOTE

- Please refer to the settings guide for details.
 - ☞ "13.8 Lamp Settings Guide" (page 13-33)
- For details of the part placement method and the address, shape, color, and label setting method, refer to the "Part Editing Procedure".
 - ☞ "8.6.1 Editing Parts" (page 8-52)

Displays on the GP the ON/OFF state of the bit address (X100).

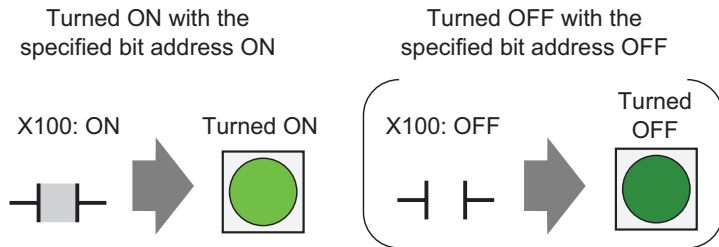

- 1 From the [Part (P)] menu, point to [Switch Lamp (C)] and select [Lamp (L)] or click  from the toolbar. Place the Part on the screen.
- 2 Double-click the placed lamp. The Switch/Lamp dialog box appears.

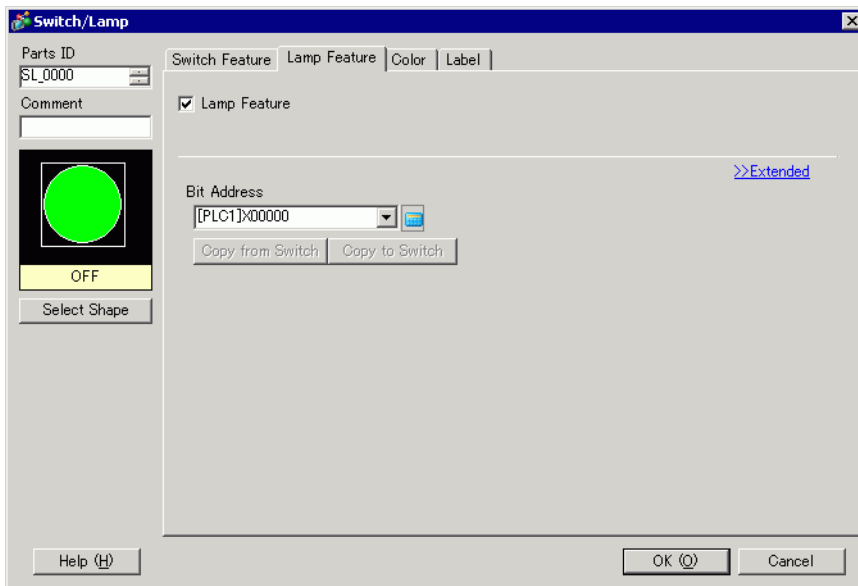

3 In [Select Shape], choose the lamp shape. Click [OK].

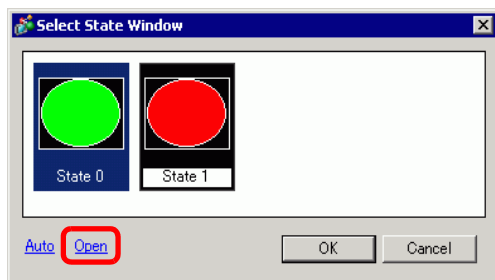

4 Set the bit address to turn ON/OFF the lamp. (For example, X100)

Click the icon to display an address input keypad.

Select the device "X", input "100" in the address, and press the "Ent" key.

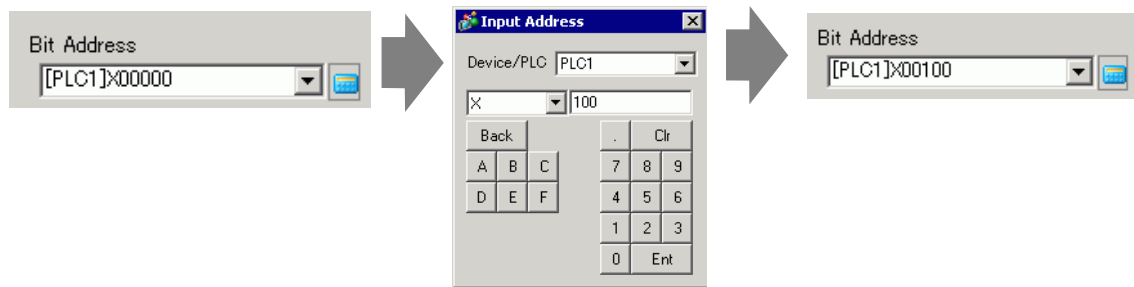

5 Click the [Color] tab. In [Select State], choose ON or OFF, then set the [Display Color], [Pattern], and [Border Color] for each state.

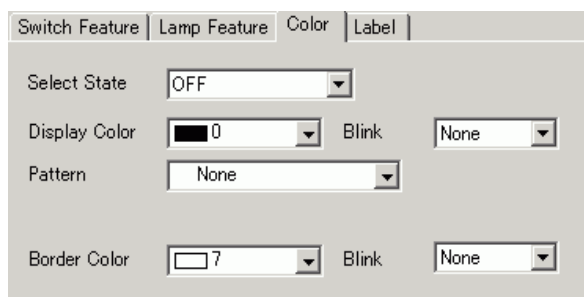

- 6 Click the [Label] tab. Select either [Direct Text] or [Text Table], then specify the font type and size for each selected state. Type the text to display then click [OK].

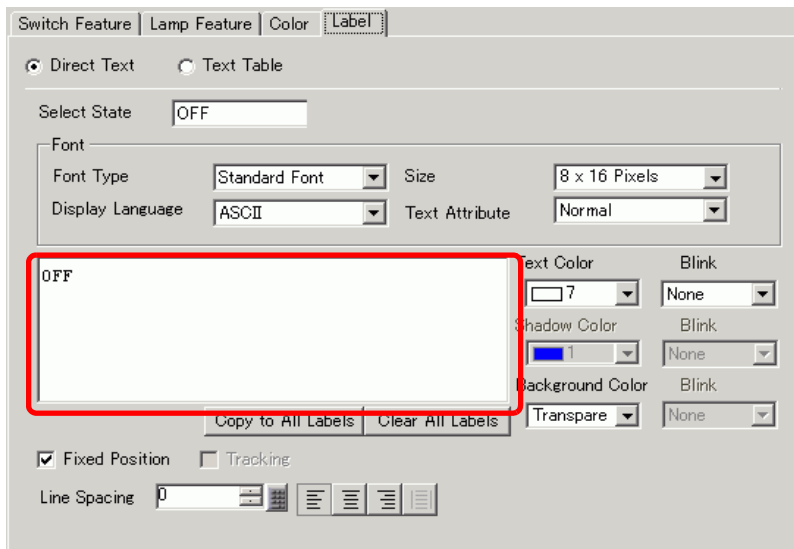

The process is complete.

13.3 Switching by Turning Multiple Bits ON/OFF (Up to 5 States)

13.3.1 Introduction

Use a single lamp on the GP to display in different colors the ON/OFF states of four different bit addresses.

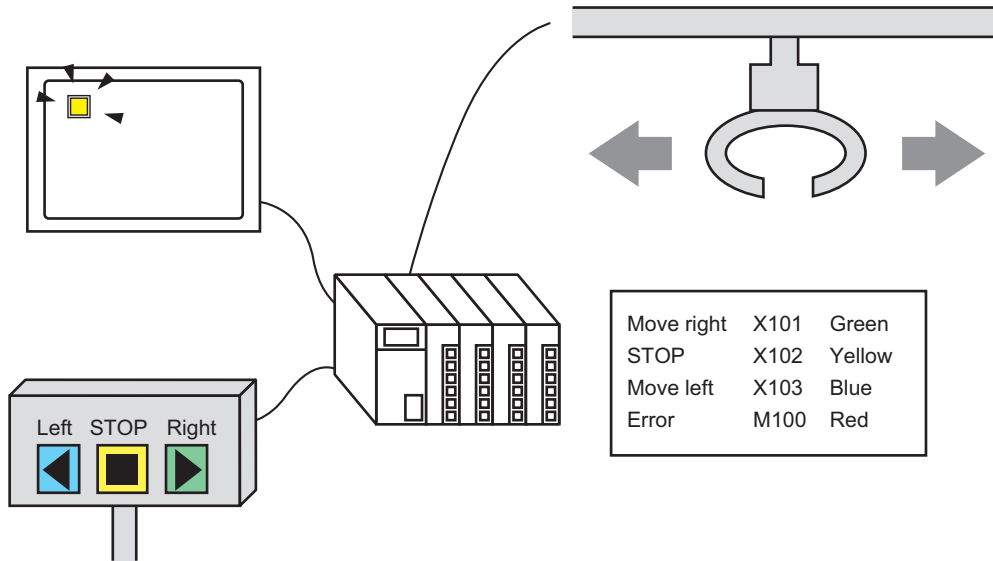

IMPORTANT

- If the state display is set to [Interlock Feature] or [Delay Feature], then [Interlock Condition Display] has the highest priority followed by [In-Delay Status Display]. Consequently, the lamp may not display as expected. You can access this option from the [Switch/Lamp] dialog box, select the [Switch Common] tab and then select [Detail].
- The four bit addresses specified in a lamp can be bit addresses from different devices/PLCs.

13.3.2 Setup Procedure

NOTE

- Please refer to the Settings Guide for details.
 - ☞ "13.8 Lamp Settings Guide" (page 13-33)
- For details of the part placement method and the address, shape, color, and label setting method, refer to the "Part Editing Procedure".
 - ☞ "8.6.1 Editing Parts" (page 8-52)

The following procedure uses a total of four bits in a lamp to display different colors for crane movement (right, left and stop), the error notification bit, and the all OFF state.

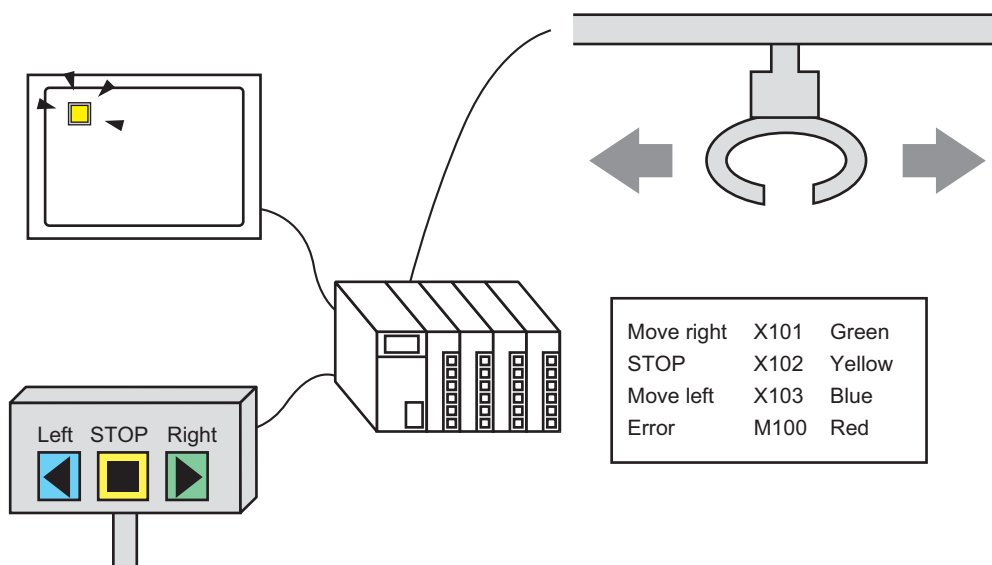

Switching by Turning Multiple Bits ON/OFF (Up to 5 States)

- 1 From the [Part (P)] menu, point to [Switch Lamp (C)] and select [Lamp (L)] or click  from the toolbar. Place the Part on the screen.
- 2 Double-click the placed lamp. The Switch/Lamp dialog box appears.

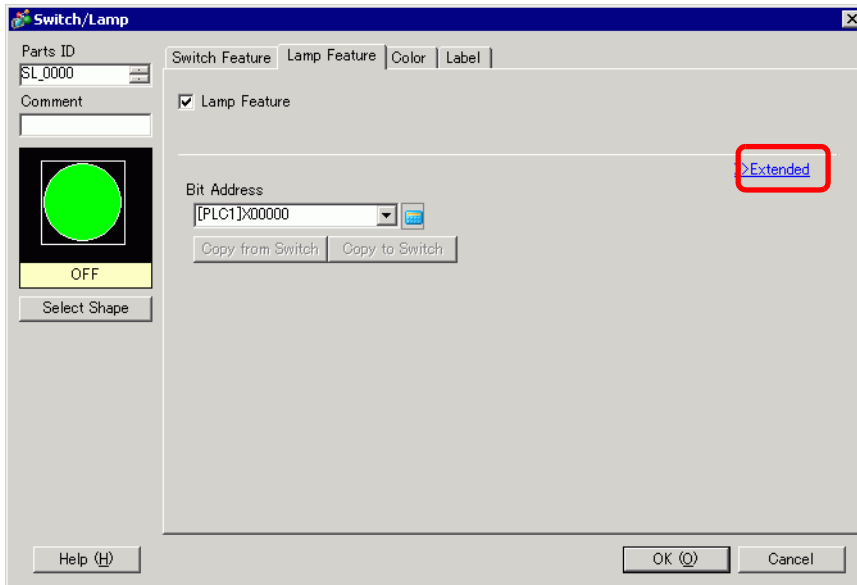

- 3 Set the [Number of States] and [State Switch Condition]. Setting the [Number of States] to 3 or more allows you to set [State Switch Condition]. (For example, [Number of States] 5, [State Switch Condition] Change Condition by Bit)

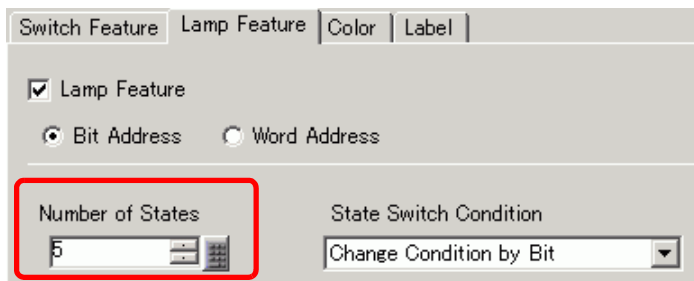

- 4 Set [Bit Address 1]. In the [Input Address] dialog box, select the device/PLC and set X101 to the device address, and click [Ent]. (For example, X101).

Click the icon to display an address input keypad.

Select the device "X", input "101" in the address, and press the "Ent" key.

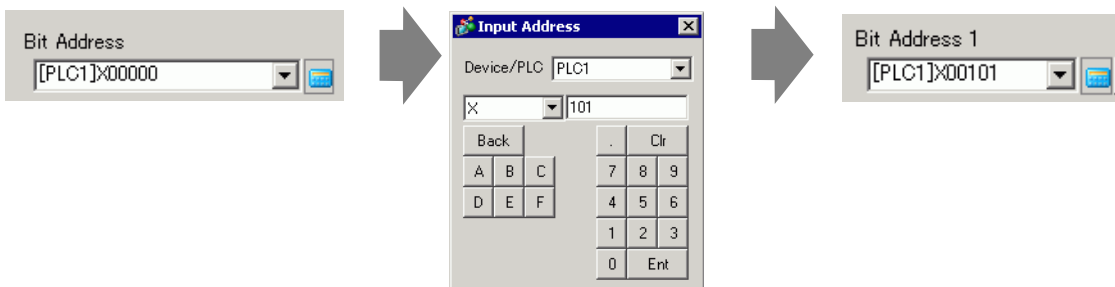

- 5 Also, set [Bit Address 2] to [Bit Address 4] as follows.
 (For example [Bit Address 2] X102, [Bit Address 3] X103, [Bit Address 4] M100)

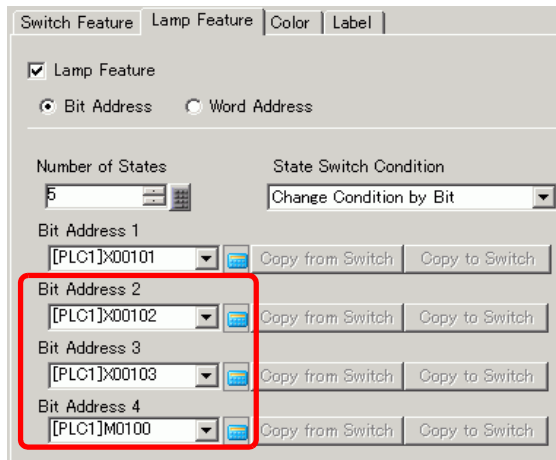

IMPORTANT

- Each [State] is defined as the ON (1)/OFF (0) of the corresponding bit address.

State	Description			
	Bit Address 4	Bit Address 3	Bit Address 2	Bit Address 1
[State 0]	0	0	0	0
[State 1]	0	0	0	1
[State 2]	0	0	1	0
[State 3]	0	1	0	0
[State 4]	1	0	0	0

- When multiple bits turn ON at the same time, the lamp displays the states in order, from [Bit Address 1], [Bit Address 2], [Bit Address 3] to [Bit Address 4],

- 6 In [Select Shape], select the lamp shape for each [State].
 7 Click the [Color] tab. Select [State0] in [Select State] and set [Display Color] to set the Lamp display color for each of the five states. [State 0] is the state where the specified bit addresses are "All OFF".

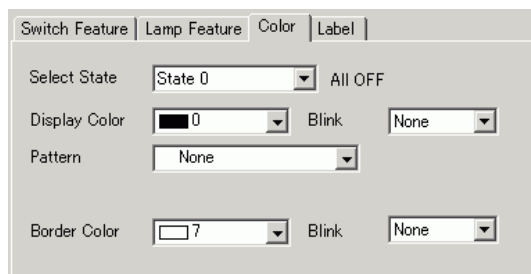

8 Bit Address X101 is ON. [State 1] is the state where the specified Bit Address X101 is ON.

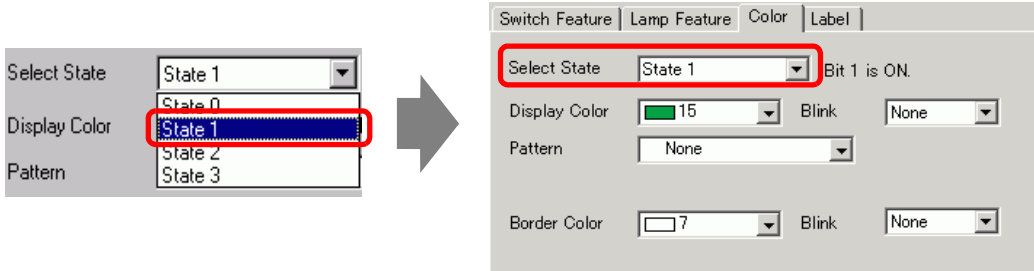

9 Set [Display Color] for [State 2] to [State 4].

10 Click the [Label] tab. Select either [Direct Text] or [Text Table], then specify the font type and size for each selected state. Type the text to display then click [OK].

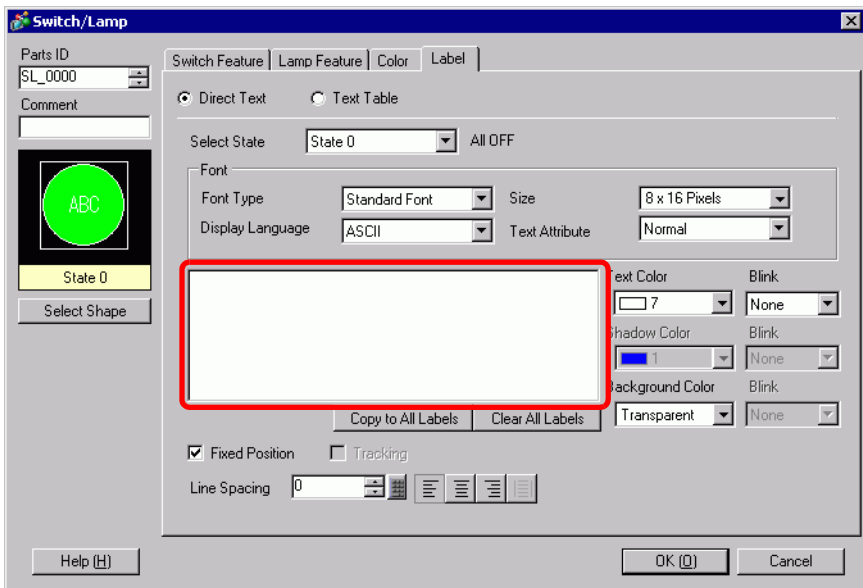

The process is complete.

13.4 Switching by a Combination of Multiple Bits (Up to 16 States)

13.4.1 Introduction

A single lamp can display in different colors the combined ON/OFF states of up to 4 bit addresses from a connected device/PLC, resulting in 16 states.

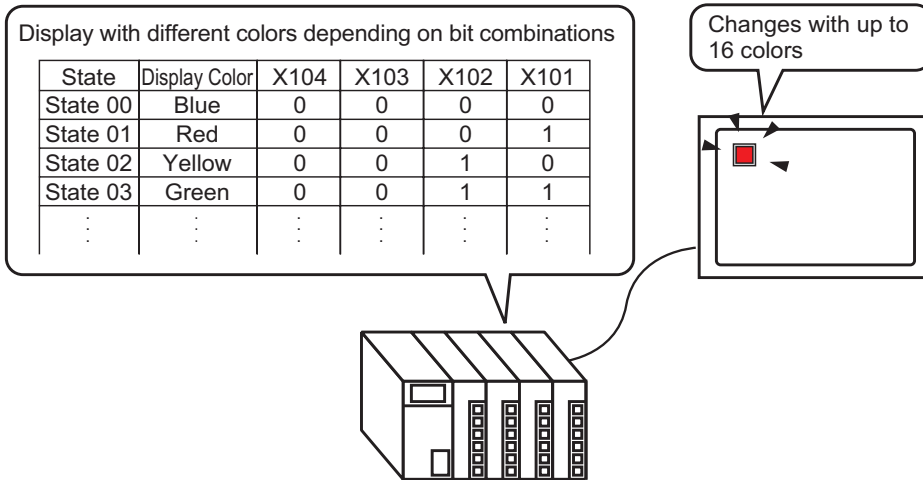
IMPORTANT

- If the state display is set to [Interlock Feature] or [Delay Feature], then [Interlock Condition Display] has the highest priority followed by [In-Delay Status Display]. Consequently, the lamp may not display as expected. You can access this option from the [Switch/Lamp] dialog box, select the [Switch Common] tab and then select [Detail].
- The four bit addresses specified to one lamp can be the bit addresses in different devices/PLCs.

13.4.2 Setup Procedure

NOTE

- Please refer to the settings guide for details.
 - ☞ "13.8 Lamp Settings Guide" (page 13-33)
- For details of the part placement method and the address, shape, color, and label setting method, refer to the "Part Editing Procedure".
 - ☞ "8.6.1 Editing Parts" (page 8-52)

The following procedure combines four bits (X101 to X104) in a lamp to display different colors for 16 states.

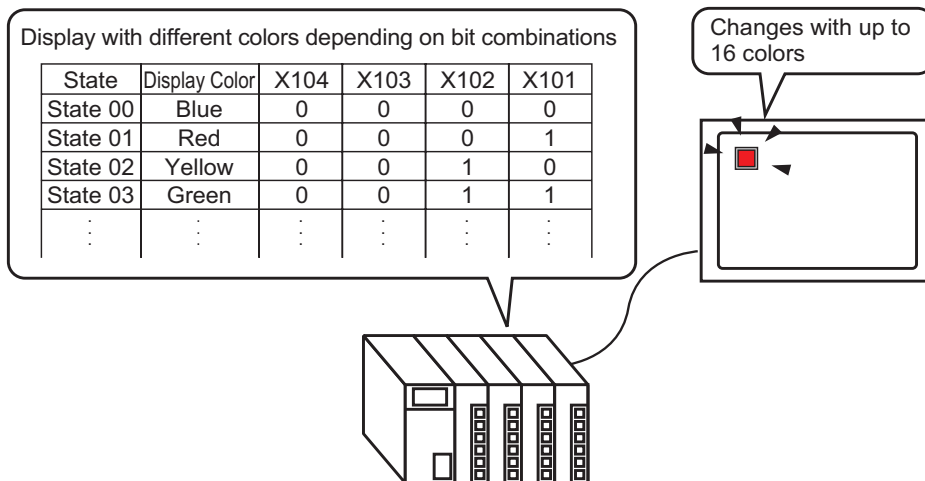

Switching by a Combination of Multiple Bits (Up to 16 States)

- 1 From the [Part (P)] menu, point to [Switch Lamp (C)] and select [Lamp (L)] or click  from the toolbar. Place the Part on the screen.
- 2 Double-click the placed lamp. The Switch/Lamp dialog box appears.

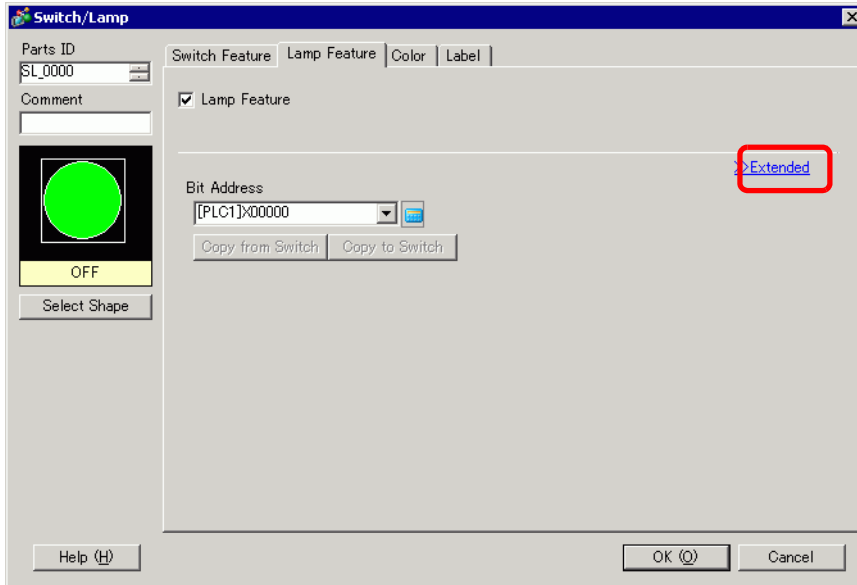

- 3 Set the [Number of States] and [State Switch Condition]. Setting the [Number of States] to 3 or more allows you to set [State Switch Condition]. (For example, [Number of States] 16, [State Switch Condition] Change Condition by Bit Combination)

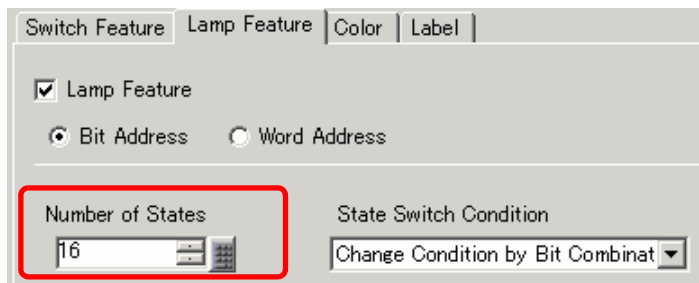

4 Specify the address to display the color coding of the lamp in [Bit Address]. (For example, X101)

Click the icon to display an address input keypad.

Select the device "X", input "101" in the address, and press the "Ent" key.

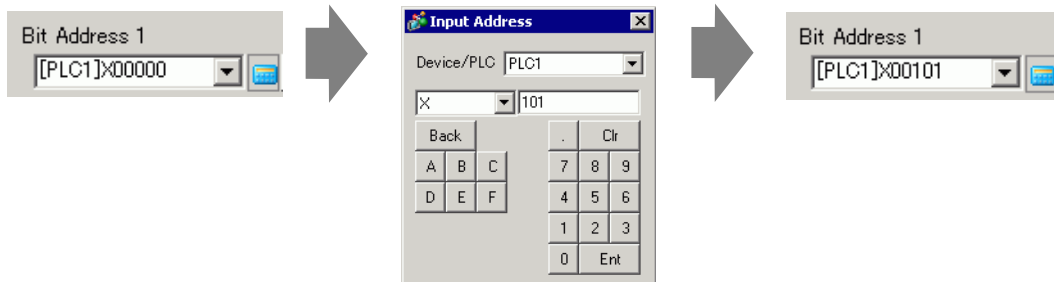

IMPORTANT

- Each [State] is defined as the ON (1)/OFF (0) of the corresponding bit address.

State	Description			
	Bit Address 4	Bit Address 3	Bit Address 2	Bit Address 1
[State 0]	0	0	0	0
[State 1]	0	0	0	1
[State 2]	0	0	1	0
[State 3]	0	0	1	1
[State 4]	0	1	0	0
[State 5]	0	1	0	1
[State 6]	0	1	1	0
[State 7]	0	1	1	1
[State 8]	1	0	0	0
[State 9]	1	0	0	1
[State 10]	1	0	1	0
[State 11]	1	0	1	1
[State 12]	1	1	0	0
[State 13]	1	1	0	1
[State 14]	1	1	1	0
[State 15]	1	1	1	1

- 5 Also, set [Bit Address 2] to [Bit Address 4] as follows.
 (For example [Bit Address 2] X102, [Bit Address 3] X103, [Bit Address 4] X104)

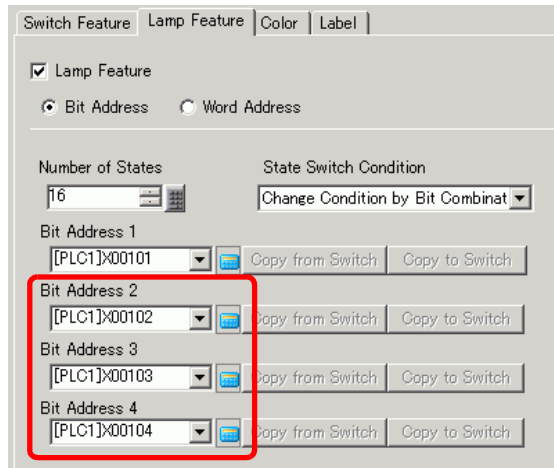

- 6 In [Select Shape], select the lamp shape for each [State].
 7 Click the [Color] tab. Select [State0] in [Select State] and set [Display Color] to set the Lamp display color for each of the 16 states.
 [State 0] is the state where the specified bit addresses are "All OFF".

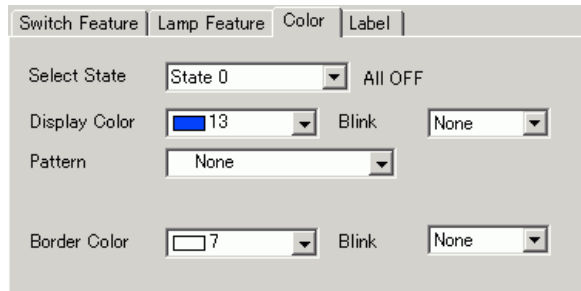

- 8 In the [Select State] list, select [State 1] and define its [Display Color]. [State 1] is the state when the specified bit address (X101) is ON.

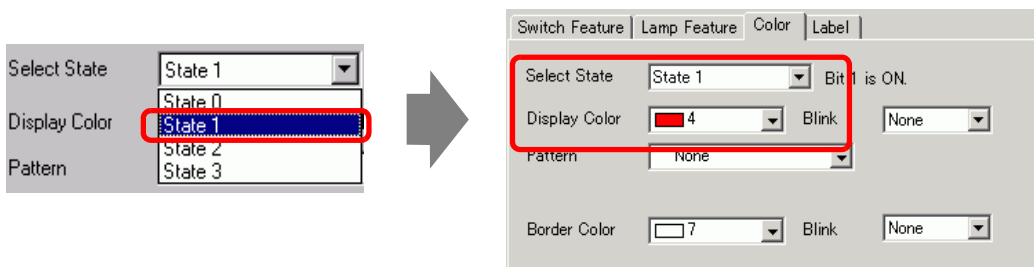

- 9 Set the display colors for [State 2] to [State 15].

- 10 Click the [Label] tab. Select either [Direct Text] or [Text Table], then specify the font type and size for each selected state. Type the text to display then click [OK].

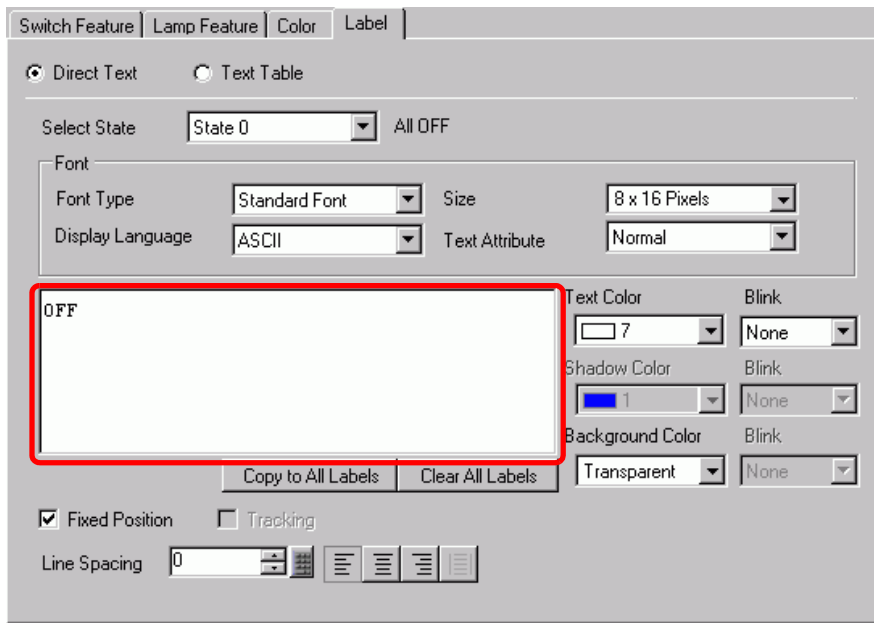

The process is complete.

13.5 Switching by the Word Address Bit Change (Bit Settings)

13.5.1 Introduction

Use a single lamp on the GP to display in different colors the ON/OFF state of each of the 16 bits in a PLC word address.

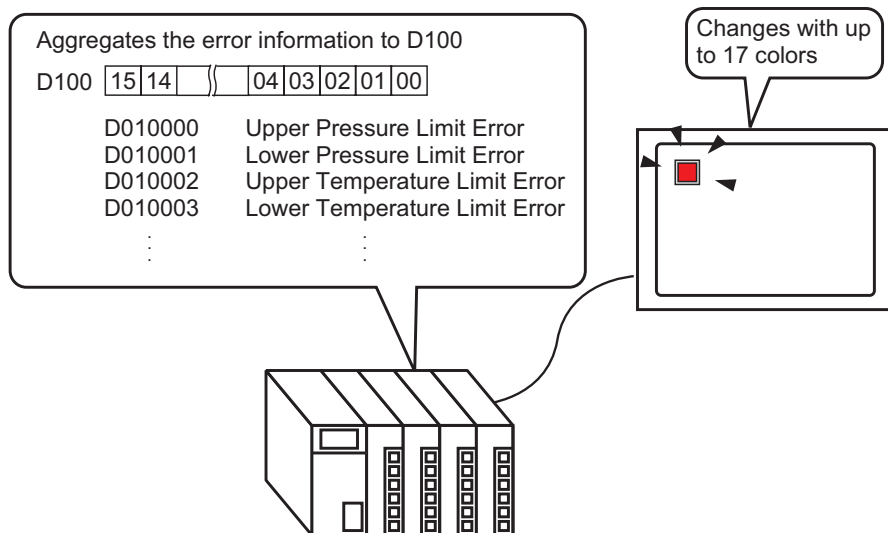
IMPORTANT

- If the state display is set to [Interlock Feature] or [Delay Feature], then [Interlock Condition Display] has the highest priority followed by [In-Delay Status Display]. Consequently, the lamp may not display as expected. You can access this option from the [Switch/Lamp] dialog box, select the [Switch Common] tab and then select [Detail].

13.5.2 Setup Procedure

NOTE

- Please refer to the settings guide for details.
 ☞ "13.8 Lamp Settings Guide" (page 13-33)
- For details of the part placement method and the address, shape, color, and label setting method, refer to the "Part Editing Procedure".
 ☞ "8.6.1 Editing Parts" (page 8-52)

In the following procedure, error information from a device/PLC is mapped to each bit in a word address (D100). When an error occurs, the corresponding word address bit turns ON and a lamp set up with that same word address displays its associated color.

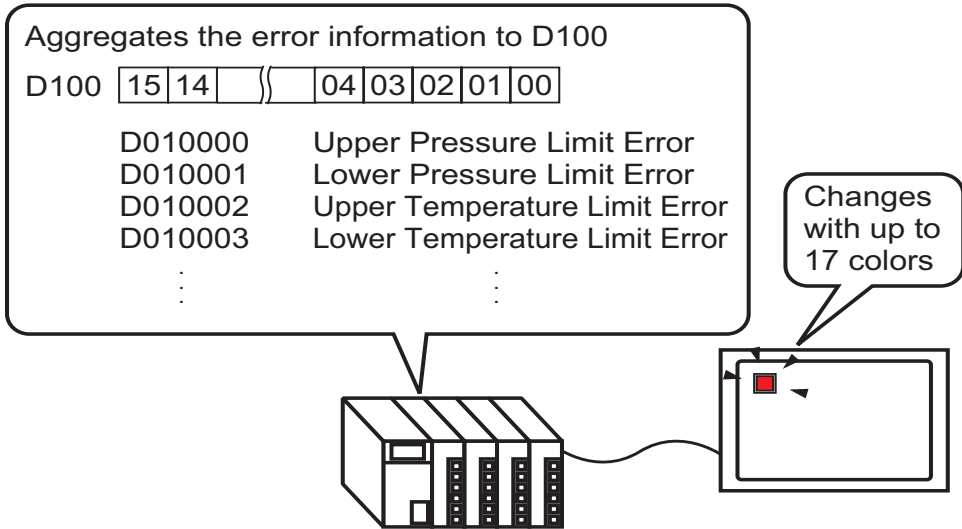

Switching by the Word Address Bit Change (Bit Settings)

- 1 From the [Part (P)] menu, point to [Switch Lamp (C)] and select [Lamp (L)] or click  from the toolbar. Place the Part on the screen.
- 2 Double-click the placed lamp. The Switch/Lamp dialog box appears.

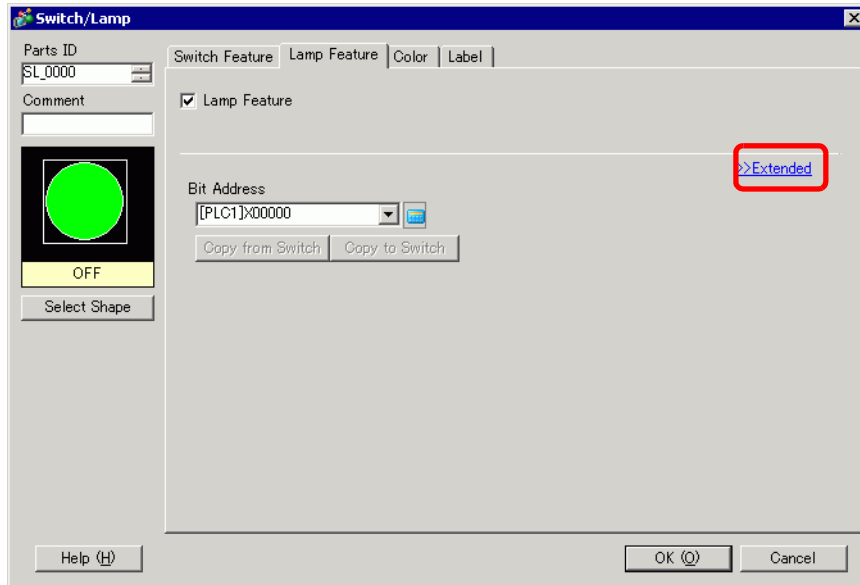

- 3 Select the [Word Address]. Set the [Number of States] and [State Switch Condition]. Setting the [Number of States] to 3 or more allows you to set [State Switch Condition]. (For example, [Number of States] 17, [State Switch Condition] Change Condition by Bit)

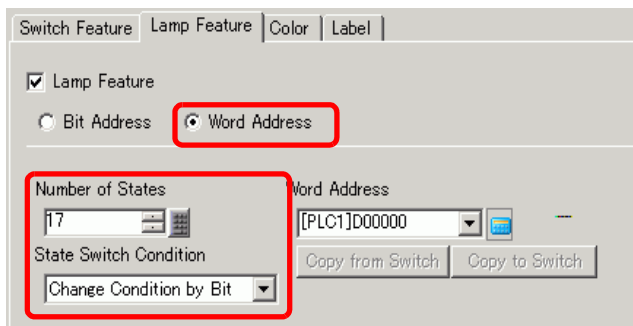

- 4 Specify the address to display the color coding of the lamp in [Word Address]. (For example, D100)

Click the icon to display an address input keypad.

Select device "D", input "100" as the address, and press the "Ent" key.

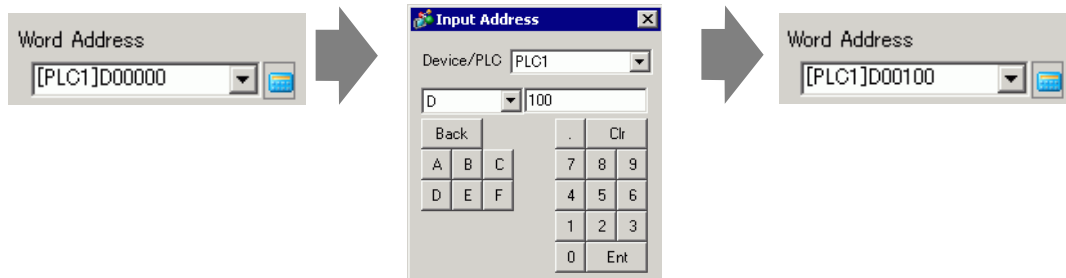

- 5 In [Select Shape], select the lamp shape for each [State].
- 6 Click the [Color] tab. Select [State 0] in [Select State] and set [Display Color] to set the Lamp display color for each of the 17 states. [State 0] is the state where the specified bit addresses are "All OFF".

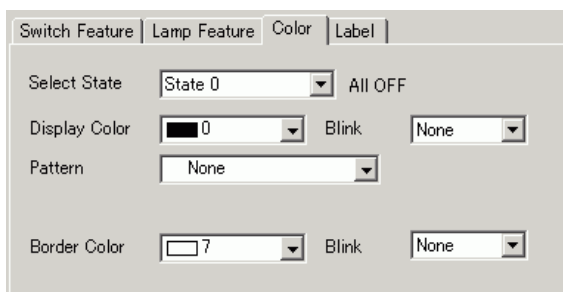

IMPORTANT

- Each [State] is defined as the ON (1)/OFF (0) of the corresponding bit address.

State	Description
[State 0]	All 0
[State 1]	Only Bit 00 is 1.
[State 2]	Only Bit 01 is 1.
[State 3]	Only Bit 02 is 1.
[State 4]	Only Bit 03 is 1.
[State 5]	Only Bit 04 is 1.
[State 6]	Only Bit 05 is 1.
[State 7]	Only Bit 06 is 1.
[State 8]	Only Bit 07 is 1.
[State 9]	Only Bit 08 is 1.
[State 10]	Only Bit 09 is 1.
[State 11]	Only Bit 10 is 1.
[State 12]	Only Bit 11 is 1.
[State 13]	Only Bit 12 is 1.
[State 14]	Only Bit 13 is 1.
[State 15]	Only Bit 14 is 1.
[State 16]	Only Bit 15 is 1.

- When multiple bits turn ON at the same time, a lamp display appears in the ascending order from [Bit 0] to [Bit 15], giving priority to the smallest number.

7 In [Select State], select [State 1] and set the [Display Color]. [State 1] is the state where Bit 0 of Word Address D100 is ON.

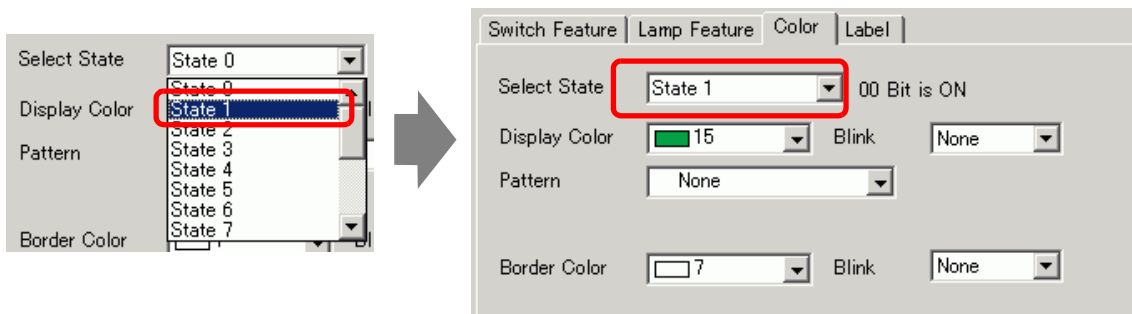

8 Set [Display Color] for states, from [State 2] to [State 16].

- 9 Click the [Label] tab. Select either [Direct Text] or [Text Table], then specify the font type and size for each selected state. Type the text to display then click [OK].

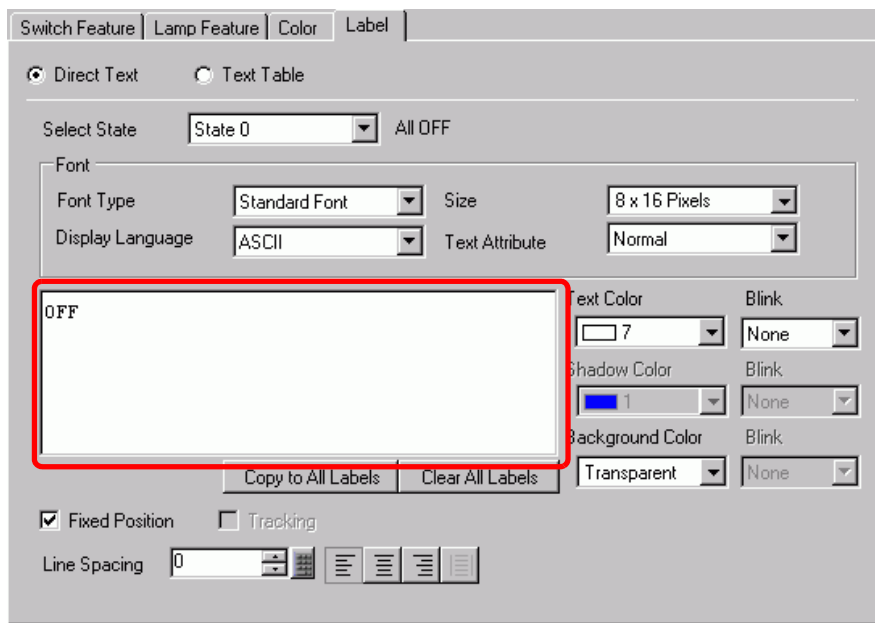

The process is complete.

13.6 Change When Word Address Value Changes

13.6.1 Introduction

Monitors the word address value to display different colors for up to 256 states in a single lamp.

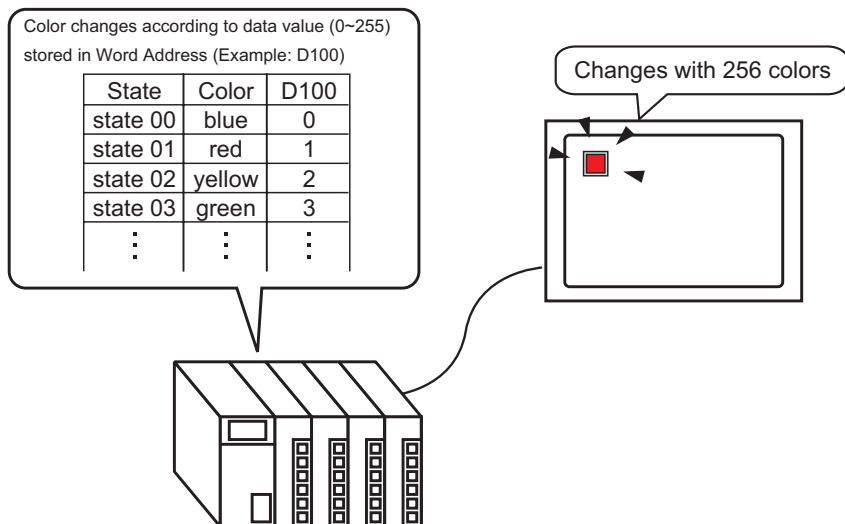
IMPORTANT

- If the state display is set to [Interlock Feature] or [Delay Feature], then [Interlock Condition Display] has the highest priority followed by [In-Delay Status Display]. Consequently, the lamp may not display as expected. You can access this option from the [Switch/Lamp] dialog box, select the [Switch Common] tab and then select [Detail].

13.6.2 Setup Procedure

NOTE

- Please refer to the settings guide for details.
 - ☞ "13.8 Lamp Settings Guide" (page 13-33)
- For details of the part placement method and the address, shape, color, and label setting method, refer to the "Part Editing Procedure".
 - ☞ "8.6.1 Editing Parts" (page 8-52)

When the value in the associated word address changes, the display state of the lamp also changes.

In the following procedure, the combination of bits 00 to 07 in word address D100 can be used to display in a single lamp different colors for up to (256 states).

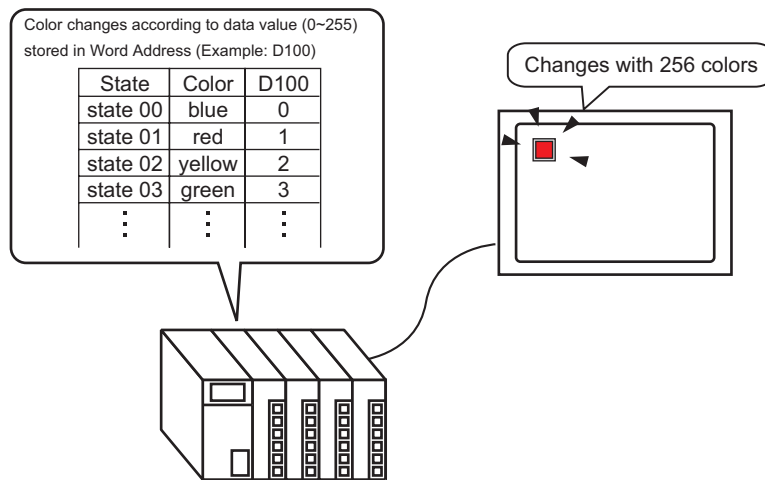

- 1 From the [Part (P)] menu, point to [Switch Lamp (C)] and select [Lamp (L)] or click  from the toolbar. Place the Part on the screen.
- 2 Double-click the placed lamp. The Switch/Lamp dialog box appears.

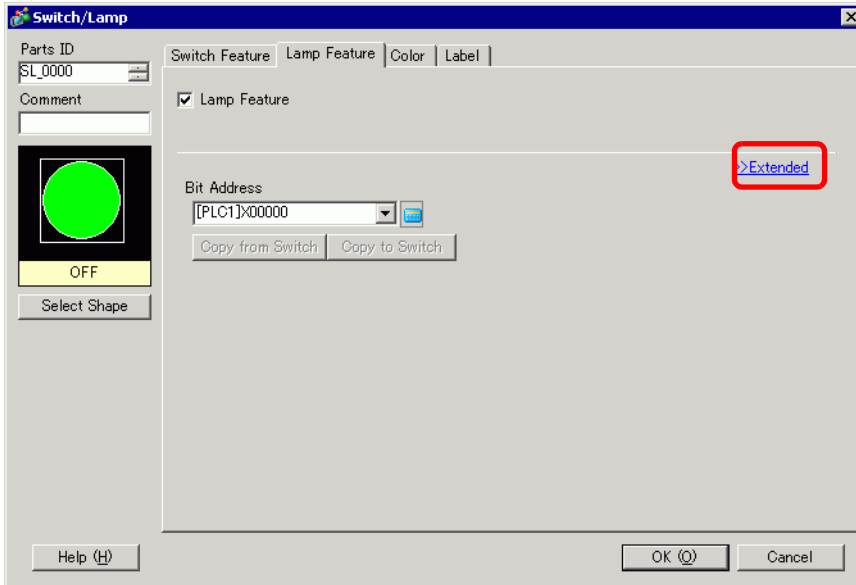

- 3 Select the [Word Address]. Set the [Number of States] and [State Switch Condition]. Setting the [Number of States] to 3 or more allows you to set [State Switch Condition].
(Example: [Number of States] = 256, [State Switch Condition] = Change Condition by Data)

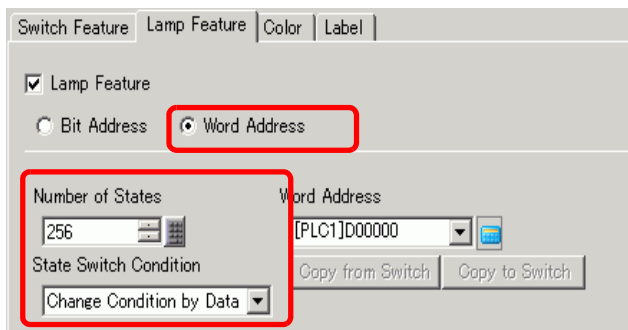

4 Specify the address to display the color coding of the lamp in [Word Address]. (For example, D100)

Click the icon to display an address input keypad.

Select device "D", input "100" as the address, and press the "Ent" key.

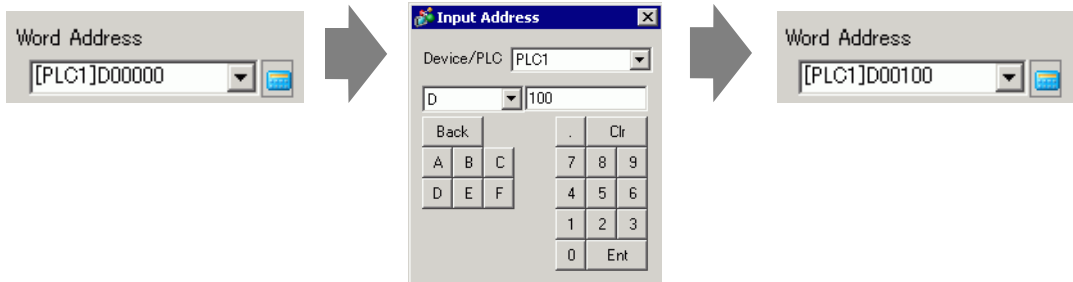

5 In [Select Shape], select the lamp shape for each [State].

6 Click the [Color] tab. In the [Select State] list, select [State 0] and define its [Display Color]. [State 0] is the state in which all the bits are All OFF.

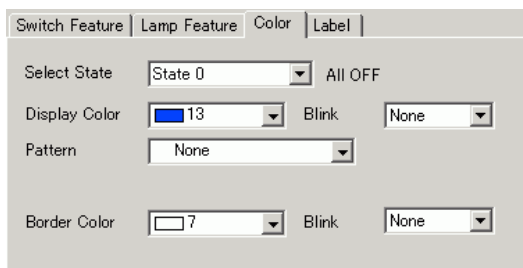

IMPORTANT

- The [State] is defined by the bottom 8 bits (00 to 07) in the specified word address.

State	Description							
	07 bit	06 bit	05 bit	04 bit	Bit 03	Bit 02	Bit 01	Bit 00
[State 0]	0	0	0	0	0	0	0	0
[State 1]	0	0	0	0	0	0	0	1
[State 2]	0	0	0	0	0	0	1	0
[State 3]	0	0	0	0	0	0	1	1
[State 4]	0	0	0	0	0	1	0	0
[State 5]	0	0	0	0	0	1	0	1
[State 6]	0	0	0	0	0	1	1	0
[State 7]	0	0	0	0	0	1	1	1
[State 8]	0	0	0	0	1	0	0	0
[State 9]	0	0	0	0	1	0	0	1
[State 10]	0	0	0	0	1	0	1	0
[State 11]	0	0	0	0	1	0	1	1
[State 12]	0	0	0	0	1	1	0	0
[State 13]	0	0	0	0	1	1	0	1
[State 14]	0	0	0	0	1	1	1	0
[State 15]	0	0	0	0	1	1	1	1
[State 16]	0	0	0	1	0	0	0	0
[State 17]	0	0	0	1	0	0	0	1
⋮	⋮	⋮	⋮	⋮	⋮	⋮	⋮	⋮
[State 255]	1	1	1	1	1	1	1	1

7 Select [State 1] in [Select State] and set the [Display Color]. [State 1] is the state where the specified Word address D100 stores 1.

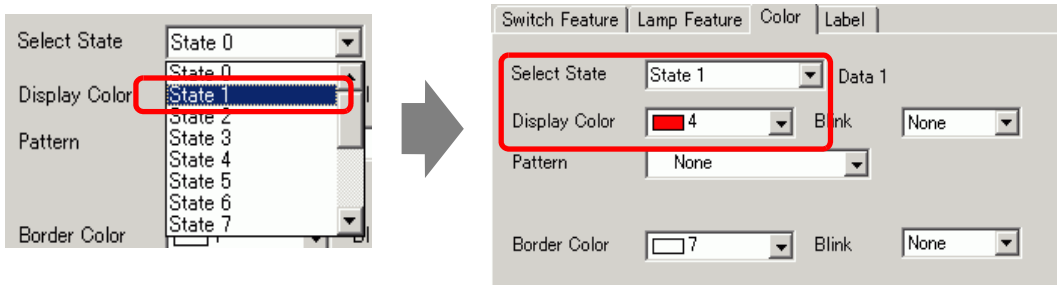

8 Similarly, in the [Select State] list, select [State 2] to [State 255] and define its [Display Color].

- 9 Click the [Label] tab. Select either [Direct Text] or [Text Table], then specify the font type and size for each selected state. Type the text to display then click [OK].

Switch Feature | Lamp Feature | Color | Label

Direct Text Text Table

Select State: State 0 Data 0

Font

Font Type: Standard Font Size: 8 x 16 Pixels

Display Language: ASCII Text Attribute: Normal

OFF

Text Color: 7 Blink: None

Shadow Color: 1 Blink: None

Background Color: Transparent Blink: None

Fixed Position Tracking

Line Spacing: 0

Copy to All Labels Clear All Labels

The process is complete.

13.7 Procedure for Creating a Lamp

From the [Part (P)] menu, point to [Switch Lamp (C)] and select [Lamp (L)] or click  from the toolbar. Place the Part on the screen.

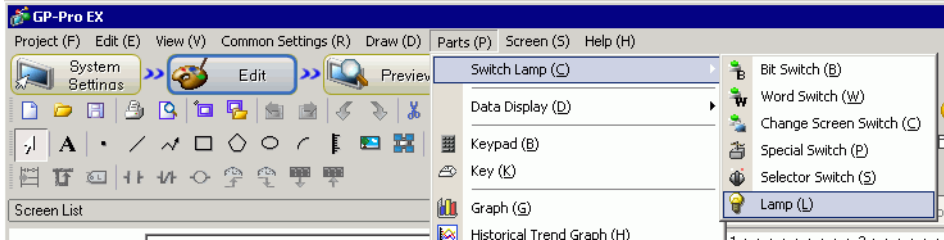

Double-click the placed lamp. The Switch/Lamp dialog box appears.

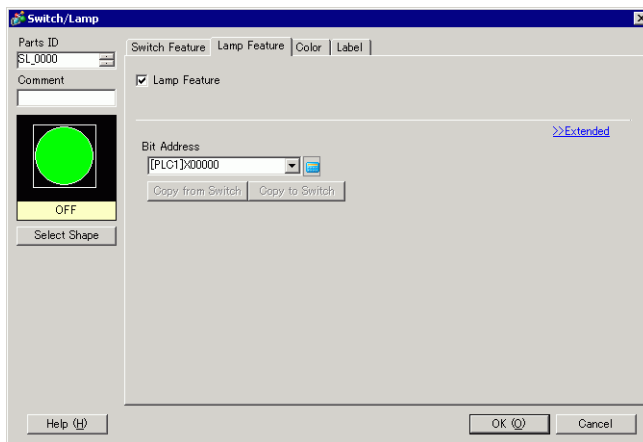

Use [Select Shape] to define the frame of the lamp. When using multiple bit and word addresses, use [Select Shape] after defining the number of states and define the lamp frame for each state.

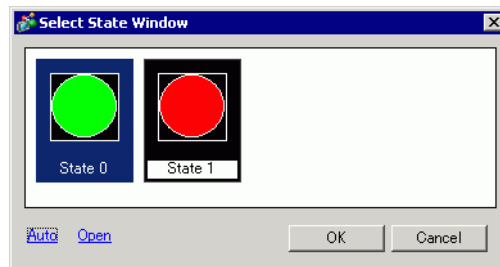

- If you set up the lamp after the shape is already selected in a switch, the same shape is applied to [State 0] and [State 1].



Procedure for Creating a Lamp

To display the ON/OFF state of a bit address with the lamp, specify the bit address in the [Basic] dialog box.

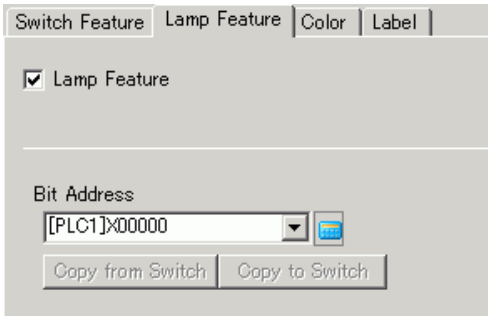

When using multiple bit addresses or Word addresses, click [Details]. Specify the operation condition and bit addresses for the lamp.

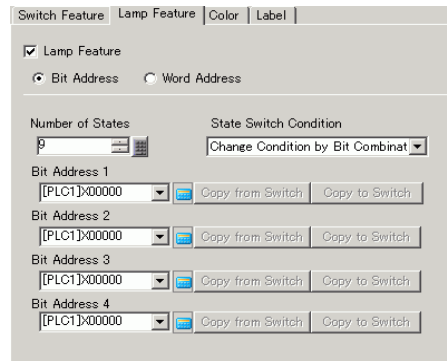

Click the [Color] tab and set the Lamp display colors.

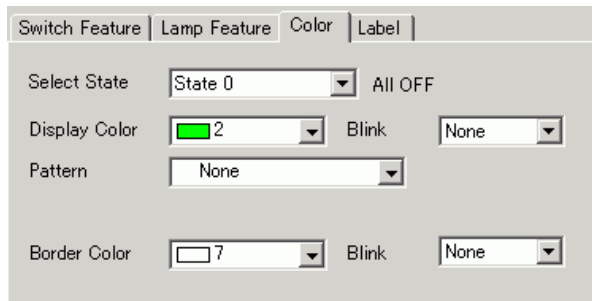

Click the [Label] tab to set up text displayed on the lamp. When you select Direct Text, specify the font type, font size, and display text.

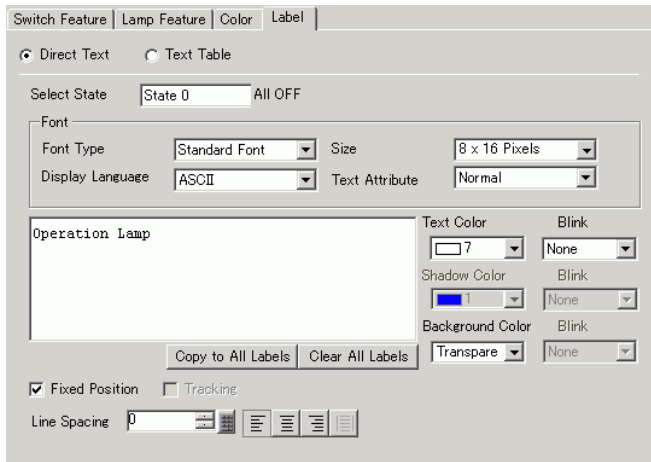

Click [OK] to confirm the settings.

13.8 Lamp Settings Guide

13.8.1 Common to All Parts

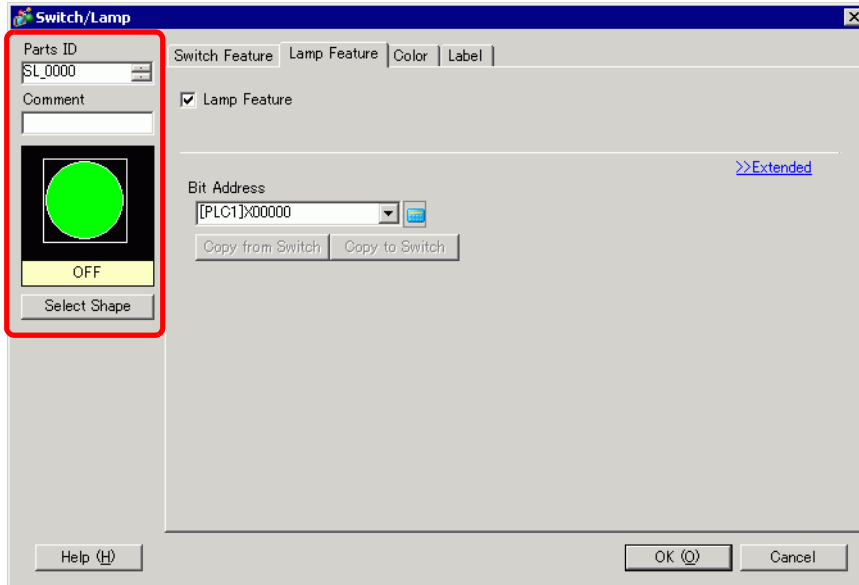

Setting	Description
Part ID	Placed parts are automatically assigned an ID number. Switch lamp part ID : SL_ (4 digits) The letter portion of the ID is fixed and depends on the part. The number portion can be changed. The setting range is from 0000 to 9999.
Comment	The comment for each Part can be up to 20 characters long.

Continued

Setting	Description
<p>Select Shape</p>	<p>The part shapes can be changed.</p> <div data-bbox="583 227 1085 494" data-label="Image"> </div> <p>Double-click a part in each state in the [Select State Window], or click [Open] to display the [Shape Browser].</p> <div data-bbox="546 595 1094 788" data-label="Image"> </div> <p>Clicking <input type="button" value="v"/> to the right of the [Parts Palette] or [Browse] displays the Parts Palette. There are 65535, 256, or 64 color parts. Select the parts palette according to the number of colors on your model. Depending on the shape, you may not be able to change the color.</p>

13.8.2 Lamp Feature

■ Basic

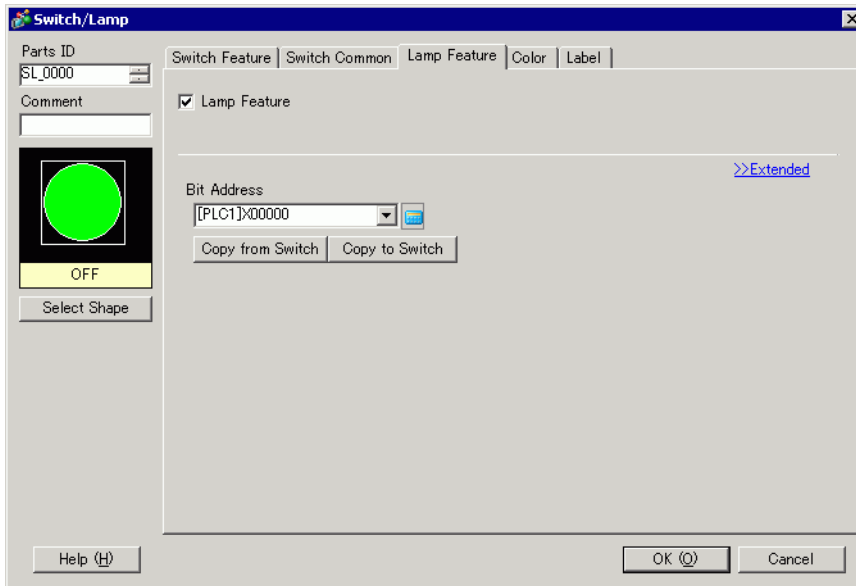

Setting	Description
Lamp Feature	Set whether or not to use the lamp feature.
Bit Address	Specify the bit address to turn ON/OFF the lamp. <ul style="list-style-type: none"> To set three or more colors for a lamp using multiple bit addresses or Word addresses, set them in the [Details] dialog box. To use multiple bit addresses: " ■ Detail (Bit Address)" (page 13-36) To use Word addresses: " ■ Detail (Word Address)" (page 13-37)
Copy from Switch	Copies the value from the [Switch Feature] tab's [Bit Address] setting to the [Lamp Feature] tab's [Bit Address]. This is used when setting a Lamp Feature and Switch Feature to the same address.
Copy to Switch	Copies the value from the [Lamp Feature] tab's [Bit Address] setting to the [Switch Feature] tab's [Bit Address]. This is used when setting a Lamp Feature and Switch Feature to the same address.

■ Detail (Bit Address)

Select this when using multiple bit addresses.

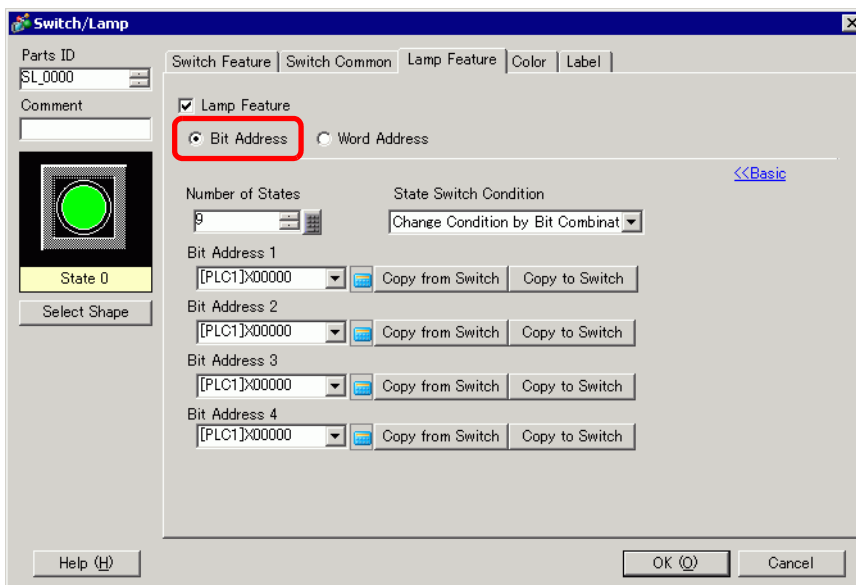

Setting	Description
Number of States	Set the number of the Lamp color states from 2 to 16. To set four colors for one lamp, the number of states is 4.
State Switch Condition	<p>Using four bit devices, one lamp displays the combination of the bit addresses' ON (1)/OFF (0) states with different colors.</p> <ul style="list-style-type: none"> • Change Condition by Bit The color of the lamp is changed according to the ON/OFF state of the individual four bit addresses. ☞ "13.3 Switching by Turning Multiple Bits ON/OFF (Up to 5 States)" (page 13-8) • Change Condition by Bit Combination The color of the lamp is changed according to the combination of the ON/OFF states of the four bit addresses. ☞ "13.4 Switching by a Combination of Multiple Bits (Up to 16 States)" (page 13-13) • This setting is disabled when [Number of States] is 2 or less.
Bit Address	<p>Specify the bit address to turn ON/OFF the lamp.</p> <ul style="list-style-type: none"> • The number of addresses to set differs according to the specified [Number of States] or [State Switch Condition].
Copy from Switch	Copies the value from the [Switch Feature] tab's [Bit Address] setting to the [Lamp Feature] tab's [Bit Address]. This is used when setting a Lamp Feature and Switch Feature to the same address.
Copy to Switch	Copies the value from the [Lamp Feature] tab's [Bit Address] setting to the [Switch Feature] tab's [Bit Address]. This is used when setting a Lamp Feature and Switch Feature to the same address.

■ Detail (Word Address)

Select this when using a Word address.

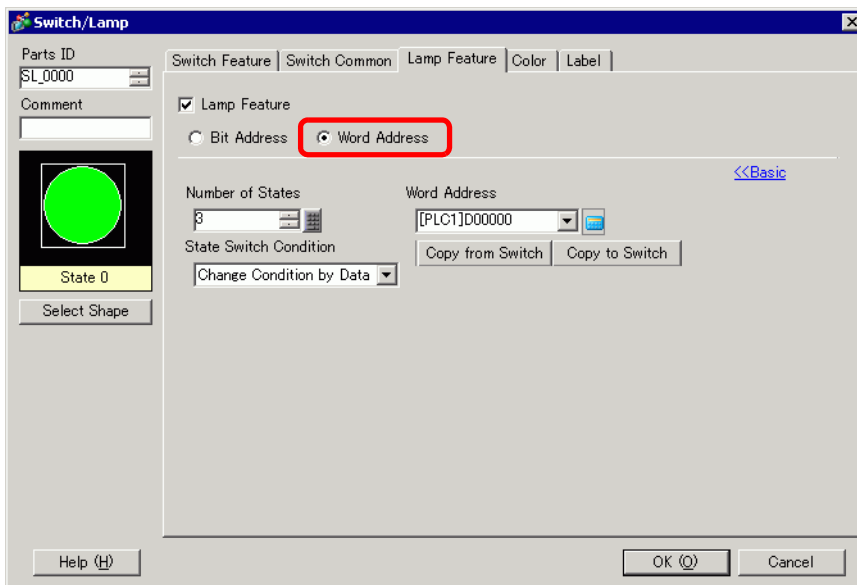

Setting	Description
Number of States	Define the number of Lamp color states, from 2 to 256. To set 17 colors for one lamp, the number of states is 17.
State Switch Condition	Using 16 bit addresses in a Word address, one lamp displays the combination of the bit addresses' ON (1)/OFF (0) states with different colors. <ul style="list-style-type: none"> • Change Condition by Bit The color of the lamp is changed according to the ON/OFF state of the individual 16 bit addresses. ☞ "13.5 Switching by the Word Address Bit Change (Bit Settings)" (page 13-19) • Change Condition by Data You can change the Lamp state by storing a value between 0 and 255. The color of the lamp changes corresponding to the ON/OFF value of the bottom 8 bits in the specified word address. You can define up to 256 different sets of colors. ☞ "13.6 Change When Word Address Value Changes" (page 13-25) • This setting is disabled when [Number of States] is 2 or less.
Word Address	Specify the Word address to turn ON/OFF the lamp.
Copy from Switch	Copies the value from the [Switch Feature] tab's [Bit Address] setting to the [Lamp Feature] tab's [Bit Address]. This is used when setting a Lamp Feature and Switch Feature to the same address.
Copy to Switch	Copies the value from the [Lamp Feature] tab's [Bit Address] setting to the [Switch Feature] tab's [Bit Address]. This is used when setting a Lamp Feature and Switch Feature to the same address.

13.8.3 Color

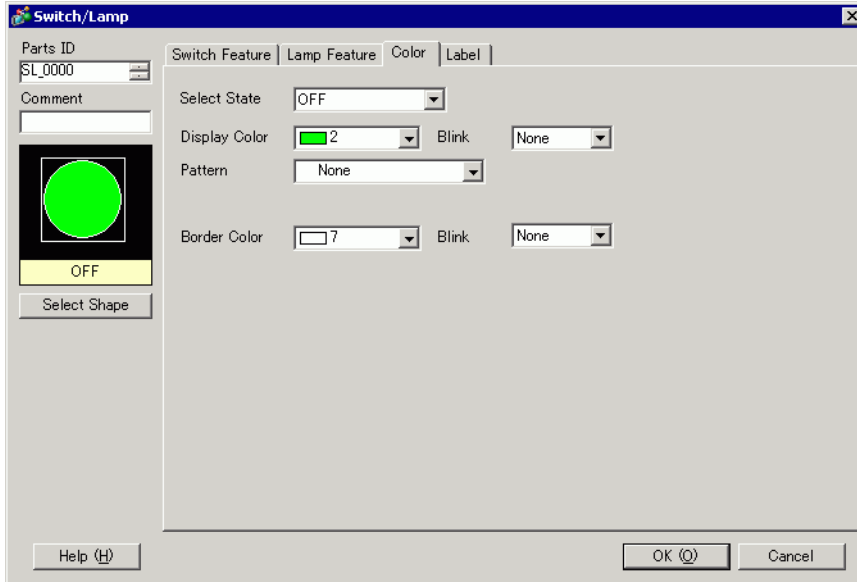

Setting	Description
Select State	<p>Select the Lamp state. Set the color for the Lamp state.</p> <ul style="list-style-type: none"> • OFF You can set the color of the Lamp when OFF. • ON You can set the color of the Lamp when ON. • State 0 to State 255 Specify the [Number of States] in the [Lamp Feature]'s detail settings, and then set the color of each of the Lamp states.
Display Color	Specify the Lamp color.
Pattern	Specify a pattern.
Pattern Color	Select the pattern color for the Lamp.
Border Color	If the Lamp is set to have a border, select a color for it.
Blink	<p>Select whether or not the part will blink, and the blink speed. You can choose different blink settings for the [Display Color], [Pattern Color], and [Border Color].</p> <ul style="list-style-type: none"> • There are cases where you can and cannot set Blink depending on the Display Unit and System Settings' [Color Settings]. ☞ "8.5.2 Setting Blinks" (page 8-49)

13.8.4 Label

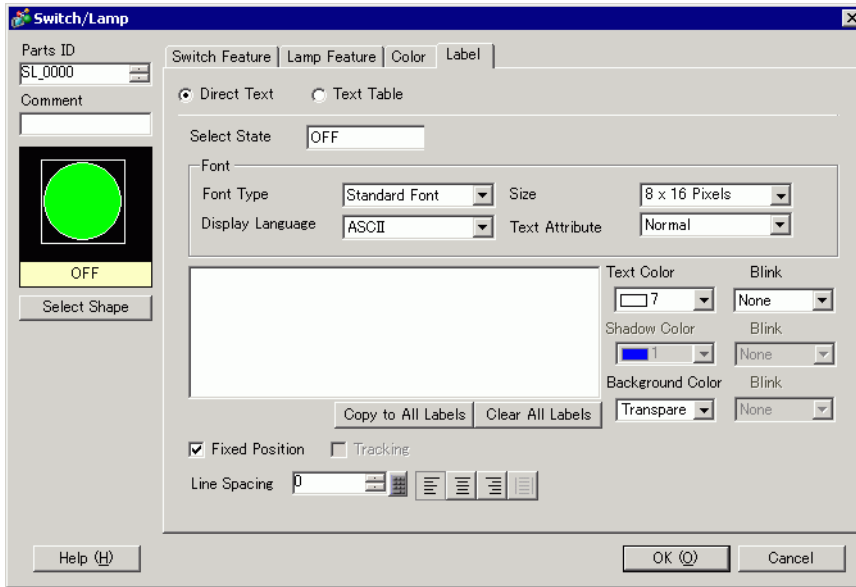

Setting	Description
Text Type	<p>Select the Label's text type.</p> <ul style="list-style-type: none"> • Direct Text Input the text into the text window, and it is placed directly as fixed text. • Text Table Use text from a previously saved Text Table. <p>☞ "17.4 Changing Languages (Multilanguage)" (page 17-16)</p>
Select State	<p>Specify the Lamp state. Set the label for the Lamp state.</p> <ul style="list-style-type: none"> • OFF You can set the label of the Lamp when OFF. • ON You can set the label of the Lamp when ON. • State 0 to 255 Specify the [Number of States] in the [Lamp Feature]'s detail settings, and then set the label of each of the Lamp states.
Font Type	<p>When [Direct Text] is selected:</p> <ul style="list-style-type: none"> • Standard Font You can select the bitmap font from [ASCII], [Japanese], [Chinese (Traditional)], [Chinese (Simplified)] or [Korean]. • The standard font will become bitmap font. The display speed is faster than with other fonts, but characters may have jagged outlines or get out of shape if enlarged/reduced too much. • The Japanese and ASCII standard fonts are transferred to the GP. To use the Chinese (Simplified), Korean, or Chinese (Traditional) standard font, you must add the font in [System Settings/Font]. <p>☞ "6.2 Defining Stroke Font and Standard Font" (page 6-3)</p>

Continued

Setting	Description
Font Type	<ul style="list-style-type: none"> • Stroke Font You can select the vector font from [ASCII], [Japanese], [Chinese (Traditional)], [Chinese (Simplified)], [Korean], [Cyrillic], or [Thai]. • The stroke font will become vector font. Characters are displayed with smooth outlines if enlarged, but the display speed is slower than with the standard font. • The ASCII stroke font will be transferred to the GP. To use the Japanese, Chinese (Simplified), Korean, Chinese (Traditional), Cyrillic or Thai stroke font, you must add the font in [System Settings/Font]. ☞ "6.2 Defining Stroke Font and Standard Font" (page 6-3) • Image Font Displays a Windows font as bitmap data. ☞ "6.3 Image Font" (page 6-14) <p>When [Text Table] is selected: Select between Standard Font and Stroke Font. If you select [Stroke Font], the [Automatically Adjust Text Size] option appears. By selecting this option, the font size adjusts automatically to fit the text in the part.</p>
Size	<p>Select the text size. Each font type has a different size range.</p> <ul style="list-style-type: none"> • Size Standard Font: 8 x 8 dot standard unit, 1 to 8 times (8 x 8 to 64 x 64 dot) 8 x 16 dot standard unit, 1 to 8 times (8 x 16 to 64 x 128 dot) Stroke Font: 6 to 127 If you select [Automatically Adjust Text Size], you can adjust the [Maximum Size] and [Minimum Size]. • Fixed Size Available when [Standard Font] is selected. You can choose between 6x10 dots, 8x13 dots, or 13x23 dots. When using 6x10 fonts, you cannot set the [Text Attribute] to [Bold].
Display Language	<p>Choose a text display language from [ASCII], [Japanese], [Chinese (Traditional)], [Chinese (Simplified)], [Korean], [Cyrillic], or [Thai].</p>
Text Attribute	<p>Each font type has a different range of styles. Standard Font: Choose from [Standard], [Bold], [Shadow]. Stroke Font: Choose from [Standard], [Bold], [Outline].</p>
Select Font	<p>If [Image Font] is selected from the [Font Type] menu, set [Font], [Font Style], [Text Size], and [Script].</p> <ul style="list-style-type: none"> • Because Image Font uses a standard Windows popup menu, the available font types, styles, and languages depend on your OS.
Text (Input Box)	<p>If [Direct Text] is selected, input the text.</p>
Text Color	<p>Set the display color for the text. ☞ "8.5.1 Setting Colors" (page 8-42)</p>

Continued

Setting	Description
Background Color	Set the background color for the text. ☞ "8.5.1 Setting Colors" (page 8-42)
Shadow Color	If the [Font Type] menu - [Standard Font] command and the [Text Attribute] menu - [Shadow] command are selected, set the color for the text shadow. ☞ "8.5.1 Setting Colors" (page 8-42)
Blink	Select whether or not the part will blink, and the blink speed. You can choose different blink settings for the [Text Color], [Shadow Color], and [Background Color]. <ul style="list-style-type: none"> • There are cases where you can and cannot set Blink depending on the Display Unit and System Settings' [Color Settings]. ☞ "8.5.2 Setting Blinks" (page 8-49)
Copy to All Labels	Copies the text and fonts to all states in the [Select State] list. <ul style="list-style-type: none"> • This can only be set if the Lamp Feature is used.
Clear All Labels	Clears the text in all states. All other label settings such as the Font Type and Color remain the same. <ul style="list-style-type: none"> • This can only be set if the Lamp Feature is used.
Fixed Position	Set whether or not to fix the Label's display position in the center of the part.
Tracking	After the part is placed, any changes made to the Label's size or position will be copied to all the other states. To change the size or position of an individual state's Label without affecting the other states, ensure that this option is not checked. <ul style="list-style-type: none"> • When [Fixed Position] is set, the [Tracking] setting cannot be used. • When [Text Type] is set to [Text Table], the [Tracking] setting cannot be used.
Line Spacing	Set a row spacing from 0 to 255. This is only applicable when multiple lines are inputted in the [Text]. This option cannot be used when the [Font Type] is set to [Image Font].
Align	Aligns the inputted text. If the text is two lines or more, you can select [Align Left], [Align Right], or [Align Center]. When the [Font Type] is set to [Image Font], [Align on Both Sides] can also be selected.

