

7 | Device/PLC Communication

This chapter explains how to use the display unit to communicate with multiple devices/PLCs. Procedures for stopping communications and changing devices/PLCs are also discussed.

Please start by reading “7.1 Settings Menu” (page 7-2) and then turn to the corresponding page.

7.1	Settings Menu	7-2
7.2	Connecting to Multiple Device/PLCs.....	7-3
7.3	Disconnecting Multiple Connected Devices/PLCs	7-11
7.4	Changing a Device/PLC.....	7-17
7.5	Settings Guide.....	7-28
7.6	Restrictions	7-34

7.1 Settings Menu

Connecting to Multiple Device/PLCs	
	<ul style="list-style-type: none"> Setup Procedure (page 7-4) Introduction (page 7-3)
Disconnecting Multiple Connected Devices/PLCs	
	<ul style="list-style-type: none"> Setup Procedure (page 7-11) Introduction (page 7-11)
<p>To stop the GP from scanning for a device/PLC, set the communication bit to OFF.</p>	
Changing a Device/PLC	
	<ul style="list-style-type: none"> Setup Procedure (page 7-18) Introduction (page 7-17)

7.2 Connecting to Multiple Device/PLCs

7.2.1 Introduction

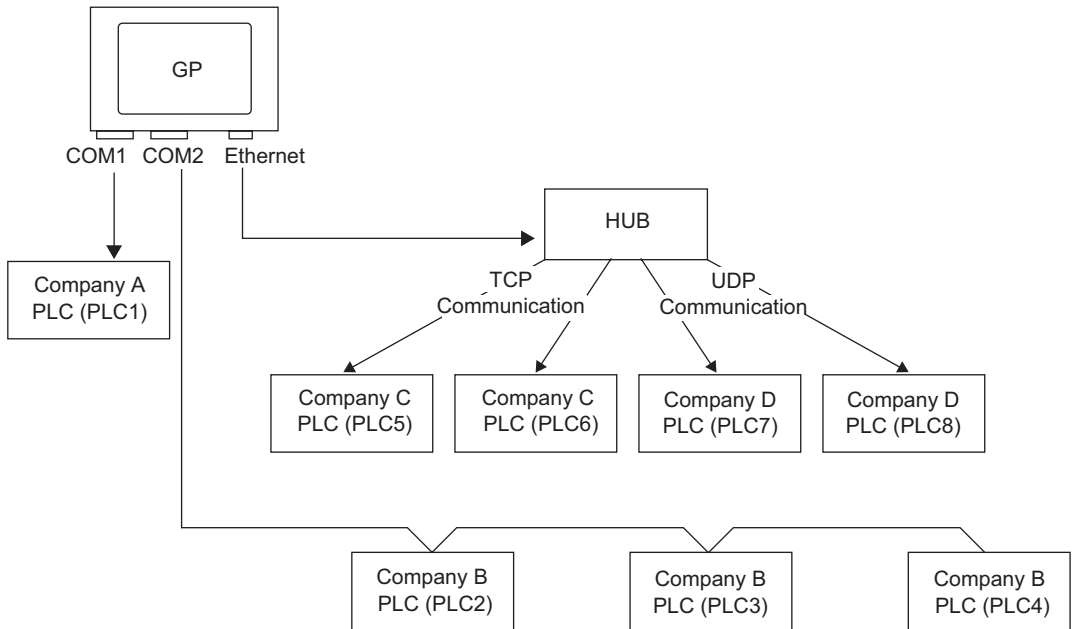

Multiple devices/PLCs can be connected simultaneously to one GP using four drivers (COM1, COM2, and Ethernet (UDP/TCP)).

NOTE

- There are two types of models: one model can have two drivers and one model can have four drivers.
 ☞ “1.3 List of Supported Functions by Device” (page 1-5)

7.2.2 Setup Procedure

NOTE

- Please refer to the settings guide for details.
 ☞ “5.14.2 [New] Settings Guide” (page 5-78)

For example, COM1: Company A's PLC, PLC1 (Omron, CS/CJ Series HOST Link)
 COM2: Company B's PLCs, PLC2, PLC3, PLC4 (3 units of Mitsubishi, A Series Computer Link). Configure settings to add these PLCs.

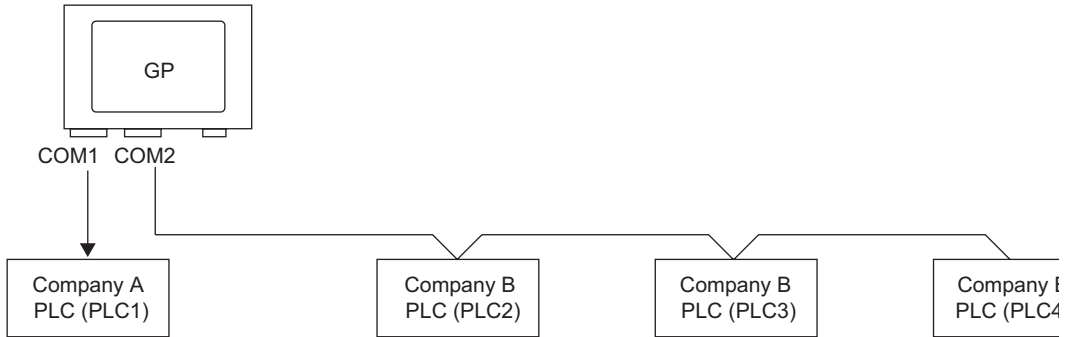

- 1 From the [Project (F)] menu, point to [System settings (C)] and select [Device/PLC Settings] or click . The [Device/PLC] screen appears.

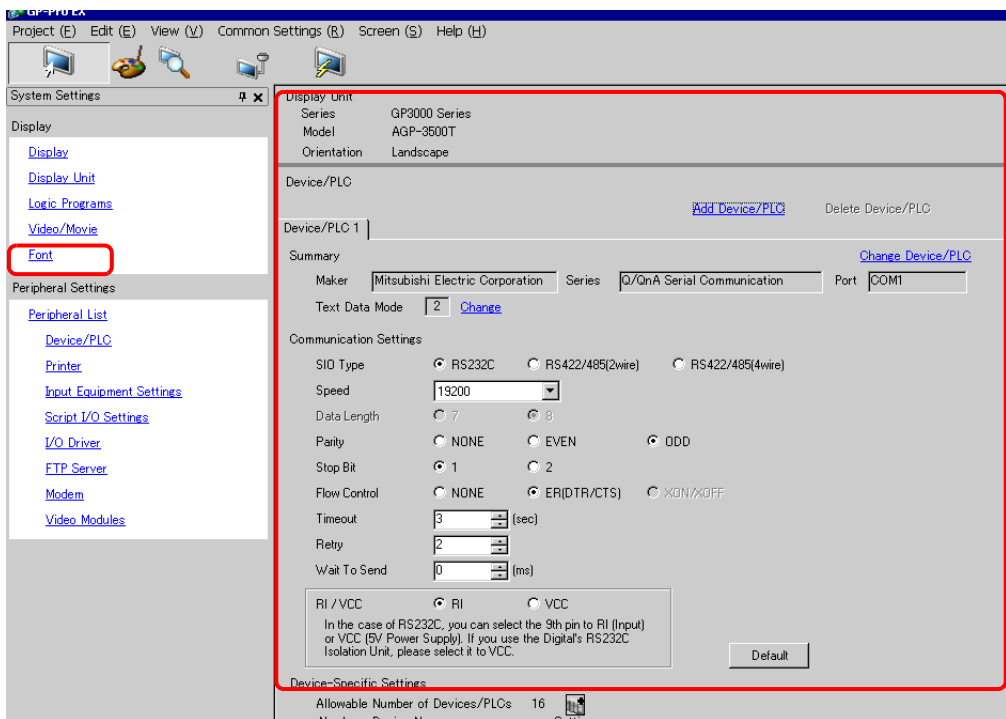

2 Click [Add Device/PLC].

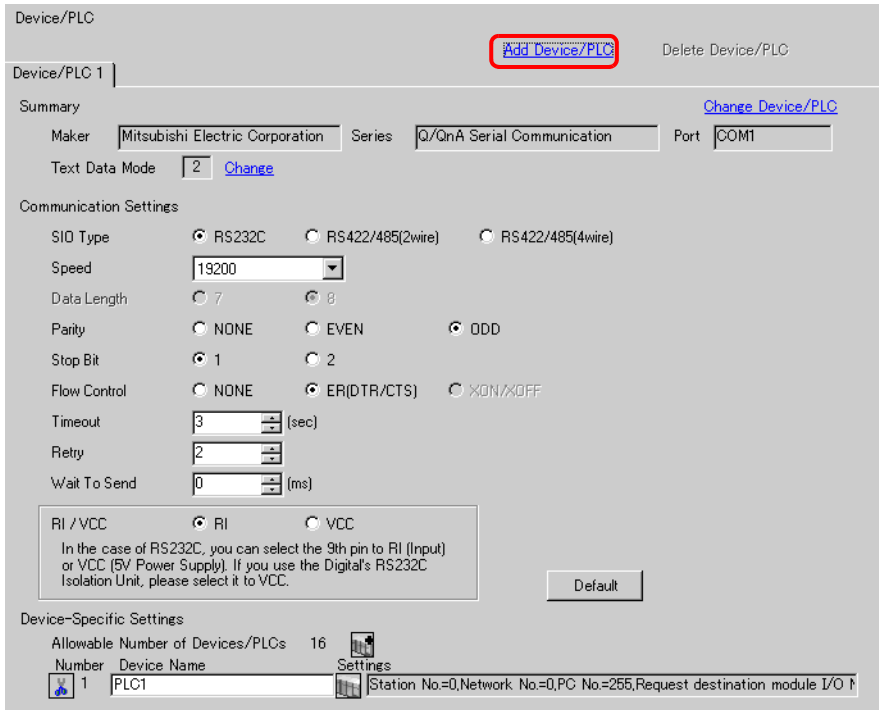

3 Select options from the [Maker], [Driver], and [Port] boxes for the PLC you want to add.

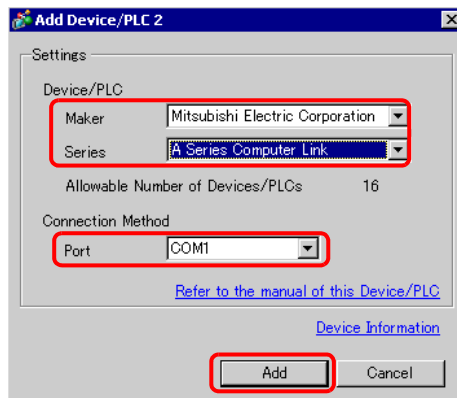

NOTE

- Make sure not to choose a port that is already used by another PLC. If the port has multiple PLCs,  appears to the right of the [Device/PLC] screen's [Port] label.

4 When the [Device/PLC2] tab appears, click [Add Device Button]  and add two PLCs.

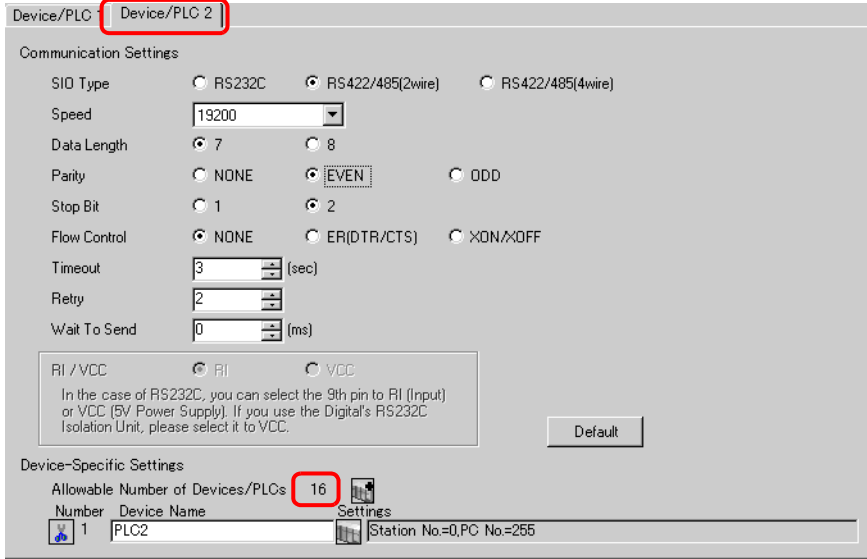

NOTE • Every time [Add Device]  is clicked, one PLC is added.

5 Set the name of each added PLC with up to 20 single-byte characters.

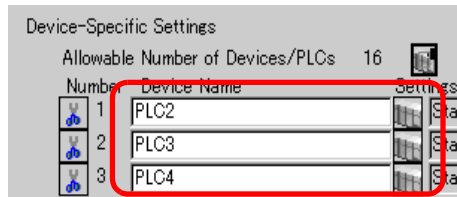

NOTE • When adding the desired [Device Name], use different names for each PLC.

6 Click [Device/PLC] . The [Individual Display] dialog box appears. Set each corresponding PLC. (The following image shows the [Individual Display] dialog box used for the Mitsubishi A Series Computer Link type.)

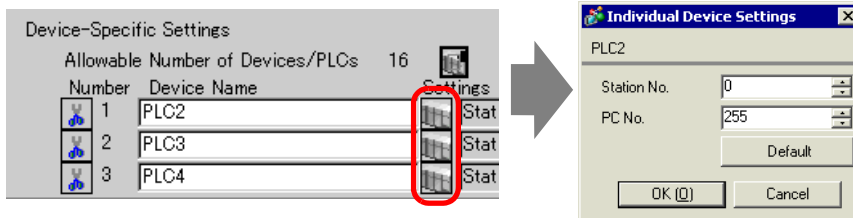

NOTE • The settings in the [Individual Device Settings] dialog box vary depending on the PLC. Confirm the details of the PLC settings in "GP-Pro EX Device/PLC Manual".

7 Confirm that multiple PLCs have been added.

7.2.3 Structure

■ Multiple PLC Connection Methods

◆ Direct Access Method

- Multiple PLCs can be connected.

(1) When using COM1 and COM2

For example, Company A's driver (serial communication) is set to COM1, and Company B's driver is set to COM2 (serial communication).

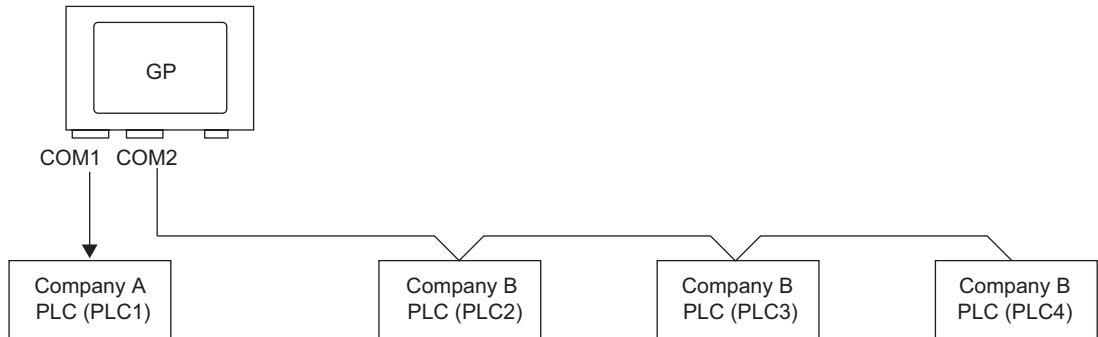

NOTE

- A different driver can be designated for each COM port. However, each COM port can only have a single driver.
- You can connect multiple devices with the same driver to each COM Port. However, the allowable number of devices/PLCs varies depending on the driver. Refer to the "GP-Pro EX Device/PLC Manual" for the allowable number of devices/PLCs.

(2) When using COM1 and Ethernet port ([UDP]/[TCP] communication).

For example, Company A's driver (serial communication) is set to COM1, and Company B, C, and D's drivers are set to the Ethernet port (Ethernet communication).

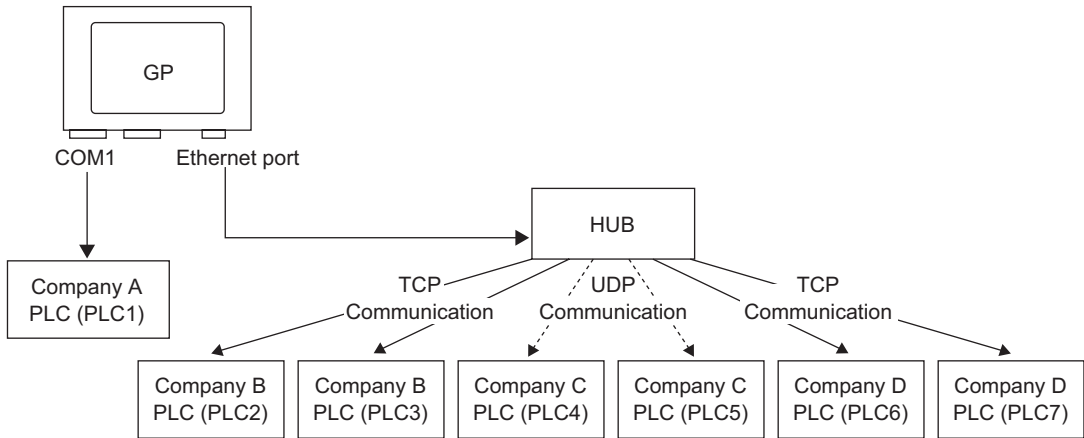

NOTE

- A maximum of four drivers can be used by the ports. They can be configured one driver per COM port and the remainder used by the Ethernet port, or all four can be used by the Ethernet port and none by the COM ports. In the above example, COM1 has one driver set up (Company A's PLC), so the Ethernet port can handle 3 additional types of drivers (Company B, C, and D).

NOTE

- When using an Ethernet communication driver with multiple connections, [UDP] or [TCP] can not be set up in the same driver. For example, when [Device/PLC1] has been set to MELSEC A Ethernet [UDP] type, [Device/PLC2] cannot be set to MELSEC A Ethernet [TCP] type.

◆ **Direct Access Method + Memory Link Method**

- Devices/PLCs and hosts (PCs, Microcomputer boards, etc.) can be connected at the same time.

(3) When using Direct Access Method and Memory Link Method

For example, Company A's PLC is connected to COM1 by direct access method, and the microcomputer board is connected to COM2 by memory link method.

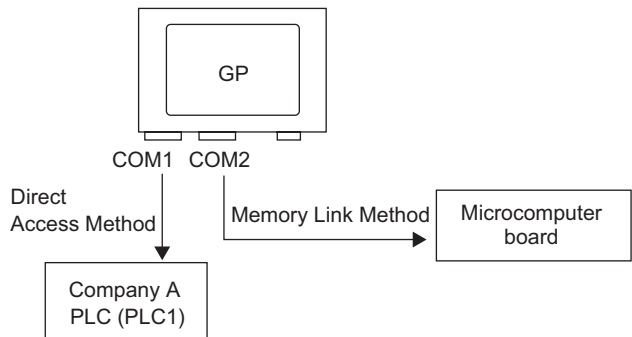

■ System Data Area/LS Area for Use with Multiple Devices/PLCs

Refer to the “A.1.4.4 Device/PLC System Data Area Allocation Procedure” (page A-22) or “GP-Pro EX Device/PLC manual” for details on the system data area.

◆ Direct Access Method

When multiple PLCs are connected to the GP, the system data area can only have one PLC connected to it.

For example, in the following image, when four PLCs are connected to the GP, only one can be set to the system data area.

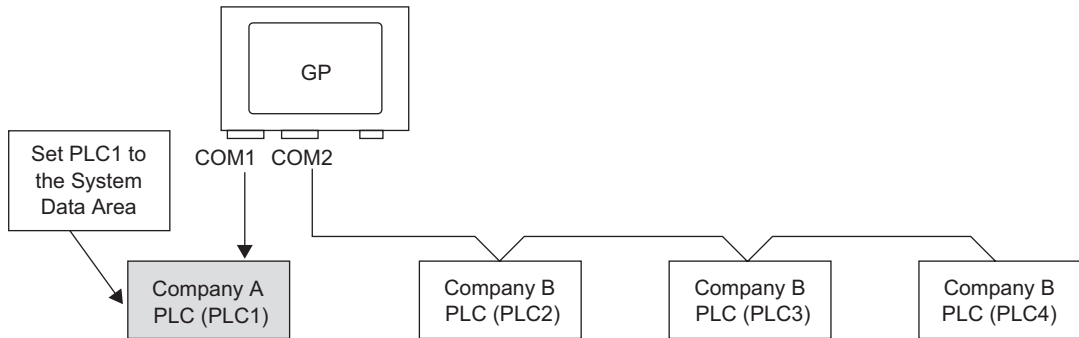

◆ **Direct Access Method + Memory Link Method**

When communicating by direct access and memory link, each method uses a separate LS area. However, the system data area, the special relay area, and the LS9000 area are shared. For example, in the following image, a PLC and microcomputer board are both connected to the GP, the GP has a direct access method LS area and a memory link method LS area.

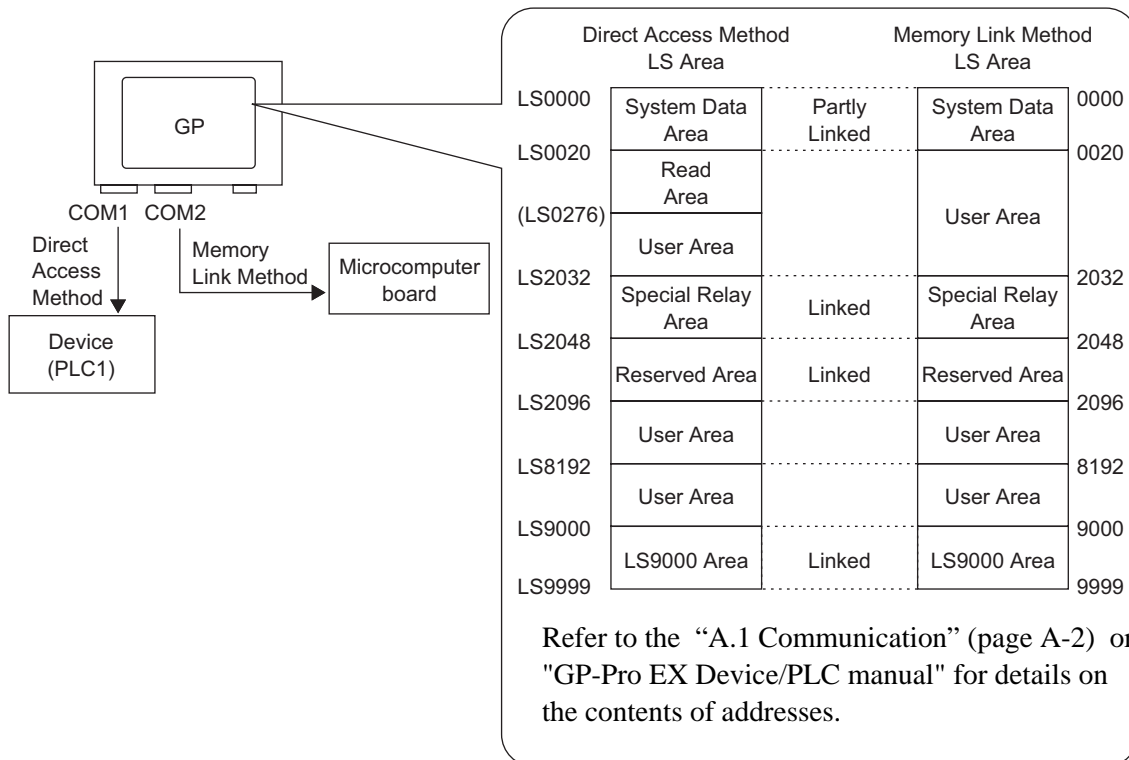

7.3 Disconnecting Multiple Connected Devices/PLCs

7.3.1 Introduction

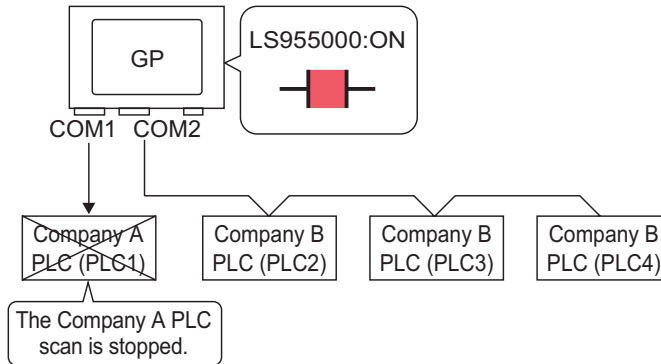

To stop the GP from scanning for a device/PLC, set the communication bit to OFF.

7.3.2 Setup Procedure

NOTE

- Please refer to the settings guide for details.
 - ☞ "11.14.1 Bit Switch" (page 11-41)
 - ☞ "7.5 Settings Guide" (page 7-28)
- For details of the part placement method and the address, shape, color, and label setting method, refer to the "Part Editing Procedure".
 - ☞ "9.6.1 Editing Parts" (page 9-38)

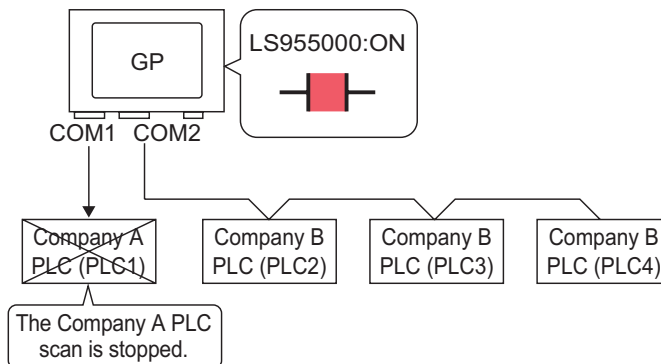

To stop the GP from scanning for a device/PLC, set the communication bit to OFF.

■ Stop Communications

Create a touch switch to reverse the ON/OFF bit address that controls each device/PLC's communication scan.

- 1 On the [Parts (P)] menu, point to [Switch Lamp], and select [Bit Switch (B)], or click  to place a lamp on the screen.
- 2 Double-click the placed Switch part and the settings dialog box appears.

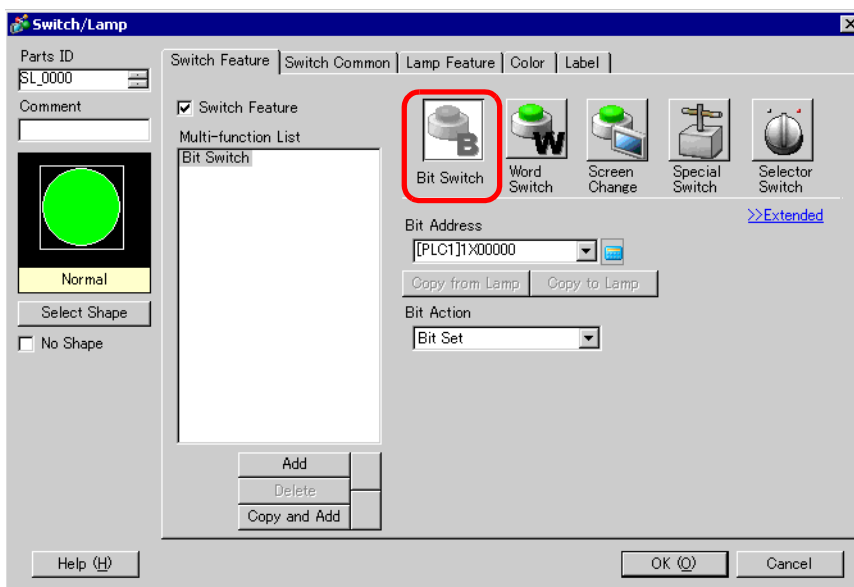

- 3 Select the Switch shape from [Select Shape].

- 4 Set the address (for example, LS955000) to control the start/stop of communication scan in [Bit Address].

Click the icon to display an address input keypad.

Select [#INTERNAL] for the [Device/PLC] and "LS" for the Device, input "955000" in the address, and press the "Ent" key.

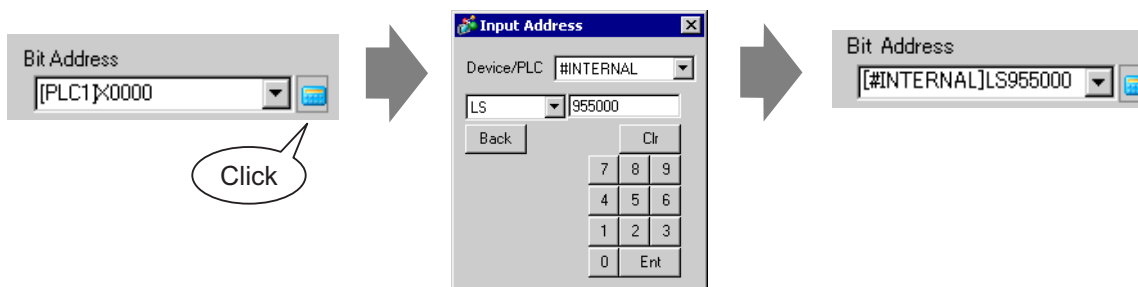

NOTE

- Use the internal device address LS9550 - LS9557 to control the start or stop of the communication scan.

LS Area	
LS9550	Driver 1 Machine 1 to 16
LS9551	Driver 1 Machine 17 to 32
LS9552	Driver 2 Machine 1 to 16
LS9553	Driver 2 Machine 17 to 32
LS9554	Driver 3 Machine 1 to 16
LS9555	Driver 3 Machine 17 to 32
LS9556	Driver 4 Machine 1 to 16
LS9557	Driver 4 Machine 17 to 32
LS9558	Reserved
LS9559	Reserved

For example,

You can control up to 16 communication scans of driver 1 using LS9550. [LS9550]

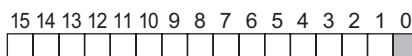

Bit 0: Scans ON/OFF Driver 1 PLC 1.

Turning ON bit 0 stops the scan of the first device/PLC controlled by Driver 1. Turn OFF Bit 0 to resume the scan.

- You cannot stop the communication scan of a device specified with the System Area Start Address. However, if you are not using the System Data Area, you can stop the communication scan.
- ☞ “5.14.6 [System Settings] Setting Guide ◆ System Area Settings” (page 5-135)
- If you designate a 32-bit device in [System Area Start Address], you can set 32 bits in the LS area. However, you can use only the lower 16 bits to control the communication scan.
- When you turn OFF the communication scan, the displayed device/PLC data will remain. However, if you change screens and then display the screen again, the device/PLC data will not be displayed.

5 Choose [Bit Invert] from [Bit Action].



6 As needed, set the Switch color and display text on the [Color] tab and [Label] tab, and click [OK].

■ Confirming the Communication State

Create a lamp to acknowledge when a communication scan is running.

- 1 From the [Parts (P)] menu, point to [Switch Lamp] and select [Lamp] or click  to place a lamp on the screen.
- 2 Double-click the placed Lamp part and the settings dialog box appears.

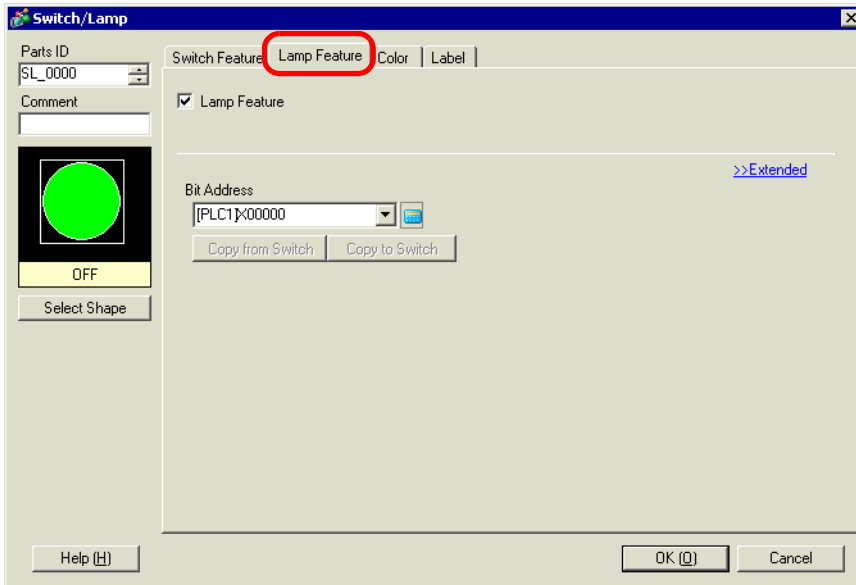

- 3 Select the lamp shape in [Select Shape].

- 4 Set the bit address to acknowledge the exclusive state of the communication scan in [Bit Address] (For example, LS956000)

Click the icon to display an address input keypad.

Select [#INTERNAL] for the [Device/PLC] and "LS" for the Device, input "956000" in the address, and press the "Ent" key.

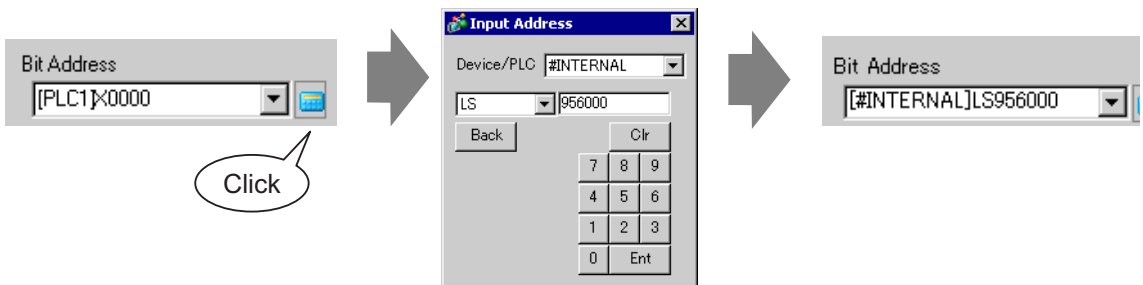

NOTE

- Use the internal device address LS9560 - LS9567 to acknowledge the execution or stop of the communication scan.

LS Area	
LS9560	Driver 1 Machine 1 to 16
LS9561	Driver 1 Machine 17 to 32
LS9562	Driver 2 Machine 1 to 16
LS9563	Driver 2 Machine 17 to 32
LS9564	Driver 3 Machine 1 to 16
LS9565	Driver 3 Machine 17 to 32
LS9566	Driver 4 Machine 1 to 16
LS9567	Driver 4 Machine 17 to 32
LS9568	Reserved
LS9569	Reserved

For example,

You can acknowledge up to 16 communication scans of driver 1 using LS9560.

[LS9560]

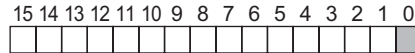

Bit 0: OFF when the first I/O Driver1 is scanning. ON when the scan is stopped.

- If you designate a 32-bit device in [System Area Start Address], you can set 32 bits in the LS area. However, you can only use the lower 16 bits to acknowledge the execution of the communication scan.

5 Click the [Color] tab and set the Lamp display colors. Set a [Display Color], [Pattern] and [Border Color] for each case where the [Select State] is ON or OFF.

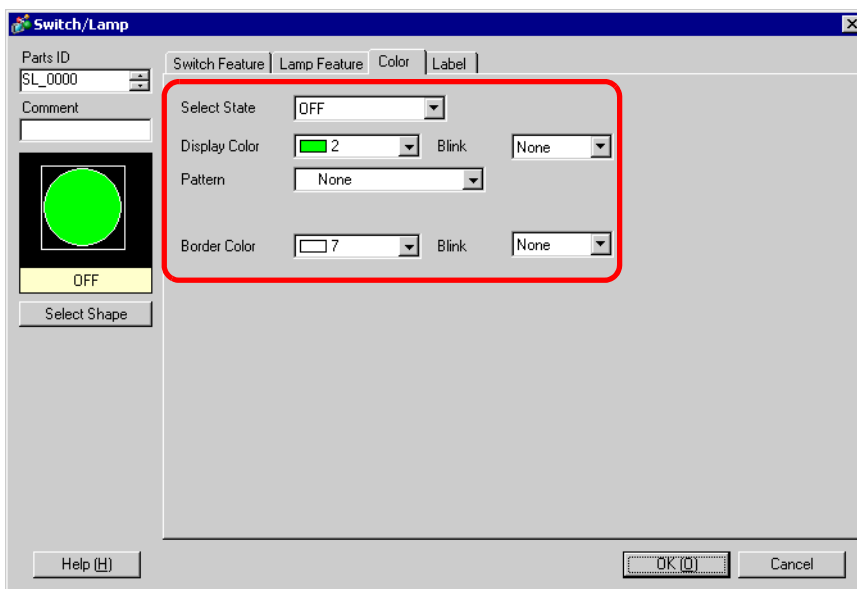

6 Click the [Label] tab and set the label displayed at the top of the lamp parts. Specify the font and size, input display text into the rectangle field, and click [OK].

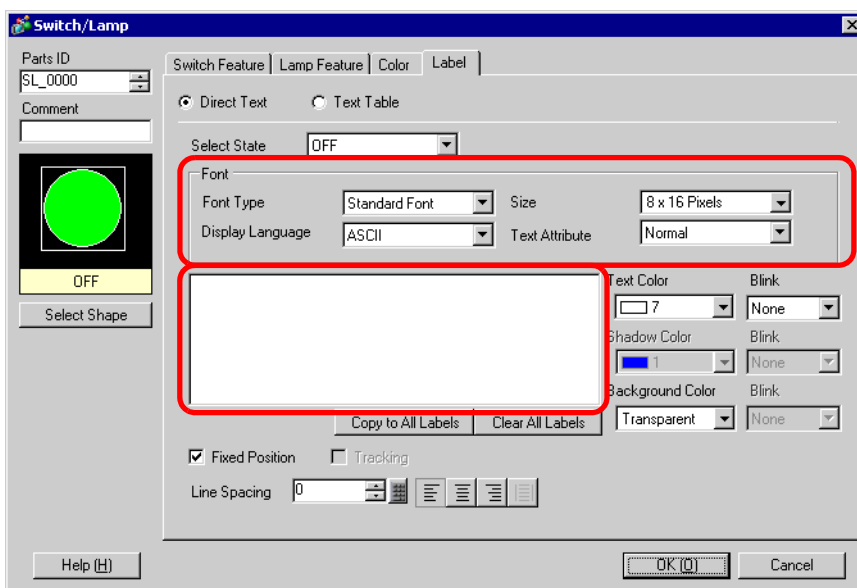

7.4 Changing a Device/PLC

7.4.1 Introduction

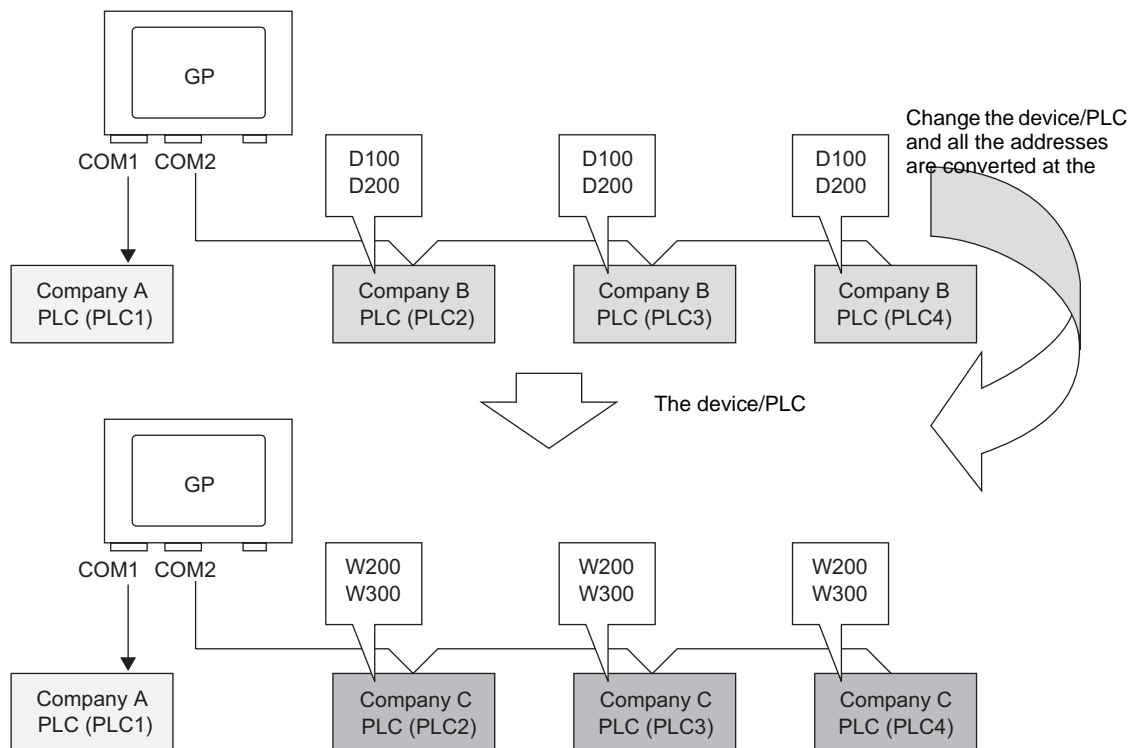

When changing the type of PLC, addresses can be modified for multiple PLCs at the same time.

There are two methods for converting addresses when changing a device/PLC model: converting the PLC type without designating an Address Conversion Range, or Converting the PLC type and Designating an Address Conversion Range.

7.4.2 Setup Procedure

■ Converting the PLC type without designating an Address Conversion Range

Change the type of device without specifying an address conversion pattern at the time of conversion.

NOTE

- Please refer to the settings guide for details.
☞ “7.5.1 [Change Device/PLC] Settings Guide” (page 7-28)
-

For example,

COM1: Company A's PLC, PLC1 (for example, Omron, CS/CJ Series HOST Link)
COM2: Company B's PLCs, PLC2, PLC3, PLC4 (for example, 3 units of Mitsubishi, A Series Computer Link)

Device Conversion

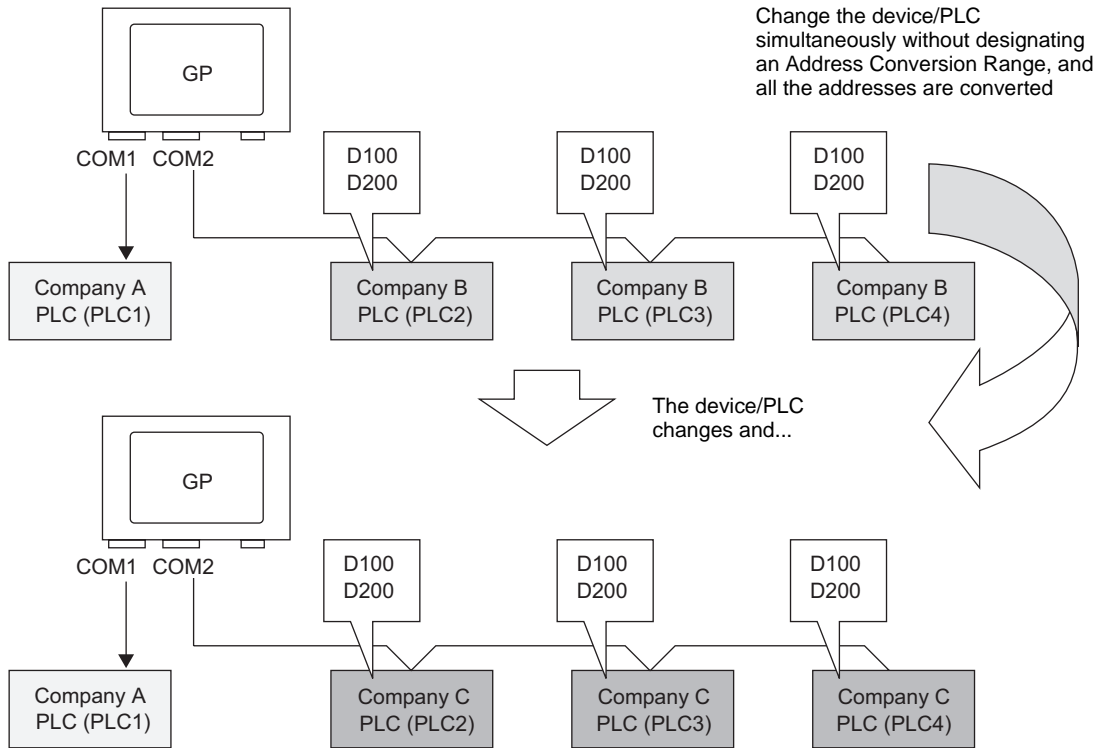

COM1: Company A's PLC, PLC1 (for example, Omron, CS/CJ Series HOST Link)
COM2: Company C's 3 PLCs, (for example, 3 units of Yokogawa Electric Corp., Computer Link SIO)

**NOTE**

- If there is no Convert Destination device code, the address may not display correctly. After converting a device/PLC, confirm all device addresses used in the project and correct the relevant addresses.

Changing a Device/PLC

- 1 From the [Project (F)] menu, select [System Settings (C)] or click  and click the System Settings window's [Device/PLC]. The following [Device/PLC] screen appears.

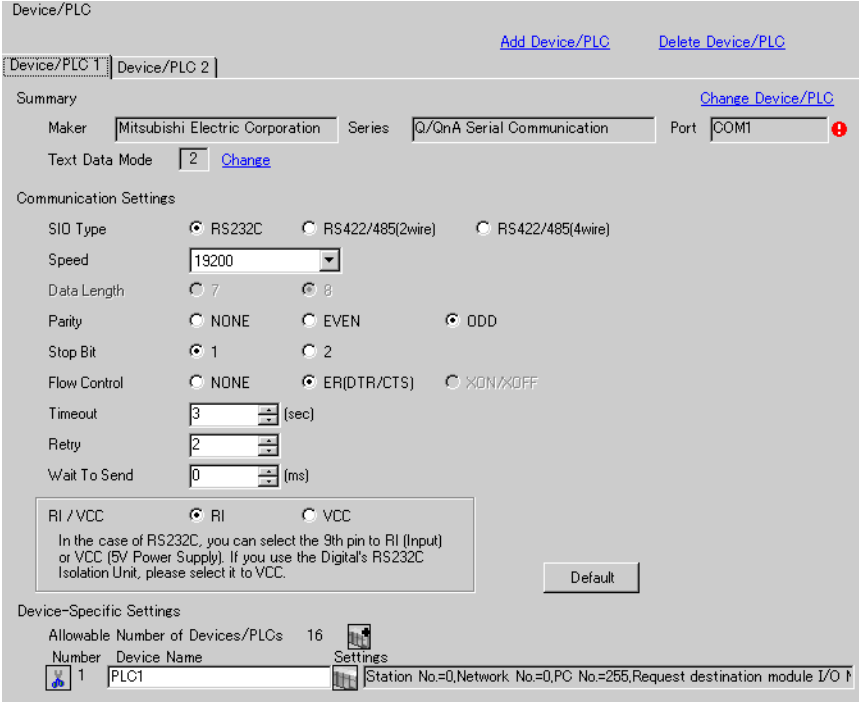

Device/PLC

[Add Device/PLC](#) [Delete Device/PLC](#)

Device/PLC 1 | Device/PLC 2

Summary [Change Device/PLC](#)

Maker Series Port 

Text Data Mode [Change](#)

Communication Settings

SIO Type RS232C RS422/485(2wire) RS422/485(4wire)

Speed

Data Length 7 8

Parity NONE EVEN ODD

Stop Bit 1 2

Flow Control NONE ER(DTR/CTS) XON/XOFF

Timeout (sec)

Retry

Wait To Send (ms)

RI / VCC RI VCC

In the case of RS232C, you can select the 9th pin to RI (Input) or VCC (5V Power Supply). If you use the Digital's RS232C Isolation Unit, please select it to VCC.

[Default](#)

Device-Specific Settings

Allowable Number of Devices/PLCs 16 

Number	Device Name	Settings
1	PLC1	Station No.=0, Network No.=0, PC No.=255, Request destination module I/O

- 2 Click the [Device/PLC2] tab, and click [Change Device/PLC].

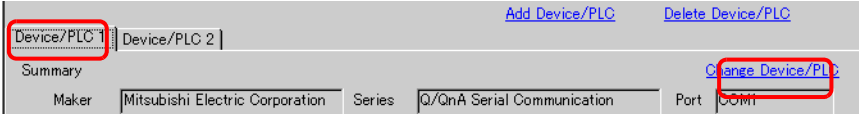

Device/PLC

[Add Device/PLC](#) [Delete Device/PLC](#)

Device/PLC 1 | **Device/PLC 2**

Summary [Change Device/PLC](#)

Maker Series Port

3 When the [Change Device/PLC] dialog box appears, set the [Maker] and [Series] of the device/PLC you want to change to.

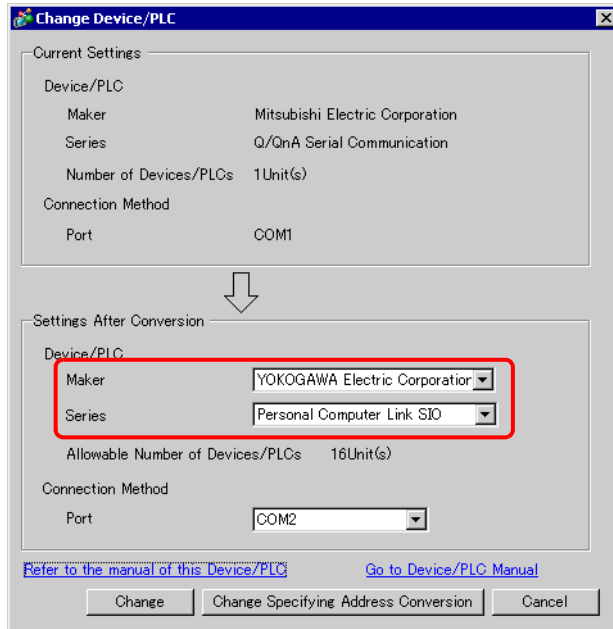

4 Click [Change].

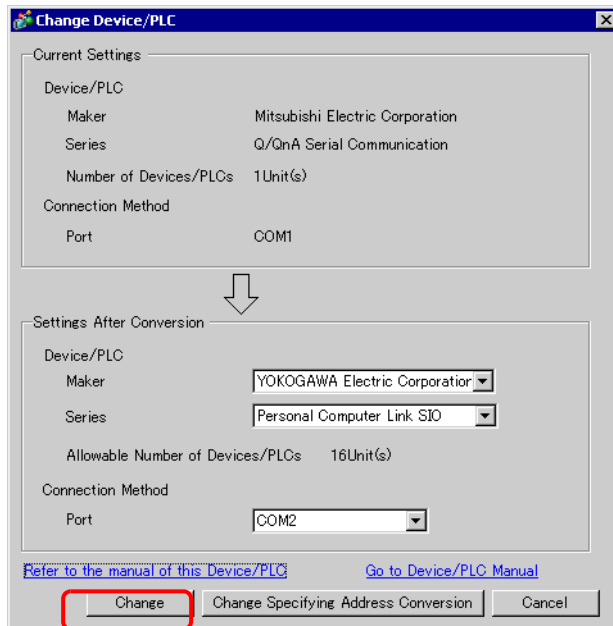

5 The following message appears. Click [OK] and the settings are complete.

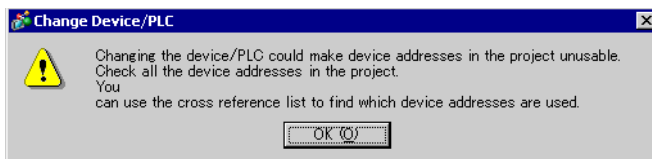

NOTE

- If you change the device/PLC by clicking the [Change] button in the [Change Device/PLC] dialog box, the address conversion pattern may not display correctly if there is no device code at the destination. Confirm all device addresses used in the project and correct the relevant addresses.
- After converting a device/PLC, any parts, D-Scripts, Alarms, etc., must have their device addresses set again. Save any screens that use a Special Switch set to [Screen Change].
- If using an Ethernet communication driver when converting multiple device/PLCs, [UDP] and [TCP] cannot be set up in the same driver. For example, when [Device/PLC 1] has been set to MELSEC A Ethernet [UDP] type, [Device/PLC 2] cannot be set to MELSEC A Ethernet [TCP] type.

■ Changing Device Type using Address Conversion Pattern

Change the type of device by specifying an address conversion pattern. Designate the previous address range and the top address of the destination device/PLC.

NOTE

- Please refer to the settings guide for details.
 - ☞ “7.5.1 [Change Device/PLC] Settings Guide” (page 7-28)
 - ☞ “7.5.2 [Address Conversion Method Specification] Settings Guide” (page 7-29)

For example,

COM1: Company A's PLC, PLC1 (for example, Omron, CS/CJ Series HOST Link)
 COM2: Company B's PLCs, PLC2, PLC3, PLC4 (for example, 3 units of Mitsubishi, A Series Computer Link)

Device Conversion



COM1: Company A's PLC, PLC1 (for example, Omron, CS/CJ Series HOST Link)
 COM2: Company C's 3 PLCs, (for example, 3 units of Yokogawa Electric Corp., Computer Link SIO)

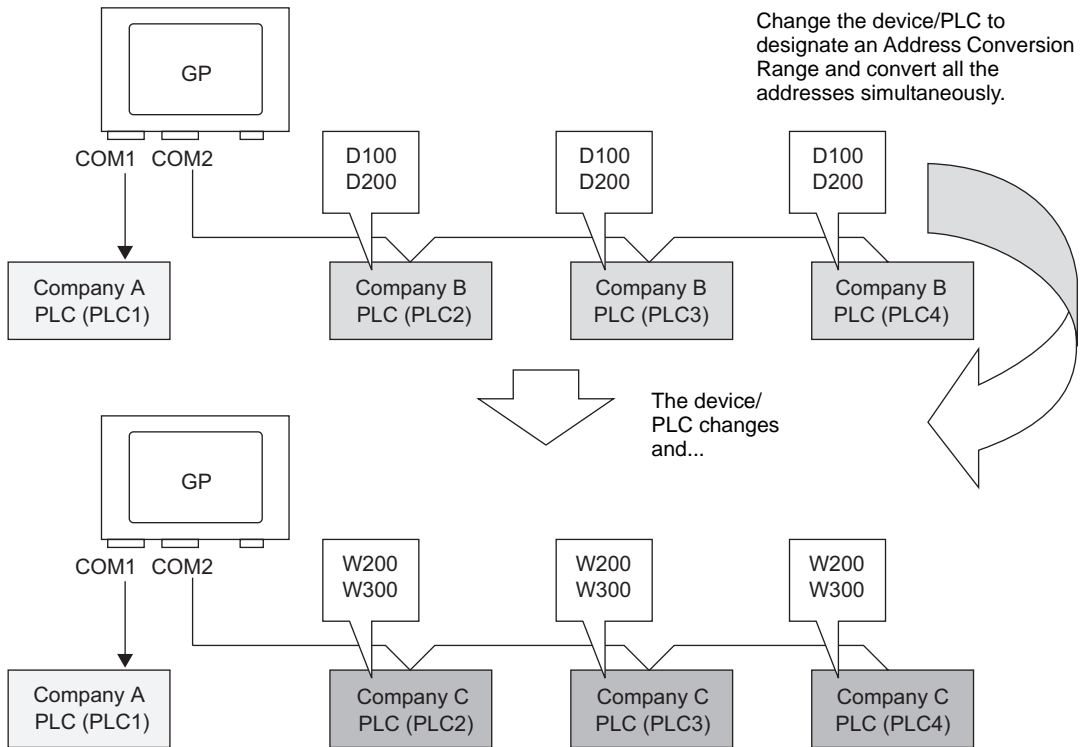

1 From the [Project (F)] menu, point to [System settings (C)] and select [Device/PLC Settings] or click . The [Device/PLC] screen appears.

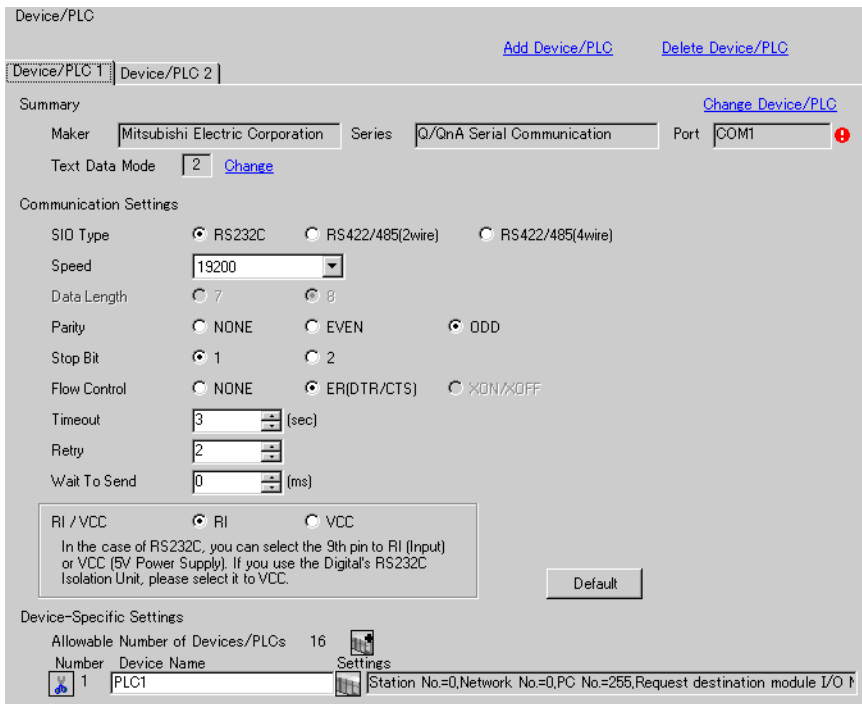

2 Click the [Device/PLC 2] tab, and click [Change Device/PLC].



3 When the [Change Device/PLC] dialog box appears, set the [Maker] and [Series] of the device/PLC you want to change to.

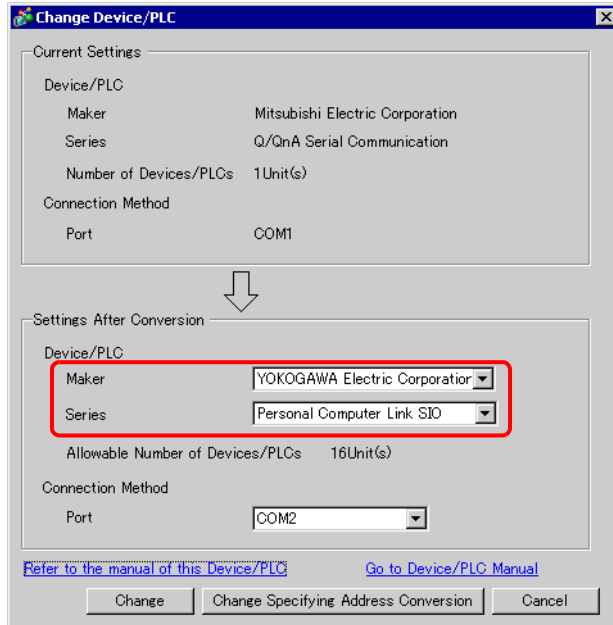

4 Click [Change Specifying Address Conversion].

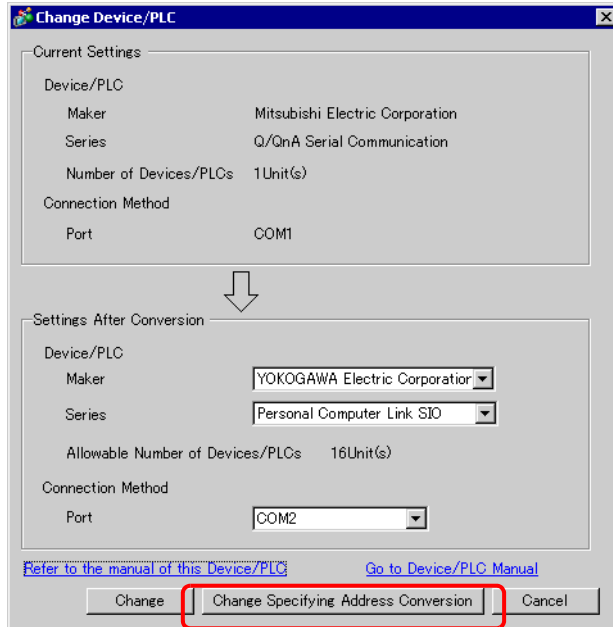

5 When the [Address Conversion Method Specification] dialog box appears, click [Add].

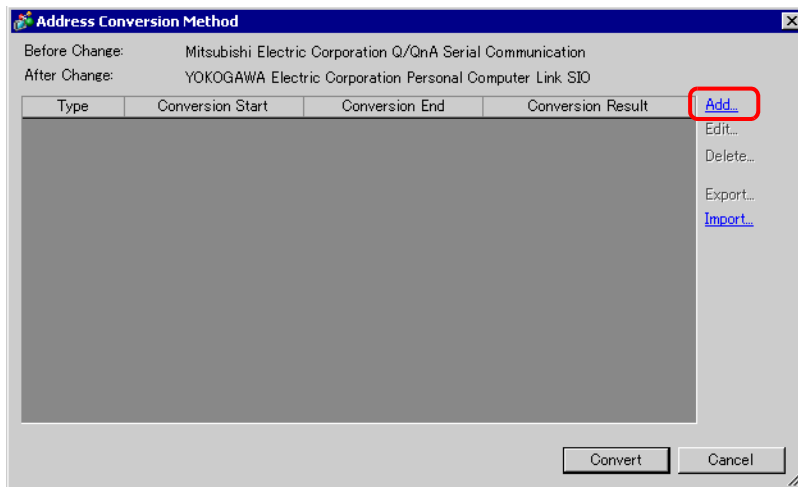

- 6 When the [Register Address Conversion Pattern] dialog box appears, set the [Address Type], the Before Conversion [Start] and [End] address, and the After Conversion [Start] address.

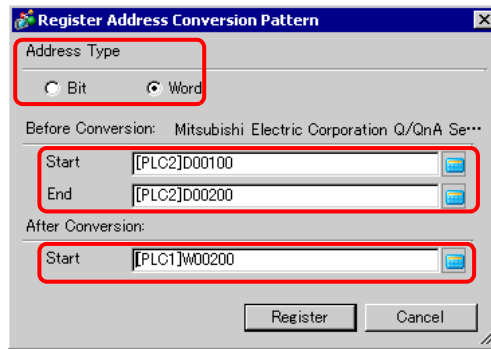

- 7 Click [Register].

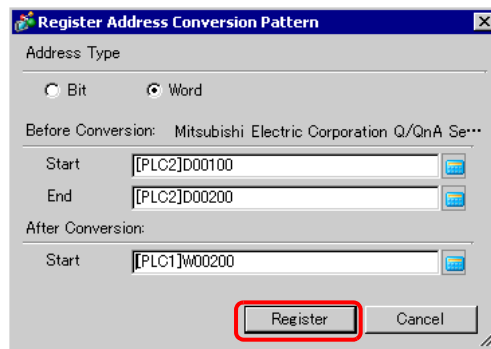

- 8 When the [Address Conversion Method Specification] dialog box appears and the conversion pattern is added, click [Convert].

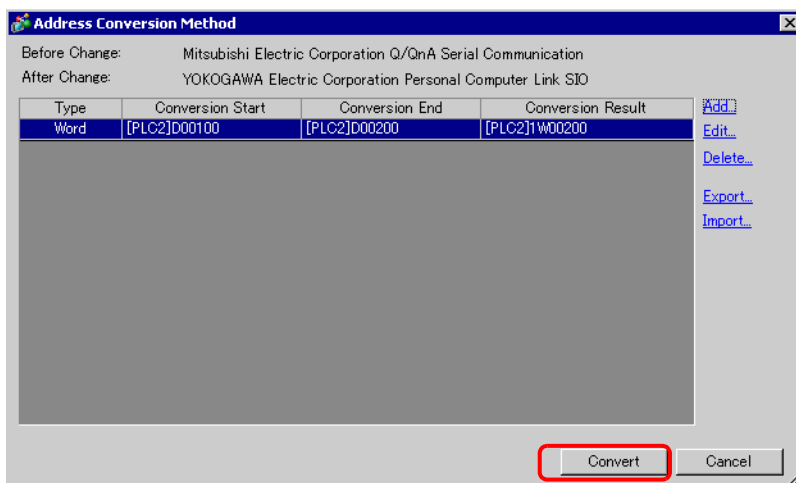
**NOTE**

- After converting a device/PLC, any parts, D-Scripts, Alarms, etc., must have their device addresses set again. Also, please save any screens that use a Special Switch set to [Screen Change].
- If using an Ethernet communication driver when converting multiple device/PLCs, [UDP] and [TCP] cannot be set up in the same driver. For example, when [Device/PLC 1] has been set to MELSEC A Ethernet [UDP] type, [Device/PLC 2] cannot be set to MELSEC A Ethernet [TCP] type.

7.5 Settings Guide

7.5.1 [Change Device/PLC] Settings Guide

In the [Device/PLC] page click [Change Device/PLC] and the following dialog box appears. Select the model of the Device/PLC you want to change.

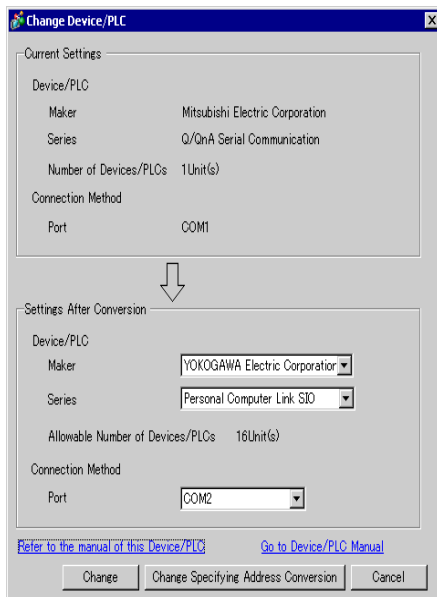

	Setting	Description
Current Settings	Maker	Displays the maker of the currently set device/PLC.
	Series	Displays the series of the currently set PLC.
	Number of Device/PLCs	Displays the number of connected devices for the currently set PLC.
	Port	Displays the connection port of the currently set device/PLC.
Settings after Conversion	Maker	Sets the maker of the new PLC.
	Series	Sets the series of the new PLC.
	Allowable Number of Devices/PLCs	Displays the number of devices that can be connected with the new PLC.
	Port	Select a connection port for the new PLC from [COM1], [COM2], [Ethernet (UDP)], or [Ethernet (TCP)].
	Refer to the manual of this Device/PLC	Displays the page for a changed device/PLC in the "GP-Pro EX Device/PLC Manual".
	Go to Device/PLC Manual	Displays the top page of the "GP-Pro EX Device/PLC Manual".

Continued

Change	Changes the model of device without specifying an address conversion pattern. NOTE <ul style="list-style-type: none"> Because no address conversion pattern is specified, if there is no destination address code, the address may not display correctly.
Change Specifying Address Conversion	Changes the model of device by specifying an address conversion pattern. Designate the previous address range and the top address of the destination device/PLC.
Cancel	Cancels the settings of the new device/PLC.

7.5.2 [Address Conversion Method Specification] Settings Guide

On the [Change Device/PLC] dialog box, click [Change Specifying Address Conversion] and the following dialog box appears. You can specify an Address Conversion Range when changing device/PLC models.

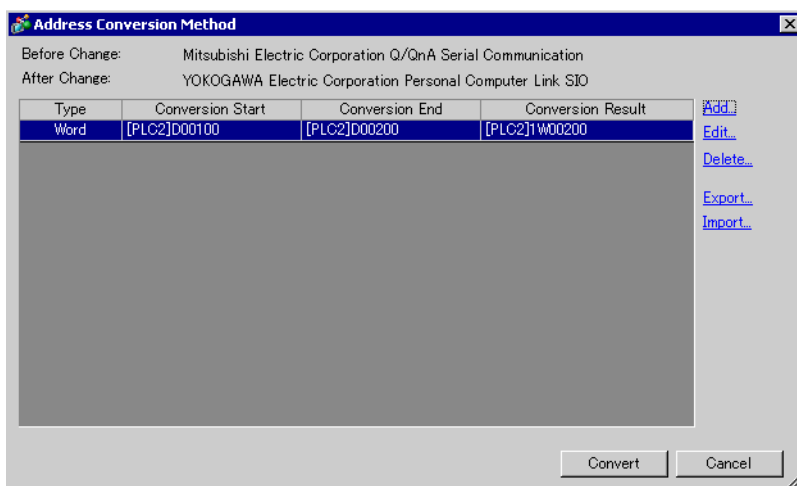

Setting	Description
Before Change	Displays the maker and series of the old PLC.
After Change	Displays the maker and series of the new PLC.
Type	Displays [Word] or [Bit], depending on which is the conversion address type.
Start Before Conversion	Displays the start value of the device address used before the address conversion.
End Before Conversion	Displays the end value of the device address used before the address conversion.
Start After Conversion	Displays the start value of the device address used after the address conversion.

Continued

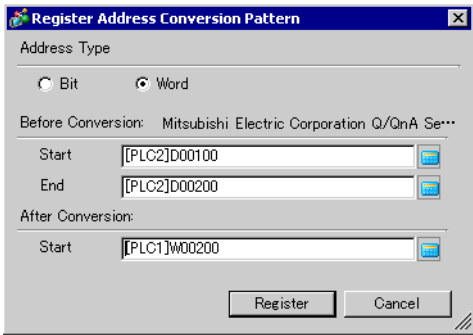
Setting	Description
Add/Edit	<p>Add/edit new settings for an address conversion pattern. The following dialog box appears.</p> 
Address Type	Choose conversion address type from [Bit] or [Word].
Before Conversion	Displays the maker and series of the old PLC.
Start	Set the source PLC and the start address.
End	Set the source PLC and the end address.
After Conversion	Displays the maker and series of the new PLC.
Start	Set the destination PLC and the start address.
Delete	Delete the address conversion pattern.

Continued

Setting	Description
Export/Import	<p data-bbox="305 170 1214 241">Read (Import) or output (Export) the contents of an Address Conversion Pattern.</p> <div data-bbox="408 285 1111 492" style="text-align: center;"> </div> <p data-bbox="340 531 459 569">(1) Import</p> <p data-bbox="340 569 1214 666">You can use a previously saved file in CSV format to create an address conversion pattern file (see (2)). Address conversion pattern files can be used in a different project by importing them.</p> <div data-bbox="411 705 1104 869" style="text-align: center;"> </div> <ul data-bbox="305 898 1214 975" style="list-style-type: none"> • Click on [Import] and the following [Open File] dialog box appears. Select the location and file name, click [Open] and the file will be imported. <div data-bbox="408 994 1008 1362" style="text-align: center;"> </div> <p data-bbox="315 1400 404 1439">NOTE</p> <ul data-bbox="305 1449 1214 1555" style="list-style-type: none"> • When importing a CSV file, make sure it matches the address conversion pattern format. If the formats do not match, the file will not be successfully imported.

Continued

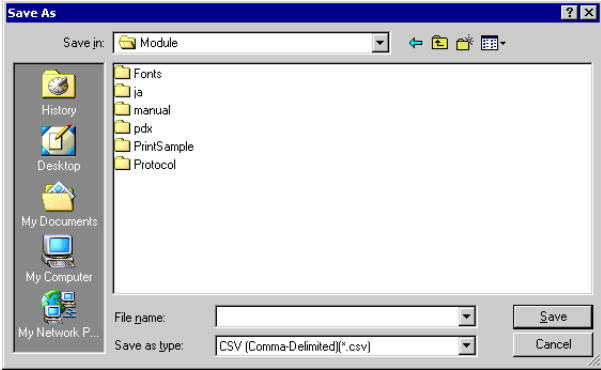
Setting	Description												
Export/Import	<p>(2) Export</p> <p>You can export registered address conversion patterns to other applications by saving them in CSV format. The saved file can then be edited in Microsoft Excel or other spreadsheet software.</p> <div style="text-align: center;"> <table border="1" style="display: inline-table; margin-right: 10px;"> <thead> <tr> <th>Top Before Conversion</th> <th>End Before Conversion</th> <th>Top After Conversion</th> </tr> </thead> <tbody> <tr> <td>D100</td> <td>D200</td> <td>W100</td> </tr> <tr> <td>D300</td> <td>D400</td> <td>W300</td> </tr> <tr> <td>⋮</td> <td>⋮</td> <td>⋮</td> </tr> </tbody> </table> ➔ <div style="display: inline-block; border: 1px solid black; padding: 5px; margin: 0 10px;">CSV format</div> ➔ <div style="display: inline-block; border: 1px solid black; padding: 5px; margin: 0 10px;">F.D.</div> ➔ <div style="display: inline-block; vertical-align: middle;">Edit in Microsoft Excel or use in another system</div> </div> <ul style="list-style-type: none"> Click on [Export] and the following [Save As] dialog box appears. Select the location and file name, click [Save] and the file will be exported. <div style="text-align: center;">  </div> <p>NOTE</p> <ul style="list-style-type: none"> This setting can be used when there are multiple address conversion patterns. The exported CSV file can be edited in a spreadsheet program such as Microsoft Excel. 	Top Before Conversion	End Before Conversion	Top After Conversion	D100	D200	W100	D300	D400	W300	⋮	⋮	⋮
Top Before Conversion	End Before Conversion	Top After Conversion											
D100	D200	W100											
D300	D400	W300											
⋮	⋮	⋮											

Continued

Setting	Description																														
Export/Import	<ul style="list-style-type: none"> Sample Output to a CSV File <p>Export data's CSV format is displayed as follows.</p> <p>Address conversion patterns before export</p> <div data-bbox="422 299 1094 710" data-label="Image"> </div> <p>The CSV file created by exporting the above file</p> <p>Pattern List Key Name *1</p> <p>OMR_CSIO Convert-From driver</p> <p>MIT_ACPU Convert-To driver</p> <p>0,[PLC1]DM0200,[PLC1]DM0300,[PLC1]D0100</p> <p>[Type], [Device/PLC Name] Convert-From Start Address, [Device/PLC Name] Convert-From End Address, [Device/PLC Name] Convert-To Start Address *2</p> <p>0,[PLC1]DM0300,[PLC1]DM0400,[PLC1]D0200</p> <p>[Type] *2, [Device/PLC Name] Convert-From Start Address, [Device/PLC Name] Convert-From End Address, [Device/PLC Name] Convert-To Start Address</p> <p>1,[PLC1]TIM0100,[PLC1]TIM0300,[PLC1]TS0200</p> <p>[Type] *2, [Device/PLC Name] Convert-From Start Address, [Device/PLC Name] Convert-From End Address, [Device/PLC Name] Convert-To Start Address</p> <p>When the above CSV file is represented in tabular format, it looks as follows.</p> <div data-bbox="326 1342 1190 1638" data-label="Table"> <table border="1"> <tr> <td>Pattern List</td> <td></td> <td></td> <td></td> <td></td> </tr> <tr> <td>OMR_CSIO</td> <td></td> <td></td> <td></td> <td></td> </tr> <tr> <td>MIT_ACPU</td> <td></td> <td></td> <td></td> <td></td> </tr> <tr> <td></td> <td>0</td> <td>[PLC1]DM0200</td> <td>[PLC1]DM0300</td> <td>[PLC1]D0100</td> </tr> <tr> <td></td> <td>0</td> <td>[PLC1]DM0300</td> <td>[PLC1]DM0400</td> <td>[PLC1]D0200</td> </tr> <tr> <td></td> <td>1</td> <td>[PLC1]TIM0100</td> <td>[PLC1]TIM0300</td> <td>[PLC1]TS0200</td> </tr> </table> <p>Annotations for the table above:</p> <ul style="list-style-type: none"> Convert-From driver (points to OMR_CSIO) Convert-To driver (points to MIT_ACPU) Type (points to the first column) Device/PLC Name (points to the second column) Convert-From Top Address (points to the third column) Convert-From End Address (points to the fourth column) Convert-To Top Address (points to the fifth column) </div>	Pattern List					OMR_CSIO					MIT_ACPU						0	[PLC1]DM0200	[PLC1]DM0300	[PLC1]D0100		0	[PLC1]DM0300	[PLC1]DM0400	[PLC1]D0200		1	[PLC1]TIM0100	[PLC1]TIM0300	[PLC1]TS0200
Pattern List																															
OMR_CSIO																															
MIT_ACPU																															
	0	[PLC1]DM0200	[PLC1]DM0300	[PLC1]D0100																											
	0	[PLC1]DM0300	[PLC1]DM0400	[PLC1]D0200																											
	1	[PLC1]TIM0100	[PLC1]TIM0300	[PLC1]TS0200																											

7.6 Restrictions

- After converting a device/PLC, any parts, D-Scripts, Alarms, etc., must have their device addresses set again. Also, please save any screens that use a Special Switch set to [Screen Change].
- If you change the device/PLC by clicking the [Change] button in the [Change Device/PLC] dialog box, the address conversion pattern may not display correctly if there is no device code at the destination. Confirm all device addresses used in the project and correct the relevant addresses.
- When using an Ethernet communication driver with multiple connections, [UDP] or [TCP] can not be set up in the same driver.

For example, when [Device/PLC1] has been set to MELSEC A Ethernet [UDP] type, [Device/PLC2] cannot be set to MELSEC A Ethernet [TCP] type.

- When deleting the settings for multiple connected PLCs, connected devices whose addresses are already used inside a project cannot be deleted. If you cannot delete PLC settings, click [Project] menu - [Utility] command and open [Cross Reference]. You can then check which addresses are being used. Delete the PLC settings after either replacing the address in use or deleting the unused address.
- You cannot stop the communication scan of a device specified with the System Area Start Address. However, if you are not using the System Data Area, you can stop the communication scan.

 “5.14.6 [System Settings] Setting Guide ◆ System Area Settings” (page 5-135)