



UNISEQUE Series Ethernet Driver

1	System Configuration.....	3
2	Selection of External Device	5
3	Example of Communication Setting.....	6
4	Setup Items.....	10
5	Supported Device.....	14
6	Device Code and Address Code.....	15
7	Error Messages.....	16

PREFACE

This manual describes how to connect the Display and the External Device (target PLC).

In this manual, the connection procedure will be described by following the below sections:

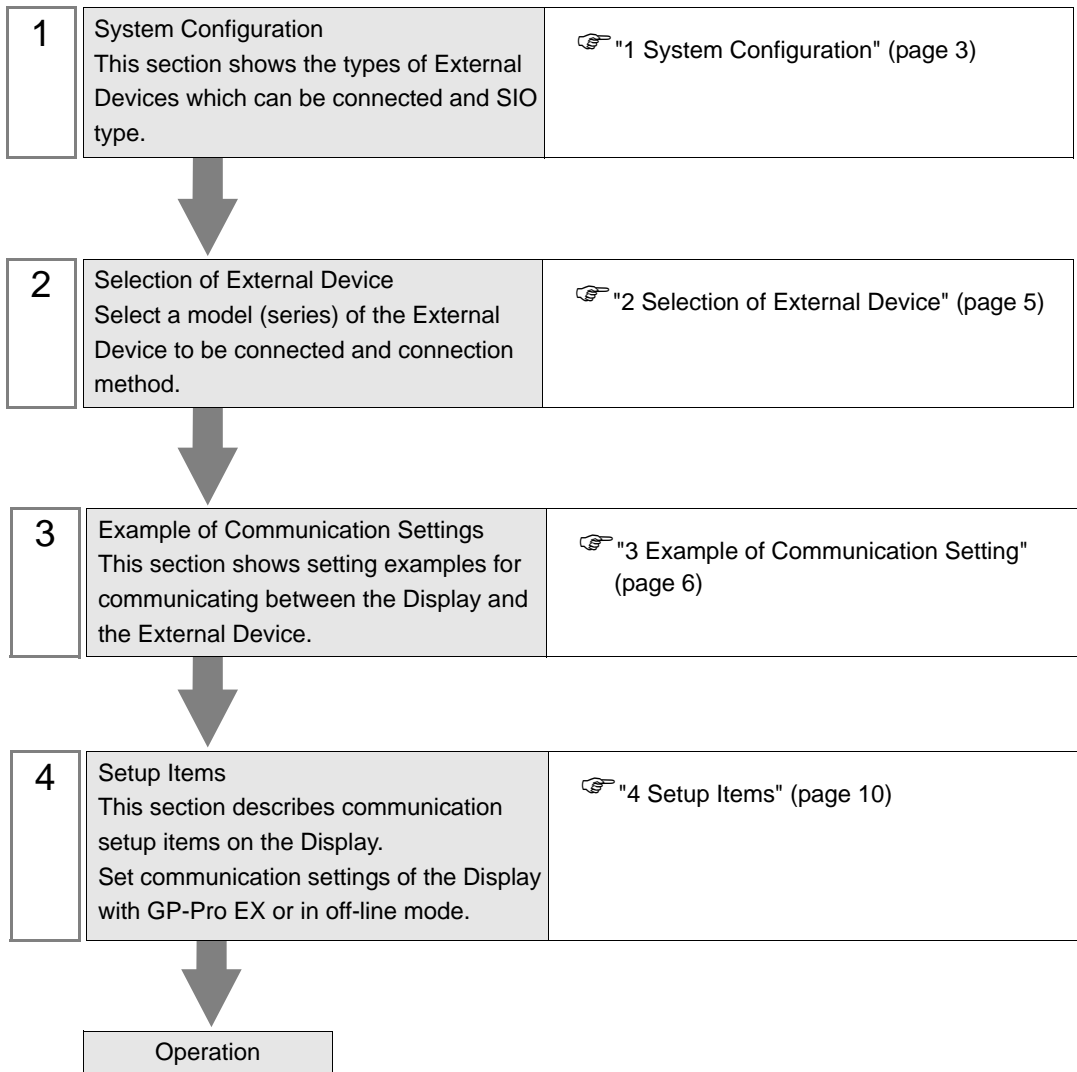

1 System Configuration

The system configuration in the case when the External Device of Meidensha Corporation and the Display are connected is shown.

Series Name	CPU	Link I/F	SIO Type	Setting Example
UNISEQUE	RC100	RM105	Ethernet	Setting Example 1 (page 6)
	RC500 ADC5000 P4000	PM404		Setting Example 2 (page 7)
	ADC4000 ADC7000	AM417		Setting Example 3 (page 9)

■ Connection Configuration

[1:1 Connection]

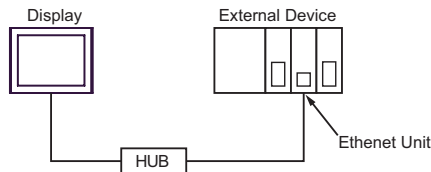

[Duplex System Connection]

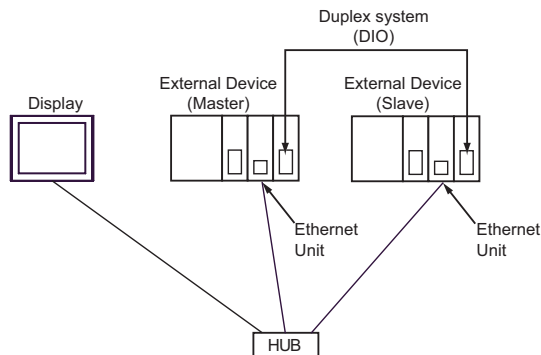

NOTE

- If the master and slave of the External Device are switched, the Display will automatically recognize the new specified master.

[1:n Connection]

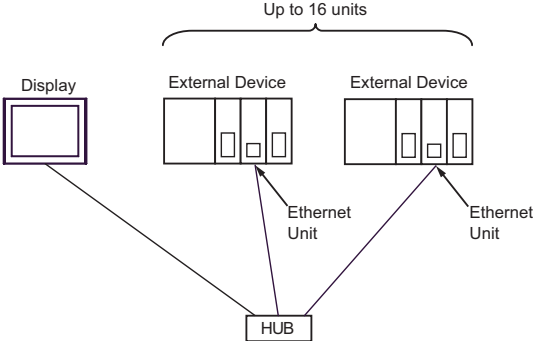

2 Selection of External Device

Select the External Device to be connected to the Display.

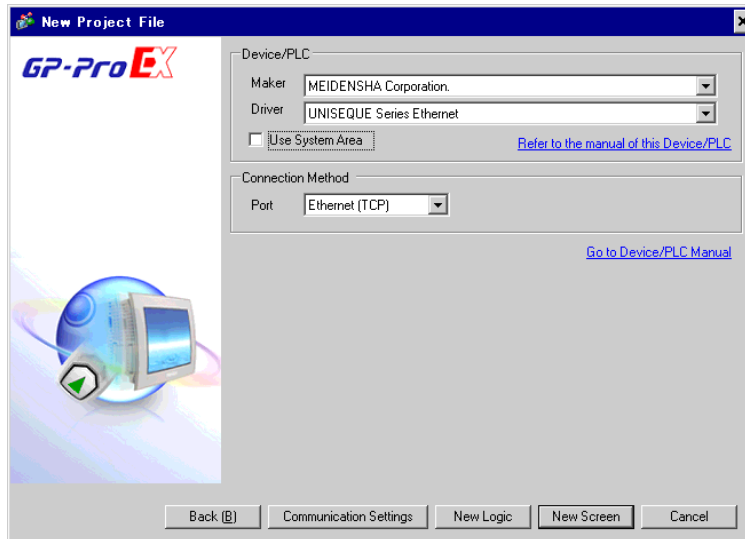

Setup Items	Setup Description
Maker	Select the maker of the External Device to be connected. Select "MEIDENSHA Corporation".
Driver	Select a model (series) of the External Device to be connected and connection method. Select "UNISEQUE Series Ethernet". Check the External Device which can be connected in "UNISEQUE Series Ethernet" in system configuration. ☞ "1 System Configuration" (page 3)
Use System Area	Check this option when you synchronize the system data area of the Display and the device (memory) of the External Device. When synchronized, you can use the ladder program of the External Device to switch the display or display the window on the Display. Cf. GP-Pro EX Reference Manual "Appendix 1.4 LS Area (only for direct access method)" This can be also set with GP-Pro EX or in off-line mode of the Display. Cf. GP-Pro EX Reference Manual " 5.14.6 Setting Guide of [System Setting Window]■[Main Unit Settings] Settings Guide◆System Area Setting" Cf. Maintenance/Troubleshooting "2.14.1 Settings common to all Display models ◆System Area Settings"
Port	Select the Display port to be connected to the External Device.

3 Example of Communication Setting

Examples of communication settings of the Display and the External Device, recommended by Digital Electronics Corp., are shown.

3.1 Setting Example 1

■ Settings of GP-Pro EX

◆ Communication Settings

To display the setting screen, select [Device/PLC Settings] from [System setting window] in workspace.

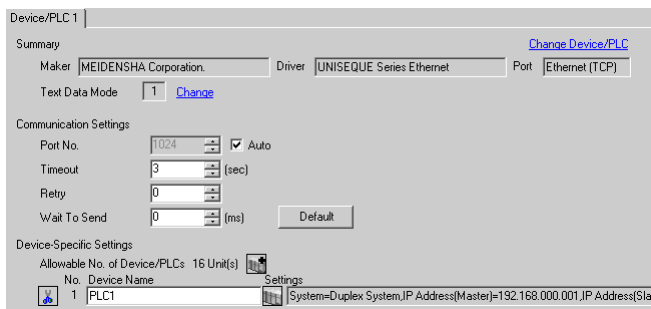

◆ Device Setting

To display the setting screen, click  ([Setting]) of the External Device you want to set from [Device-Specific Settings] of [Device/PLC Settings].

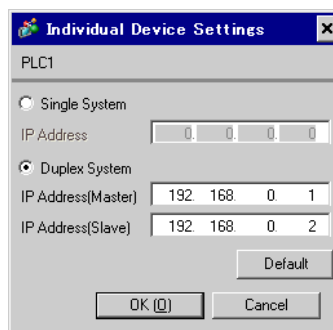

◆ Settings of External Device

Use the ladder software (Wp1000 for Win32) for communication settings of the External Device. Please refer to the manual of the External Device for more details.

1. Start up the ladder software.
2. Press [Shift] and [F4] keys to switch to the [Ethernet Setting] screen.
3. Press [Shift] and [F2] keys to switch to the [Program Reception] screen.
Press the [F8] key to read the communication settings from the External Device. Then, press [Shift] and [ESC] keys to return to the [Ethernet Setting] screen.
4. Press [Shift] and [F1] keys to switch to the [Browse/Change SourceIP Address] screen.
Enter the IP address to set in the [Change] field, and press the [F8]key to complete the setting.
5. Turn ON the power of the External Device again.

3.2 Setting Example 2

■ Settings of GP-Pro EX

◆ Communication Settings

To display the setting screen, select [Device/PLC Settings] from [System setting window] in workspace.

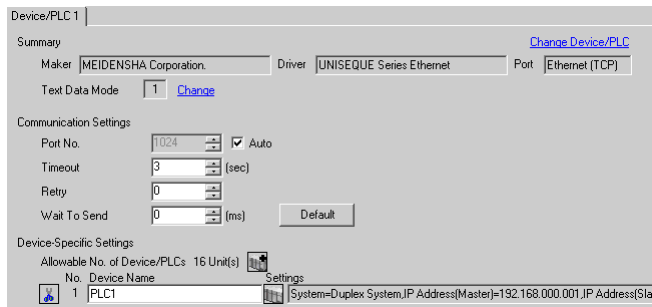

◆ Device Setting

To display the setting screen, click  ([Setting]) of the External Device you want to set from [Device-Specific Settings] of [Device/PLC Settings].

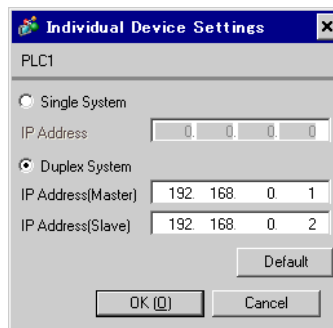

◆ Settings of External Device

Use the ladder software (Wp5000 for Win32) for communication settings of the External Device.

In the duplex system, the initial settings of IP address are as follows:

Initial master: 192.168.3.1

Initial slave: 192.168.3.2

Subnet mask: 255.255.255.0

Default gateway: 0.0.0.0

If you run the all memory clear, the IP address will return to the default setting.

Please refer to the manual of the External Device for more details.

1. Use the DIP switch to set the duplex system.

The DIP switch is located on the side of the base module attached.

Ethernet Module

DIP Switch	Setting Value	Description
7	ON	System selection in the duplex system When using the duplex system Initial master: ON Initial slave: OFF When using the single system: OFF

CPU Module

DIP Switch	Setting Value	Description
4	ON	When using the duplex system: ON When using the single system: OFF

2. Start up the ladder software.
3. Create the system definition file.
Enter the system definition file name in [File], and select [Save] from [Function], then click [OK].
4. Select [Specify Connecting PC] from the [File] menu, and set the External Device to use.
5. Select [ETHERNET Setting] from the [Main Function] menu, and set the IP address to transfer the communication settings to the External Device.
Double-click the node to which the EtherNet module is connected to display the dialog box. In that box, enter the IP address and node type.
After entry, click [OK] and finish [ETHERNET Setting].
6. Select [Configuration] from the [Main Function], and set the basic configuration.
Double-click the slot number to which the EtherNet module and the duplex I/F are connected, and register each module.
7. Select [File Definition] from the [Main Function] menu, and create the definition file of the EtherNet module.
Double-click the EtherNet module to display the [File Setting Details] dialog box. Click [File Call] in that box.
8. Select [Source IP Address Settings] from the [Main Function] menu, and enter the IP address.
If you press the space key when the cursor points the IP address, the entry box will be displayed.
After entering the IP address, subnet mask and default GW address, click [Transfer] to transfer the setting contents to the External Device.
9. After transfer, turn ON the power of the External Device again.

3.3 Setting Example 3

■ Settings of GP-Pro EX

◆ Communication Settings

To display the setting screen, select [Device/PLC Settings] from [System setting window] in workspace.

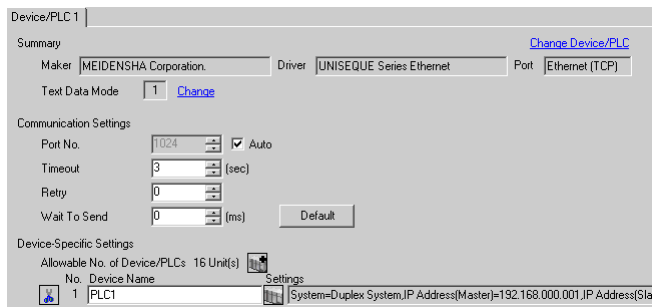

◆ Device Setting

To display the setting screen, click  ([Setting]) of the External Device you want to set from [Device-Specific Settings] of [Device/PLC Settings].

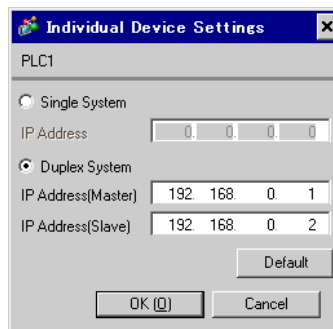

◆ Settings of External Device

Use the ladder software for communication setting of the External Device.

Please refer to the manual of the External Device for more details.

1. Start up the ladder software and perform the following communication settings.

Setup Items	Setting Value
IP Address	IP Address of Master PLC
IP Address	IP Address of Slave PLC ^{*1}
Port No. TCP	20010 (fixed)
Broadcast	Available

*1 Only when using the duplex system

4 Setup Items

Set communication settings of the Display with GP-Pro Ex or in off-line mode of the Display.

The setting of each parameter must be identical to that of External Device.

☞ "3 Example of Communication Setting" (page 6)

4.1 Setup Items in GP-Pro EX

■ Communication Settings

To display the setting screen, select [Device/PLC Settings] from [System setting window] in workspace.

Setup Items	Setup Description
Port No.	Use an integer from 1024 to 65535 to enter the port No. of the Display. When you check the option of [Auto], the port No. will be automatically set.
Timeout	Use an integer from 1 to 127 to enter the time (s) for which the Display waits for the response from the External Device.
Retry	In case of no response from the External Device, use an integer from 0 to 255 to enter how many times the Display retransmits the command.
Wait To Send	Use an integer from 0 to 255 to enter standby time (ms) for the Display from receiving packets to transmitting next commands.

■ Device Setting

To display the setting screen, click  ([Setting]) of the External Device you want to set from [Device-Specific Settings] of [Device/PLC Settings].

When connecting multiple External Devices, you can click  from [Device-Specific Settings] of [Device/PLC Settings] to add the External Device which is available to set.

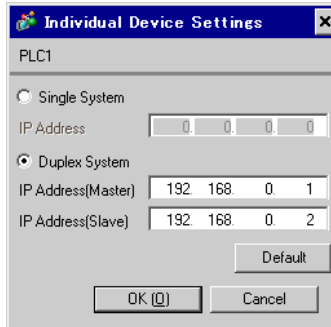

Setup Items	Setup Description
Single System	Select this option when the External device has the single system, and set the IP address.
Duplex System	Select this option when the External device has the duplex system, and set the IP addresses on the master and slave sides.

4.2 Settings in Off-Line Mode

NOTE

- Please refer to Maintenance/Troubleshooting for more information on how to enter off-line mode or about operation.

Cf. Maintenance/Troubleshooting "2.2 Offline Mode"

■ Communication Settings

To display the setting screen, touch [Device/PLC Settings] from [Peripheral Equipment Settings] in the off-line mode. Touch the External Device you want to set from the displayed list.

Comm.	Device			
UNISEQUE Series Ethernet		[TCP]		Page 1/1
Port No.	<input type="radio"/> Fixed <input checked="" type="radio"/> Auto	<input type="text" value="1024"/> ▼ ▲		
Timeout(s)		<input type="text" value="3"/> ▼ ▲		
Retry		<input type="text" value="0"/> ▼ ▲		
Wait To Send(ms)		<input type="text" value="0"/> ▼ ▲		
Exit		Back		2006/08/30 14:01:23

Setup Items	Setup Description
Port No.	Set the Port No. of the Display. Select either [Fixed] or [Auto]. When you select [Fixed], use an integer from 1024 to 65535 to enter the port No. of the Display. When you select [Auto], the port No. will be automatically assigned regardless of the entered value.
Timeout	Use an integer from 1 to 127 to enter the time (s) for which the Display waits for the response from the External Device.
Retry	In case of no response from the External Device, use an integer from 0 to 255 to enter how many times the Display retransmits the command.
Wait To Send	Use an integer from 0 to 255 to enter standby time (ms) for the Display from receiving packets to transmitting next commands.

■ Device Setting

To display the setting screen, touch [Device/PLC Settings] from [Peripheral Equipment Settings]. Touch the External Device you want to set from the displayed list, and touch [Device Settings].



Comm.	Device			
UNISEQUE Series Ethernet [TOP] Page 1/1				
Device/PLC Name		PLC1		
<input type="radio"/> Single <input checked="" type="radio"/> Duplex				
IP Address(Master)		192 168 0 1		
IP Address(Slave)		192 168 0 2		
Exit		Back		2006/08/30 14:01:29

Setup Items	Setup Description
Single	Select this option when the External Device has the single system.
Duplex	Select this option when the External Device has the duplex system.
IP Address (Master)	Enter the IP address set on the master side of the single or duplex system.
IP Address (Slave)	Enter the IP address set on the slave side of the duplex system. When the single system is selected, the entered IP address is invalid.

5 Supported Device

Range of supported device address is shown in the table below.

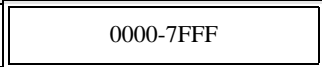
 This address can be specified as system data area.

Device	Bit Address	Word Address	32 bits	Remarks
Memory	0000.0-7FFF.F	 0000-7FFF		

NOTE

- Please refer to the GP-Pro EX Reference Manual for system data area.
Cf. GP-Pro EX Reference Manual "Appendix 1.4 LS Area (only for direct access method)"
- Please refer to the precautions on manual notation for icons in the table.
 "Manual Symbols and Terminology"

6 Device Code and Address Code

Use device code and address code when you select "Device Type & Address" for the address type in data displays.

Device	Device Name	Device Code (HEX)	Address Code
Memory	-	0080	Word Address

7 Error Messages

Error messages are displayed on the Display screen as follows: "No. : Device Name: Error Message(Error Occurrence Area)". Each description is shown below.

Item	Description
No.	Error No.
Device Name	Name of the External Device where error occurs. Device name is a title of the External Device set with GP-Pro EX.(Initial value[PLC1])
Error Message	Displays messages related to the error which occurs.
Error Occurrence Area	<p>Displays IP address or device address of the External Device where error occurs, or error codes received from the External Device.</p> <p>NOTE</p> <ul style="list-style-type: none"> • IP address is displayed such as "IP address(Decimal):MAC address (Hex)". • Device address is displayed such as "Address: Device address". • Received error codes are displayed such as "Decimal[Hex]".

Display Examples of Error Messages

"RHAA035: PLC1: Error has been responded for device write command (Error Code: 2[02H])"

NOTE

- Please refer to the manual of the External Device for more detail of received error codes.
- Please refer to "When an error message is displayed (Error Code List)" in "Maintenance/Troubleshooting manual" for more detail of the error messages common to the driver.