



Q Series CPU Direct Driver

1	System Configuration.....	3
2	External Devices Selection	8
3	Communication Settings	9
4	Setup Items	11
5	Cable Diagram	16
6	Supported Device.....	18
7	Device Code and Address Code.....	28
8	Error Messages	33

Introduction

This manual describes how to connect the Display and the External Device (target PLC).

In this manual, the connection procedure is described in the sections identified below:

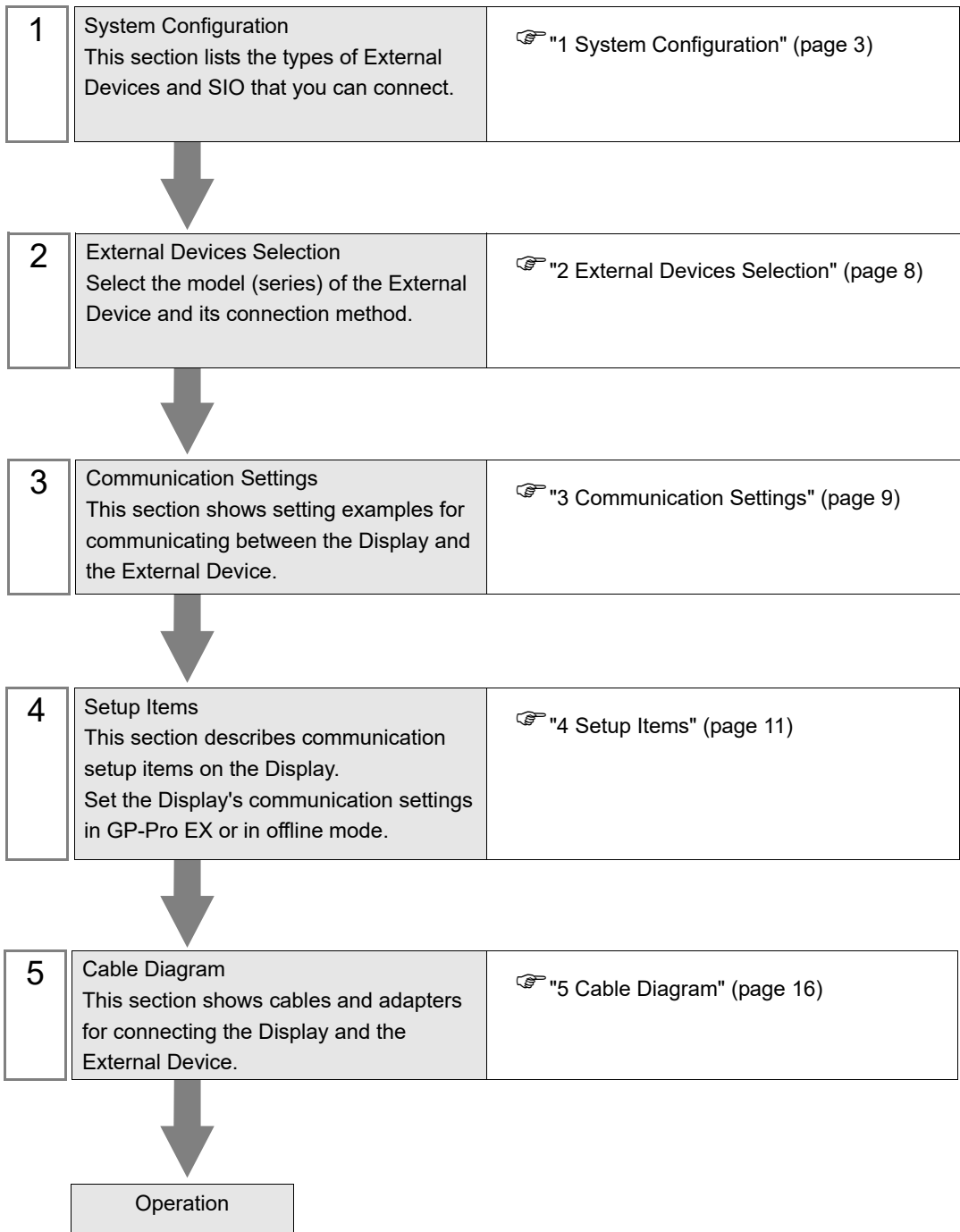

1 System Configuration

The system configuration in the case when the External Device and the Display are connected is shown.

Series	CPU	Link I/F	SIO Type	Setting Example	Cable Diagram
MELSEC Q Series	Q02CPU Q02HCPU Q06HCPU Q12HCPU Q25HCPU	RS-232C port on CPU unit	RS232C	Setting Example 1 (page 9)	Cable Diagram 1 (page 16)
	Q00UJCPU Q00UCPU Q01UCPU Q02UCPU Q03UDCPU Q04UDHCPU Q06UDHCPU Q10UDHCPU Q13UDHCPU Q20UDHCPU Q26UDHCPU				
	Q03UDEHCPU Q04UDEHCPU Q06UDEHCPU Q10UDEHCPU Q13UDEHCPU Q20UDEHCPU Q26UDEHCPU Q03UDVCPU Q04UDVCPU Q06UDVCPU Q13UDVCPU Q26UDVCPU	RS-232C port on High Performance Model QCPU or Universal Model QCPU *1*2			
	Q172HCPU	RS-232C port on High Performance Model QCPU *3			
	Q172DCPU Q173DCPU	RS-232C port on Universal Model QCPU *1*3			

*1 Except Q00UJCPU, Q00UCPU and Q01UCPU.

*2 Since the Built-in Ethernet port QCPU cannot be directly connected to the Display, use it with a Multi CPU System.

*3 Since the motion CPU (Q172HCPU, Q172DCPU, Q173DCPU) cannot be directly connected to the Display, use it with a Multi CPU System.

■ Connection Configuration

- Single CPU System

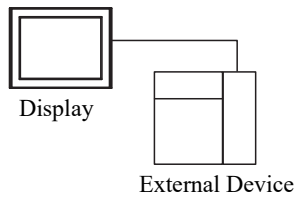

- Multi CPU System

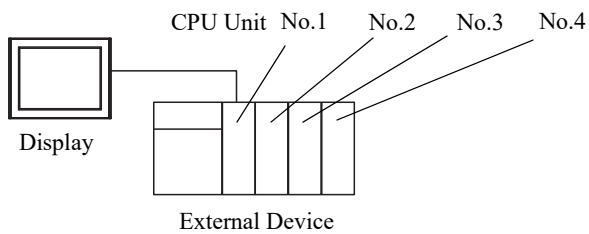

NOTE

- For CPU's Unit No., No.1 is allocated to the CPU slot and No.2, 3, and 4 are allocated to the other slots from No.1 to right.
 - With Multi CPU System, it's possible to access a CPU unit that is not directly connected. Regarding the external devices that can be used for Multi CPU System, please refer to the manual of the External Device.
 - Use the motion CPU within the No. 2 to No. 4 range. The motion CPU cannot be used as No. 1.
-

■ IPC COM Port

When connecting IPC with an External Device, the COM port used depends on the series and SIO type. Please refer to the IPC manual for details.

Usable port

Series	Usable Port		
	RS-232C	RS-422/485(4 wire)	RS-422/485(2 wire)
PS-2000B	COM1 ^{*1} , COM2, COM3 ^{*1} , COM4	-	-
PS-3450A, PS-3451A, PS3000-BA, PS3001-BD	COM1, COM2 ^{*1*2}	COM2 ^{*1*2}	COM2 ^{*1*2}
PS-3650A (T41 model), PS-3651A (T41 model)	COM1 ^{*1}	-	-
PS-3650A (T42 model), PS-3651A (T42 model)	COM1 ^{*1*2} , COM2	COM1 ^{*1*2}	COM1 ^{*1*2}
PS-3700A (Pentium®4-M) PS-3710A	COM1 ^{*1} , COM2 ^{*1} , COM3 ^{*2} , COM4	COM3 ^{*2}	COM3 ^{*2}
PS-3711A	COM1 ^{*1} , COM2 ^{*2}	COM2 ^{*2}	COM2 ^{*2}
PS4000 ^{*3}	COM1, COM2	-	-
PL3000	COM1 ^{*1*2} , COM2 ^{*1} , COM3, COM4	COM1 ^{*1*2}	COM1 ^{*1*2}
PE-4000B Atom N270	COM1, COM2	-	-
PE-4000B Atom N2600	COM1, COM2	COM3 ^{*4} , COM4 ^{*4} , COM5 ^{*4} , COM6 ^{*4}	COM3 ^{*4} , COM4 ^{*4} , COM5 ^{*4} , COM6 ^{*4}
PS5000 (Slim Panel Type Core i3 Model) ^{*5*6}	COM1, COM2 ^{*4}	COM2 ^{*4}	COM2 ^{*4}
PS5000 (Slim Panel Type Atom Model) ^{*5*6}	COM1, COM2 ^{*7}	COM2 ^{*7}	COM2 ^{*7}
PS5000 (Enclosed Panel Type) ^{*8}	COM1	-	-
PS5000 (Modular Type PFXPU/PFXPP) ^{*5*6} PS5000 (Modular Type PFXPL2B5-6)	COM1 ^{*7}	COM1 ^{*7}	COM1 ^{*7}
PS5000 (Modular Type PFXPL2B1-4)	COM1, COM2 ^{*7}	COM2 ^{*7}	COM2 ^{*7}
PS6000 (Advanced Box) PS6000 (Standard Box)	COM1 ^{*9}	*10	*10
PS6000 (Basic Box)	COM1 ^{*9}	COM1 ^{*9}	COM1 ^{*9}

*1 The RI/5V can be switched. Use the IPC's switch to change if necessary.

*2 Set up the SIO type with the DIP Switch. Please set up as follows according to SIO type to be used.

- *3 When making communication between an External Device and COM port on the Expansion slot, only RS-232C is supported. However, ER (DTR/CTS) control cannot be executed because of the specification of COM port.
For connection with External Device, use user-created cables and disable Pin Nos. 1, 4, 6 and 9. Please refer to the IPC manual for details of pin layout.
- *4 Set up the SIO type with the BIOS. Please refer to the IPC manual for details of BIOS.
- *5 When setting up communication between an External Device and the RS-232C/422/485 interface module, use the IPC (RS-232C) or PS5000 (RS-422/485) cable diagrams. However, when using PFXZPBMPR42P2 in a RS-422/485 (4-wire) configuration with no flow control, connect 7.RTS+ and 8.CTS+, and connect 6.RTS- and 9.CTS-.
When using RS-422/485 communication with External Devices, you may need to reduce the transmission speed and increase the TX Wait time.
- *6 To use RS-422/485 communication on the RS-232C/422/485 interface module, the DIP Switch setting is required. Please refer to "Knowledge Base" (FAQs) on the support site. (<http://www.pro-face.com/trans/en/manual/1001.html>)

Settings	FAQ ID
PFXZPBMPR42P2, RS422/485 change method	FA263858
PFXZPBMPR42P2 termination resistor setting	FA263974
PFXZPBMPR44P2, RS422/485 change method	FA264087
PFXZPBMPR44P2 termination resistor setting	FA264088

- *7 Set up the SIO type with the DIP Switch. Please refer to the IPC manual for details of DIP Switch. The BOX Atom has not a switch to set the RS-232C, RS-422/485 mode. Use the BIOS for the setting.
- *8 For the connection with the External Device, on the user-created cable read as if the connector on the Display-side is a M12 A-coding 8 pin socket. The pin assignment is the same as described in the cable diagram. For the M12 A-coding connector, use PFXZPSCNM122.
- *9 In addition to COM1, you can also use the COM port on the optional interface.
- *10 Install the optional interface in the expansion slot.

DIP Switch settings (PL3000 / PS3000 Series)

RS-232C

DIP Switch	Setting	Description
1	OFF*1	Reserved (always OFF)
2	OFF	SIO type: RS-232C
3	OFF	
4	OFF	Output mode of SD (TXD) data: Always output
5	OFF	Terminal resistance (220Ω) insertion to SD (TXD): None
6	OFF	Terminal resistance (220Ω) insertion to RD (RXD): None
7	OFF	Short-circuit of SDA (TXA) and RDA (RXA): Not available
8	OFF	Short-circuit of SDB (TXB) and RDB (RXB): Not available
9	OFF	RS (RTS) Auto control mode: Disabled
10	OFF	

*1 When using PS-3450A, PS-3451A, PS3000-BA and PS3001-BD, turn ON the set value.

RS-422/485 (4 wire)

DIP Switch	Setting	Description
1	OFF	Reserved (always OFF)
2	ON	SIO type: RS-422/485
3	ON	
4	OFF	Output mode of SD (TXD) data: Always output
5	OFF	Terminal resistance (220Ω) insertion to SD (TXD): None
6	OFF	Terminal resistance (220Ω) insertion to RD (RXD): None
7	OFF	Short-circuit of SDA (TXA) and RDA (RXA): Not available
8	OFF	Short-circuit of SDB (TXB) and RDB (RXB): Not available
9	OFF	RS (RTS) Auto control mode: Disabled
10	OFF	

RS-422/485 (2 wire)

DIP Switch	Setting	Description
1	OFF	Reserved (always OFF)
2	ON	SIO type: RS-422/485
3	ON	
4	OFF	Output mode of SD (TXD) data: Always output
5	OFF	Terminal resistance (220Ω) insertion to SD (TXD): None
6	OFF	Terminal resistance (220Ω) insertion to RD (RXD): None
7	ON	Short-circuit of SDA (TXA) and RDA (RXA): Available
8	ON	Short-circuit of SDB (TXB) and RDB (RXB): Available
9	ON	RS (RTS) Auto control mode: Enabled
10	ON	

2 External Devices Selection

Select the External Device to be connected to the Display.

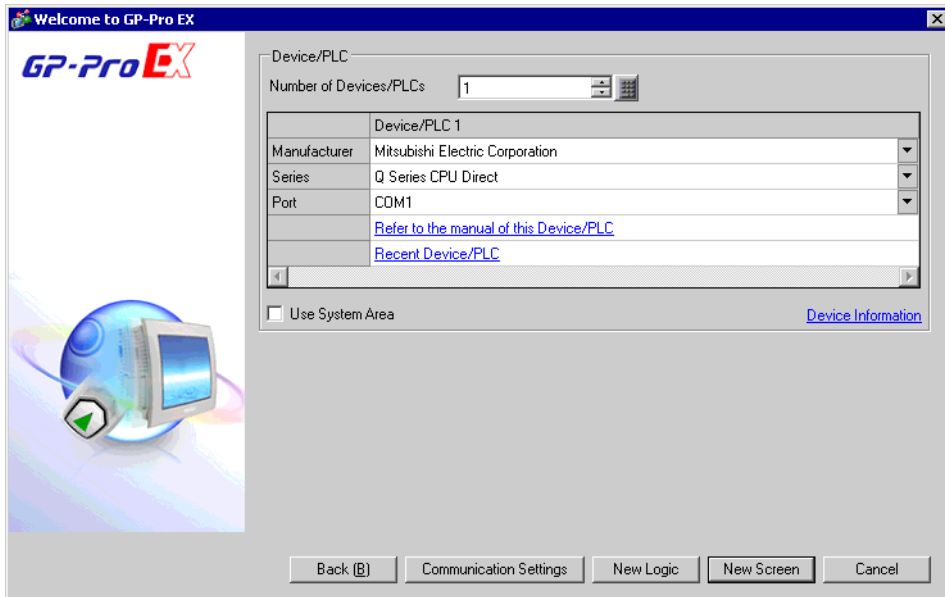

Setup Items	Setup Description
Number of Devices/PLCs	Enter an integer from 1 to 4 to define the number of Devices/PLCs to connect to the display.
Manufacturer	Select the manufacturer of the External Device to connect. Select "Mitsubishi Electric Corporation".
Series	Select the External Device model (series) and the connection method. Select "Q Series CPU Direct". In System configuration, make sure the External Device you are connecting is supported by "Q Series CPU Direct". ☞ "1 System Configuration" (page 3)
Port	Select the Display port to connect to the External Device.
Use System Area	Check this option to synchronize the system data area of the Display and the device (memory) of the External Device. When synchronized, you can use the External Device's ladder program to switch the display or display the window on the Display. Cf. GP-Pro EX Reference Manual "LS Area (Direct Access Method Area)" This feature can also be set in GP-Pro EX or in the Display's offline mode. Cf. GP-Pro EX Reference Manual "System Settings [Display Unit] - [System Area] Settings Guide" Cf. Maintenance/Troubleshooting Guide "Main Unit - System Area Settings"

3 Communication Settings

Examples of communication settings of the Display and the External Device, recommended by Pro-face, are shown.

3.1 Setting Example 1

■ Settings of GP-Pro EX

◆ Communication Settings

To display the setup screen, from the [Project] menu, point to [System Settings] and select [Device/PLC].

Device/PLC 1

Summary [Change Device/PLC](#)

Manufacturer Series Port

Text Data Mode [Change](#)

Communication Settings

SID Type RS232C RS422/485(2wire) RS422/485(4wire)

Speed

Data Length 7 8

Parity NONE EVEN ODD

Stop Bit 1 2

Flow Control NONE ER(DTR/CTS) XON/XOFF

Timeout (sec)

Retry

Wait To Send (ms)

RI / VCC RI VCC

In the case of RS232C, you can select the 9th pin to RI (Input) or VCC (5V Power Supply). If you use the Digital's RS232C Isolation Unit, please select it to VCC.

Device-Specific Settings

Allowable Number of Devices/PLCs [Add Device](#)

No.	Device Name	Settings
<input type="button" value="↓"/> 1	<input type="text" value="PLC1"/>	<input type="button" value="⋮"/>

[Add Indirect Device](#)

◆ Device Setting

To display the [Individual Device Settings] dialog box, from [Device-Specific Settings] in the [Device/PLC] window, select the external device and click [Settings] .

Individual Device Settings

PLC1

Bit set in word address operation

Other bits in this word Clear Do not clear

Note on when selecting "Do not clear": If the ladder program writes data to the word address during the read/write process, the resulting data may be incorrect.

■ Settings of External Device

The speed automatically switches according to the Display setting.

When using Q00UJCPU, Q00UCPU, Q01UCPU, or Q02UCPU, in setting the PC Parameters, from the [Serial] area clear the [Use serial communication] check box. Communication is not possible when the check box is selected. After changing the settings restart the External Device. When using a CPU other than those above, there are no settings on the External Device.

4 Setup Items

Set communication settings of the Display with GP-Pro EX or in offline mode of the Display.

The setting of each parameter must be identical to that of External Device.

☞ "3 Communication Settings" (page 9)

4.1 Setup Items in GP-Pro EX

■ Communication Settings

To display the setup screen, from the [Project] menu, point to [System Settings] and select [Device/PLC].

Device/PLC 1

Summary [Change Device/PLC](#)

Manufacturer Series Port

Text Data Mode [Change](#)

Communication Settings

SIO Type RS232C RS422/485(2wire) RS422/485(4wire)

Speed

Data Length 7 8

Parity NONE EVEN ODD

Stop Bit 1 2

Flow Control NONE ER(DTR/CTS) XON/XOFF

Timeout (sec)

Retry

Wait To Send (ms)

RI / VCC RI VCC

In the case of RS232C, you can select the 9th pin to RI (Input) or VCC (5V Power Supply). If you use the Digital's RS232C Isolation Unit, please select it to VCC.

Device-Specific Settings

Allowable Number of Devices/PLCs [Add Device](#)

No.	Device Name	Settings
<input type="text" value="1"/>	<input type="text" value="PLC1"/>	<input type="text"/>

[Add Indirect Device](#)

Setup Items	Setup Description
SIO Type	Select the SIO type to communicate with the External Device.
Speed	Select speed between the External Device and the Display.
Data Length	Data length is displayed.
Parity	The parity check method is displayed.
Stop Bit	Stop bit length is displayed.
Flow Control	The communication control method to prevent overflow of transmission and reception data is displayed.
Timeout	Use an integer from 1 to 127 to enter the time (s) for which the Display waits for the response from the External Device.
Retry	In case of no response from the External Device, use an integer from 0 to 255 to enter how many times the Display retransmits the command.
Wait To Send	Use an integer from 0 to 255 to enter standby time (ms) for the Display from receiving packets to transmitting next commands.

Setup Items	Setup Description
RI/VCC	Switches RI/VCC of the 9th pin. It is necessary to change RI/5V by changeover switch of IPC when connect with IPC. Please refer to the manual of the IPC for more detail.

NOTE

- Refer to the GP-Pro EX Reference Manual for Indirect Device.
Cf. GP-Pro EX Reference Manual "Changing the Device/PLC at Runtime (Indirect Device)"

■ Device Setting

To display the [Individual Device Settings] dialog box, from [Device-Specific Settings] in the [Device/PLC] window, select the external device and click [Settings] .

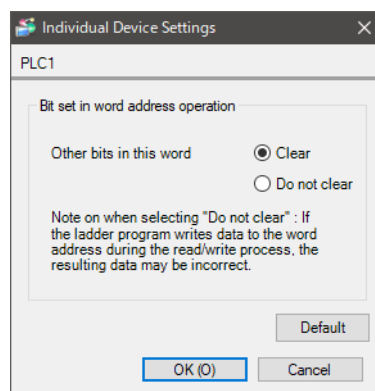

Setup Items	Setup Description
Other bits in this word	Select "Clear" or "Do not clear" for the handling of other bit data in the same word when a bit operation is performed to a bit specified word address.

4.2 Setup Items in OffLine Mode

- NOTE**
- Please refer to Maintenance/Troubleshooting Guide for more information on how to enter offline mode or about operation.
Cf. Maintenance/Troubleshooting Guide "Offline Mode"
 - The number of the setup items to be displayed for 1 page in the offline mode depends on the Display in use. Please refer to the Reference manual for details.

■ Communication Settings

To display the setting screen, touch [Device/PLC Settings] from [Peripheral Settings] in offline mode. Touch the External Device you want to set from the displayed list.

Comm.	Device	Option		
Q Series CPU Direct		[COM1]	Page 1/1	
SIO Type	RS232C			
Speed	19200			
Data Length	8			
Parity	ODD			
Stop Bit	1			
Flow Control	ER(DTR/CTS)			
Timeout(s)	3			
Retry	2			
Wait To Send(ms)	0			
Exit		Back		2022/12/02 14:35:20

Setup Items	Setup Description
SIO Type	<p>SIO type to communicate with the External Device is displayed.</p> <p>IMPORTANT</p> <p>To make the communication settings correctly, confirm the serial interface specifications of Display unit for [SIO Type]. We cannot guarantee the operation if a communication type that the serial interface does not support is specified. For details concerning the serial interface specifications, refer to the manual for Display unit.</p>
Speed	Select speed between the External Device and the Display.
Data Length	Data length is displayed.
Parity	The parity check method is displayed.
Stop Bit	Stop bit length is displayed.
Flow Control	The communication control method to prevent overflow of transmission and reception data is displayed.
Timeout	Use an integer from 1 to 127 to enter the time (s) for which the Display waits for the response from the External Device.

Setup Items	Setup Description
Retry	In case of no response from the External Device, use an integer from 0 to 255 to enter how many times the Display retransmits the command.
Wait To Send	Use an integer from 0 to 255 to enter standby time (ms) for the Display from receiving packets to transmitting next commands.

■ Device Setting

To display the setting screen, touch [Device/PLC Settings] from [Peripheral Settings]. Touch the External Device you want to set from the list that appears, and touch [Device].

Comm.	Device	Option		
Q Series CPU Direct		[COM1]	Page 1/1	
Device/PLC Name <input type="text" value="PLC1"/>				
Bit set in word address operation				
Other bits Clear				
		Exit	Back	2022/12/02 14:35:31

Setup Items	Setup Description
Device/PLC Name	Select the External Device to set. Device/PLC Name is the title of the External Device set with GP-Pro EX. (Initial value [PLC1])
Bit set in word address operation	Displays "Clear" or "Do not clear" for the handling of other bit data in the same word when a bit operation is performed to a bit specified word address. (Cannot be set in offline mode.)

■ Option

To display the setting screen, touch [Device/PLC Settings] from [Peripheral Settings]. Touch the External Device you want to set from the displayed list, and touch [Option].

Comm.	Device	Option		
Q Series CPU Direct		[COM1]	Page 1/1	
RI / VCC <input checked="" type="radio"/> RI <input type="radio"/> VCC In the case of RS232C, you can select the 9th pin to RI(Input) or VCC(5V Power Supply). If you use the Digital's RS232C Isolation Unit, please select it to VCC.				
		Exit	Back	2005/09/02 12:36:41

Setup Items	Setup Description
RI/VCC	Switches RI/VCC of the 9th pin. It is necessary to change RI/5V by changeover switch of IPC when connect with IPC. Please refer to the manual of the IPC for more detail.

NOTE

- GP-4100 series, GP-4*01TM and GP-Rear Module do not have the [Option] setting in the offline mode.

5 Cable Diagram

The following cable diagrams may be different from cable diagrams recommended by External Device Manufacturer.

Please be assured there is no operational problem in applying the cable diagram shown in this manual.

- The FG pin of the External Device body must be grounded according to your country's applicable standard. Refer to your External Device manual for details.
- SG and FG are connected inside the Display. When connecting the External Device to SG, design your system to avoid short-circuit loops.
- Connect an isolation unit if the communication is not stable due to noise or other factors.

5.1 Cable Diagram 1

Display (Connection Port)	Cable		Notes
GP3000 (COM1) GP4000* ¹ (COM1) SP5000* ² (COM1/2) SP-5B00 (COM1) ST3000 (COM1) ST6000 (COM1) STM6000 (COM1) STC6000 (COM1) ET6000 (COM1) LT3000 (COM1) IPC* ³ PC/AT	1A	Mitsubishi PLC Q-Series Connection Cable (5m) by Pro-face CA3-CBLQ-01 or RS-232C cable by Mitsubishi Electric Corp. QC30R2 (3m) or RS-232C cable for MELSEC-Q CPU connection by Diatrend Corp. DQCABR2V-H	Available to order the length of DQCABR2V-H by Diatrend Corp. up to 15m.
GP-4105 (COM1) GP-4115T (COM1) GP-4115T3 (COM1)	1B	Mitsubishi PLC Q-Series CPU I/F Cable (3m) by Pro-face ZC9CBQ31	

*1 All GP4000 models except GP-4100 series and GP-4203T

*2 Except SP-5B00

*3 Only the COM port which can communicate by RS-232C can be used.

- IPC COM Port (page 5)

1A)

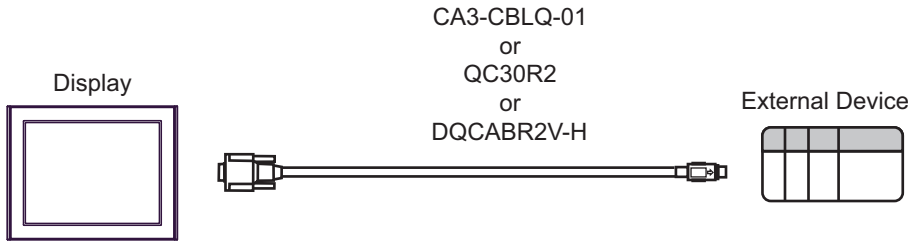

1B)

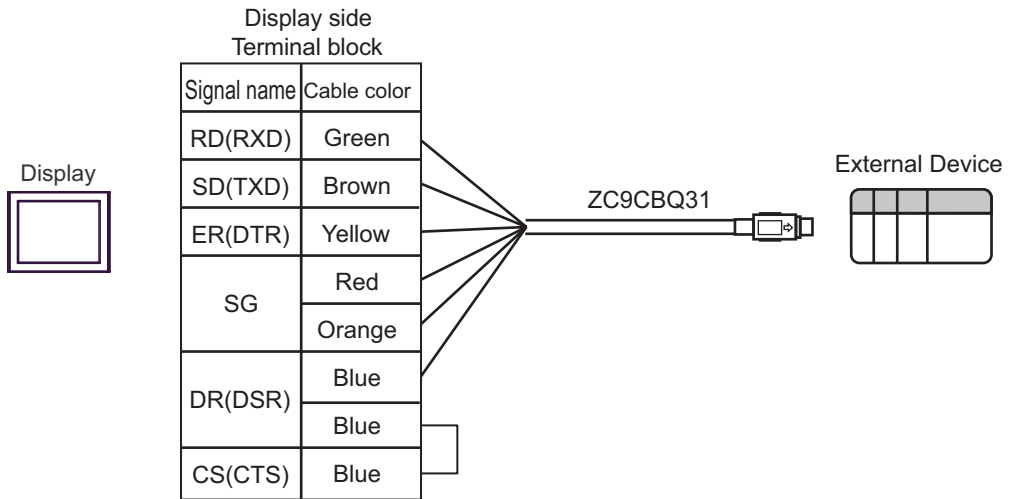

6 Supported Device

Range of supported device address is shown in the table below. Please note that the actually supported range of the devices varies depending on the External Device to be used. Please check the actual range in the manual of your External Device.

Input address of external device in the dialog below.

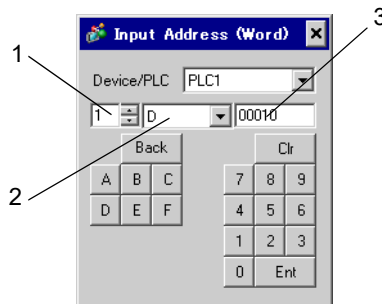











- | | |
|----------------|------------------------------------------------------------------------------------------------------------------------------------------------------------|
| 1. Unit Number | Select the number of a CPU unit to communicate with from 1 to 4.
Select "0" to access a CPU unit that is directly connected like the Single CPU System. |
| 2. Device | Specify a device. |
| 3. Address | Specify an address. |

6.1 MELSEC Q (High performance model) Series

 This address can be specified as system data area.

Device	Bit Address	Word Address	32 bits	Notes
Input Relay	X0000 - X1FFF	X0000 - X1FF0	L / H	***0
Output Relay	Y0000 - Y1FFF	Y0000 - Y1FF0		***0
Internal Relay	M00000 - M32767	M00000 - M32752		÷16
Special Relay	SM0000 - SM2047	SM0000 - SM2032		÷16
Latch Relay	L00000 - L32767	L00000 - L32752		÷16
Annunciator	F00000 - F32767	F00000 - F32752		÷16
Edge Relay	V00000 - V32767	V00000 - V32752		÷16
Step Relay	S0000 - S8191	S0000 - S8176		÷16
Link Relay	B0000 - B7FFF	B0000 - B7FF0		***0
Special Link Relay	SB000 - SB7FF	SB000 - SB7F0		***0
Timer (Contact)	TS00000 - TS23087	-----		
Timer (Coil)	TC00000 - TC23087	-----		
Retentive Timer (Contact)	SS00000 - SS23087	-----		
Retentive Timer (Coil)	SC00000 - SC23087	-----		

Device	Bit Address	Word Address	32 bits	Notes
Counter (Contact)	CS00000 - CS23087	-----	[L/H]	
Counter (Coil)	CC00000 - CC23087	-----		
Timer (Current Value)	-----	TN00000 - TN23087		
Retentive Timer (Current Value)	-----	SN00000 - SN23087		
Counter (Current Value)	-----	CN00000 - CN23087		
Data Register	-----	D00000 - D25983		 *1 *2
Special Register	-----	SD0000 - SD2047		 *2
Link Register	-----	W0000 - W657F		 *2
Special Link Register	-----	SW000 - SW7FF		 *2
File Register (Normal)	-----	R00000 - R32767		 *2
File Register (Block switching is not necessary)	-----	ZR0000000 - ZR1042431		 *2
File Register (0R-31R) ^{*3}	-----	0R00000 - 0R32767		 *2
	-----	1R00000 - 1R32767		 *2
	-----	2R00000 - 2R32767		 *2
	:	:	:	
	-----	30R00000 - 30R32767	 *2	
	-----	31R00000 - 31R26623	 *2	

*1 The setting of the Multi CPU System is possible also in the system data area.

*2 The access method when specifying bits is different depending on the setting of "Other bits in this word" in "Individual Device Settings".

[Clear] 

[Do not clear] When bits are written, the Display reads the corresponding word address from the External Device, sets particular bits of that word address to ON, and then returns the resulting address to the External Device. Note that the data may not be written correctly if you write to the word address using the ladder program while the Display is reading data from, and writing data to, the External Device.

*3 Set the block No. on the head of device name. This is the device name for conversion with GP-Pro/PB III for Windows. When you newly specify the device, we recommend that you should use the file register (Block switching is not necessary).

NOTE

- The notation of addresses differs depending on a selected Unit No.
<Ex.>When 0 is selected for Unit No.,

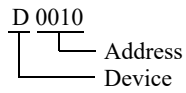



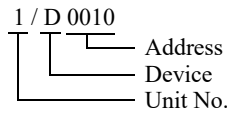









- <Ex.>When 1 is selected for Unit No.,





















- Please refer to the GP-Pro EX Reference Manual for system data area.
Cf. GP-Pro EX Reference Manual "LS Area (Direct Access Method Area)"
- Please refer to the precautions on manual notation for icons in the table.
☞ "Manual Symbols and Terminology"

6.2 MELSEC Q (Universal model) Series

 This address can be specified as system data area.

Device	Bit Address	Word Address	32 bits	Notes
Input Relay	X0000-X1FFF	X0000-X1FF0	L/H	
Output Relay	Y0000-Y1FFF	Y0000-Y1FF0		
Internal Relay	M00000-M32767	M00000-M32752		 *1
	M00000-M61439	M0000-M61424		 *2
Special Relay	SM0000-SM2047	SM0000-SM2032		
Latch Relay	L00000-L32767	L00000-L32752		
Annunciator	F00000-F32767	F00000-F32752		
Edge Relay	V00000-V32767	V00000-V32752		
Step Relay	S0000-S8191	S0000-S8176		
Link Relay	B0000-B7FFF	B0000-B7FF0		 *1
	B0000-BEFFF	B0000-BEFFF		 *2
Special Link Relay	SB0000-SB7FFF	SB0000-SB7FF0		
Timer (Contact)	TS00000-TS25023	-----		*1
	TS00000-TS25471	-----		*2
Timer (Coil)	TC00000-TC25023	-----		*1
	TC00000-TC25471	-----		*2
Retentive Timer (Contact)	SS00000-SS25023	-----		*1
	SS00000-SS25471	-----		*2
Retentive Timer (Coil)	SC00000-SC25023	-----		*1
	SC00000-SC25471	-----		*2
Counter (Contact)	CS00000-CS25023	-----	*1	
	CS00000-CS25471	-----	*2	
Counter (Coil)	CC00000-CC25023	-----	*1	
	CC00000-CC25471	-----	*2	
Timer (Current Value)	-----	TN00000-TN25023	*1	
	-----	TN00000-TN25471	*2	
Retentive Timer (Current Value)	-----	SN00000-SN25023	*1	
	-----	SN00000-SN25471	*2	

Device	Bit Address	Word Address	32 bits	Notes
Counter (Current Value)	-----	CN00000-CN25023	[L/H]	*1
	-----	CN00000-CN25471		*2
Data Register / External Data Register*3	-----	D0000000-D0028671		 *4 *5
		D0000000-D4910079		 *4 *5 *6 *11
		D0000000-D0094207		 *4 *5 *6 *7 *11
Special Register	-----	SD0000-SD2047		 *5
Link Register / External Link Register*8	-----	W000000-W006FFF		 *5
		W000000-W4AEBFF		 *5 *9 *11
		W000000-W016FFF		 *5 *7 *9 *11
Special Link Register	-----	SW0000-SW6DFE		 *1 *5
	-----	SW0000-SW6FFF		 *2 *5
Common device for Multiple CPU*10	-----	U3E0-10000 - U3E0-24335		 *5
	-----	U3E1-10000 - U3E1-24335		 *5
	-----	U3E2-10000 - U3E2-24335		 *5
	-----	U3E3-10000 - U3E3-24335		 *5
File Register (Normal)*11	-----	R00000-R32767		 *5
File Register (Block switching is not necessary)*11	-----	ZR0000000- ZR4849663		 *5
File Register (0R-31R)*11 *12	-----	0R00000-0R32767		[L/H]
	-----	1R00000-1R32767	 *5	
	-----	2R00000-2R32767	 *5	
	:	:	:	
	-----	30R00000-30R32767	 *5	
	-----	31R00000-31R32767	 *5	

*1 For the universal model QCPU with a serial number whose first 5 digits is less than "10042".

*2 For the universal model QCPU with a serial number whose first 5 digits is "10042" or more.

*3 External Data Register can be used in the CPU of which first 5 digits of serial No. is 09042 or later.

- *4 The setting of the Multi CPU System is possible also in the system data area.
- *5 The access method when specifying bits is different depending on the setting of "Other bits in this word" in "Individual Device Settings".
 [Clear]..... 
 [Do not clear].....When bits are written, the Display reads the corresponding word address from the External Device, sets particular bits of that word address to ON, and then returns the resulting address to the External Device. Note that the data may not be written correctly if you write to the word address using the ladder program while the Display is reading data from, and writing data to, the External Device.
- *6 For the use of Extended Data Register.
- *7 For the Q00UCPU or Q01UCPU.
- *8 External Link Register can be used in the CPU of which first 5 digits of serial No. is 09042 or later.
- *9 For the use of Extended Link Register.
- *10 For the Multi CPU System configuration, the available points should be as follows:
 2 CPUs: 14k points or less
 3 CPUs: 13k points or less
 4 CPUs: 12k points or less
- *11 File Register, Extended Data Register and Extended Link Register cannot be used in the Q00UJCPU.
- *12 Set the block No. on the head of device name. This is the device name for conversion with GP-Pro/PB III for Windows. When you newly specify the device, we recommend that you should use the file register (Block switching is not necessary).

NOTE

- The notation of addresses differs depending on a selected Unit No.
 <Ex.>When 0 is selected for Unit No.,

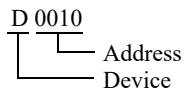

<Ex.>When 1 is selected for Unit No.,

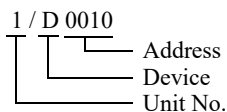

- Please refer to the GP-Pro EX Reference Manual for system data area.
 Cf. GP-Pro EX Reference Manual "LS Area (Direct Access Method Area)"
- Please refer to the precautions on manual notation for icons in the table.
 "Manual Symbols and Terminology"

6.3 Q Series Motion Controller (Q□□□HCPU)

□□□□□□□□ This address can be specified as system data area.

Device	Bit Address	Word Address	32 bits	Notes
Input Relay	X0000-X1FFF	X0000-X1FF0	L/H	***0
Output Relay	Y0000-Y1FFF	Y0000-Y1FF0		***0
Internal Relay	M00000-M08191	M00000-M08176		+16
Special Relay	SM0000-SM0255	SM0000-SM0240		+16
Latch Relay	L00000-L08191	L00000-L08176		+16
Annunciator	F00000-F02047	F00000-F02032		+16
Link Relay	B0000-B1FFF	B0000-B1FF0		***0
Data Register	-----	D0000000-D0008191		Bit F *1
Special Register	-----	SD0000-SD0255		Bit F *1
Link Register	-----	W0000-W1FFF		Bit F *1
Motion Register (#)*2	-----	%MR0000- %MR8191*3		Bit F *1

*1 The access method when specifying bits is different depending on the setting of "Other bits in this word" in "Individual Device Settings".

[Clear] Bit F

[Do not clear] When bits are written, the Display reads the corresponding word address from the External Device, sets particular bits of that word address to ON, and then returns the resulting address to the External Device. Note that the data may not be written correctly if you write to the word address using the ladder program while the Display is reading data from, and writing data to, the External Device.

*2 No. 2 to No. 4 can be allocated to the motion CPU.

*3 Device name with motion CPU is #.

NOTE

- The notation of addresses differs depending on a selected Unit No.
<Ex.>When 0 is selected for Unit No.,

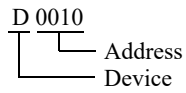



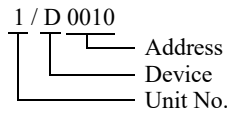











- <Ex.>When 1 is selected for Unit No.,

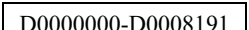

- Please refer to the GP-Pro EX Reference Manual for system data area.
Cf. GP-Pro EX Reference Manual "LS Area (Direct Access Method Area)"
- Please refer to the precautions on manual notation for icons in the table.
☞ "Manual Symbols and Terminology"

6.4 Q Series Motion Controller (Q□□□DCPU)

 This address can be specified as system data area.

Device	Bit Address	Word Address	32 bits	Notes
Input Relay	X0000-X1FFF	X0000-X1FF0	[L/H]	
Output Relay	Y0000-Y1FFF	Y0000-Y1FF0		
Internal Relay	M00000-M12287	M00000-M12272		
Special Relay	SM0000-SM2255	SM0000-SM2240		
Annunciator	F00000-F02047	F00000-F02032		
Link Relay	B0000-B1FFF	B0000-B1FF0		
Data Register	-----	 D0000000-D0008191		 *1
Special Register	-----	SD0000-SD2255		 *1
Link Register	-----	W0000-W1FFF		 *1
Common device for Multiple CPU*2	-----	U3E0-10000 - U3E0-24335		 *1
	-----	U3E1-10000 - U3E1-24335	 *1	
	-----	U3E2-10000 - U3E2-24335	 *1	
	-----	U3E3-10000 - U3E3-24335	 *1	
Motion Register (#)*3	-----	%MR00000- %MR12287*4	 *1	

*1 The access method when specifying bits is different depending on the setting of "Other bits in this word" in "Individual Device Settings".

[Clear] 

[Do not clear] When bits are written, the Display reads the corresponding word address from the External Device, sets particular bits of that word address to ON, and then returns the resulting address to the External Device. Note that the data may not be written correctly if you write to the word address using the ladder program while the Display is reading data from, and writing data to, the External Device.

*2 For the Multi CPU System configuration, the available points should be as follows:

2 CPUs: 14k points or less

3 CPUs: 13k points or less

4 CPUs: 12k points or less

*3 No. 2 to No. 4 can be allocated to the motion CPU.

*4 Device name with motion CPU is #.

NOTE

- The notation of addresses differs depending on a selected Unit No.

<Ex.>When 0 is selected for Unit No.,

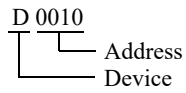

<Ex.>When 1 is selected for Unit No.,

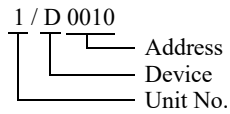

- Please refer to the GP-Pro EX Reference Manual for system data area.
Cf. GP-Pro EX Reference Manual "LS Area (Direct Access Method Area)"
 - Please refer to the precautions on manual notation for icons in the table.
☞ "Manual Symbols and Terminology"
-

7 Device Code and Address Code

Use device code and address code when you select "Device Type & Address" for the address type in data displays.

Device	Device Name	Device Code (HEX)	Address Code
Input Relay	X	0080	Value of word address divided by 0x10
	1/X	0180	
	2/X	0280	
	3/X	0380	
	4/X	0480	
Output Relay	Y	0081	Value of word address divided by 0x10
	1/Y	0181	
	2/Y	0281	
	3/Y	0381	
	4/Y	0481	
Internal Relay	M	0082	Value of word address divided by 16
	1/M	0182	
	2/M	0282	
	3/M	0382	
	4/M	0482	
Special Relay	SM	0083	Value of word address divided by 16
	1/SM	0183	
	2/SM	0283	
	3/SM	0383	
	4/SM	0483	
Latch Relay	L	0084	Value of word address divided by 16
	1/L	0184	
	2/L	0284	
	3/L	0384	
	4/L	0484	

Device	Device Name	Device Code (HEX)	Address Code
Annunciator	F	0085	Value of word address divided by 16
	1/F	0185	
	2/F	0285	
	3/F	0385	
	4/F	0485	
Edge Relay	V	0086	Value of word address divided by 16
	1/V	0186	
	2/V	0286	
	3/V	0386	
	4/V	0486	
Step Relay	S	0087	Value of word address divided by 16
	1/S	0187	
	2/S	0287	
	3/S	0387	
	4/S	0487	
Link Relay	B	0088	Value of word address divided by 0x10
	1/B	0188	
	2/B	0288	
	3/B	0388	
	4/B	0488	
Special Link Relay	SB	0089	Value of word address divided by 0x10
	1/SB	0189	
	2/SB	0289	
	3/SB	0389	
	4/SB	0489	
Timer (Current Value)	TN	0060	Word Address
	1/TN	0160	
	2/TN	0260	
	3/TN	0360	
	4/TN	0460	

Device	Device Name	Device Code (HEX)	Address Code
Retentive Timer (Current Value)	SN	0062	Word Address
	1/SN	0162	
	2/SN	0262	
	3/SN	0362	
	4/SN	0462	
Counter (Current Value)	CN	0061	Word Address
	1/CN	0161	
	2/CN	0261	
	3/CN	0361	
	4/CN	0461	
Data Register / External Data Register	D	0000	Word Address
	1/D	0100	
	2/D	0200	
	3/D	0300	
	4/D	0400	
Special Register	SD	0001	Word Address
	1/SD	0101	
	2/SD	0201	
	3/SD	0301	
	4/SD	0401	
Link Register / External Link Register	W	0002	Word Address
	1/W	0102	
	2/W	0202	
	3/W	0302	
	4/W	0402	
Special Link Register	SW	0003	Word Address
	1/SW	0103	
	2/SW	0203	
	3/SW	0303	
	4/SW	0403	

Device	Device Name	Device Code (HEX)	Address Code
Common device for Multiple CPU	U3E0-	0035	Word Address
	1/U3E0-	0135	
	2/U3E0-	0235	
	3/U3E0-	0335	
	4/U3E0-	0435	
	U3E1-	0036	Word Address
	1/U3E1-	0136	
	2/U3E1-	0236	
	3/U3E1-	0336	
	4/U3E1-	0436	
	U3E2-	0037	Word Address
	1/U3E2-	0137	
	2/U3E2-	0237	
	3/U3E2-	0337	
	4/U3E2-	0437	
	U3E3-	0038	Word Address
1/U3E3-	0138		
2/U3E3-	0238		
3/U3E3-	0338		
4/U3E3-	0438		
File Register (Normal)	R	000F	Word Address
	1/R	010F	
	2/R	020F	
	3/R	030F	
	4/R	040F	
File Register (Block switching is not necessary)	ZR	000E	Word Address
	1/ZR	010E	
	2/ZR	020E	
	3/ZR	030E	
	4/ZR	040E	

Device	Device Name	Device Code (HEX)	Address Code
File Register (0R-31R)	0R	0010	Word Address
	1/0R	0110	
	2/0R	0210	
	3/0R	0310	
	4/0R	0410	
	1R	0011	Word Address
	1/1R	0111	
	2/1R	0211	
	3/1R	0311	
	4/1R	0411	
	2R	0012	Word Address
	1/2R	0112	
	2/2R	0212	
	3/2R	0312	
	4/2R	0412	
	:	:	:
	30R	002E	Word Address
	1/30R	012E	
	2/30R	022E	
	3/30R	032E	
4/30R	042E		
31R	002F	Word Address	
1/31R	012F		
2/31R	022F		
3/31R	032F		
4/31R	042F		
Motion Register (#)	2/%MR	0234	Word Address
	3/%MR	0334	
	4/%MR	0434	

8 Error Messages

Error messages are displayed on the screen of Display as follows: "No.: Device Name: Error Message (Error Occurrence Area)". Each description is shown below.

Item	Description
No.	Error No.
Device Name	Name of External Device where error occurs. Device name is a title of External Device set with GP-Pro EX.(Initial value [PLC1])
Error Message	Displays messages related to the error which occurs.
Error Occurrence Area	<p>Displays IP address or device address of External Device where error occurs, or error codes received from External Device.</p> <p>NOTE</p> <ul style="list-style-type: none"> • IP address is displayed such as "IP address (Decimal): MAC address (Hex)". • Device address is displayed such as "Address: Device address". • Received error codes are displayed such as "Decimal [Hex]".

Display Examples of Error Messages

"RHAA035: PLC1: Error has been responded for device write command (Error Code: 2 [02H])"

-
- NOTE**
- Refer to your External Device manual for details on received error codes.
 - Refer to "Display-related errors" in "Maintenance/Troubleshooting Guide" for details on the error messages common to the driver.
-

