

Essential Safety Precautions

WARNINGS

System Design

- Do not create GP touch panel switches that could possibly endanger the safety of equipment and personnel. Damage to the GP, its I/O unit(s), cable(s), and other related equipment can cause an output signal to remain continuously ON or OFF and possibly cause a major accident. Therefore, design all monitoring circuits using limit switches, etc. to detect incorrect device movement. To prevent accidents related to incorrect signal output or operation, design all switches used to control vital machine operations so they are operated via a separate control system.
- Do not create switches used to control machine safety operations, such as an emergency stop switch, as a GP touch screen icon. Be sure to install these switches as separate hardware switches, otherwise severe bodily injury or equipment damage can occur.
- Do not use the GP unit as a warning device for critical alarms that can cause serious operator injury, machine damage or production stoppage. Critical alarm indicators and their control/activator units must be designed using stand-alone hardware and/or mechanical interlocks.
- Please design your system so that equipment will not malfunction due to a communication fault between the GP and its host controller. This is to prevent any possibility of bodily injury or material damage.
- The GP is not appropriate for use with aircraft control devices, aerospace equipment, central trunk data transmission (communication) devices, nuclear power control devices, or medical life support equipment, due to these devices' inherent requirements of extremely high levels of safety and reliability.
- When using the GP with transportation vehicles (trains, cars and ships), disaster and crime prevention devices, various types of safety equipment, non-life support related medical devices, etc. redundant and/or failsafe system designs should be used to ensure the proper degree of reliability and safety.
- After the GP's backlight burns out, unlike the GP's "Standby Mode", the touch panel is still active. If the operator fails to notice that the backlight is burned out and touches the panel, a potentially dangerous machine miss-operation can occur. Therefore, do not use GP touch switches for the control of any equipment safety mechanisms, such as Emergency Stop switches, etc. that protect humans and equipment from injury and damage. If your GP's backlight suddenly turns OFF, use the following steps to determine if the backlight is actually burned out.
 - 1) If your GP is not set to "Standby Mode" and the screen has gone blank, your backlight is burned out.
 - 2) Or, if your GP is set to "Standby Mode", but touching the screen does not cause the display to reappear, your backlight is burned out.Also, to prevent accidental machine miss-operation, Digital suggests you use the GP's built-in "USE TOUCH PANEL AFTER BACKLIGHT BURNOUT" feature, that will automatically detect a burnout and disable the touch screen.

Installation

- High voltage runs through the GP. Except for replacing the backlight, never disassemble the GP, otherwise an electric shock can occur.
- Do not modify the GP unit. Doing so may cause a fire or an electric shock.
- Do not use the GP in an environment where flammable gasses are present, since operating the GP may cause an explosion.

Wiring

- To prevent an electric shock, be sure to confirm that the GP's power cord is not connected to the main power when connecting any cords, cables or lines to the GP.
- Be sure to replace the GP's plastic terminal block cover after wiring is completed, since operating the GP without the cover may lead to an electric shock.
- Do not use power beyond the GP's specified voltage range. Doing so may cause a fire or an electric shock.

Maintenance

- The GP uses a lithium battery for backing up its internal clock data. If the battery is incorrectly replaced, the battery may explode. To prevent this, please do not replace the battery yourself. When the battery needs to be replaced, please contact your local GP distributor.

CAUTIONS

Installation

- Be sure to securely connect all cable connectors to the GP. A loose connection may cause incorrect input or output.

Wiring

- Ground the GP's FG line separately from other units' FG lines. Putting these FG lines too close may cause an electric shock or unit malfunction. Be sure to use a grounding resistance of 100Ω or less and a 2mm² or thicker wire, or your country's applicable standard.
- Correctly wire the GP, be sure that the rated voltage and terminal layout are within the designated range. If the voltage supplied differs from the rated voltage, or incorrect wiring or grounding is performed, it may cause a fire or unit malfunction.
- Use only the designated torque to tighten the GP's terminal block screws. If these screws are not tightened firmly, it may cause a short-circuit, fire, or GP malfunction.
- Be careful that metal filings and wiring debris do not fall inside the GP, since they can cause a fire, GP malfunction, or incorrect operation.

Maintenance

- The liquid crystal panel contains a powerful irritant and if for any reason the panel is damaged and this liquid contacts any part of your body, be sure to wash that area with running water for 15 minutes. If any of this liquid enters your eye, flush your eye for 15 minutes with running water and contact a physician.
- Prior to inserting or removing a CF Card, be sure to turn the GP's CF Card ACCESS switch OFF and to confirm that the ACCESS lamp is not lit. If you do not, CF Card internal data may be damaged or lost.
- While a CF Card is being accessed, NEVER turn OFF or reset the GP, or insert or remove the CF Card. Prior to performing these operations, create and use a special GP application screen that will prevent access to the CF Card.

Unit Disposal

- When this unit is disposed of, it should be done so according to your country's regulations for similar types of industrial waste.

General Safety Precautions

- Do not strike the touch panel with a hard or pointed object, or press on the touch panel with too much force, since it may damage the touch panel or the display.
- Do not install the GP where the ambient temperature can exceed the allowed range. Doing so may cause the GP to malfunction or shorten its operation life.
- Do not restrict or limit the GP's naturally occurring rear-face ventilation, or storing or using the GP in an environment that is too hot.
- Do not use this unit in areas where large, sudden temperature changes can occur. These changes can cause condensation to form inside the unit, possibly causing the unit to malfunction.
- Do not allow water, liquids, metal or charged particles to enter inside the GP's case, since they can cause either a GP malfunction or an electrical shock. The allowable pollution degree is 2.
- Do not use or store the GP in direct sunlight, or in excessively dusty or dirty environments.
- Do not store or use the unit where strong jolting or excessive vibration can occur.
- Do not store or use the GP where chemicals (such as organic solvents, etc.) and acids can evaporate, or where chemicals and acids are present in the air.
Corrosive chemicals: Acids, alkalines, liquids containing salt
Flammable chemicals: Organic Solvents
- Do not use paint thinner or organic solvents to clean the GP.
- Do not store or operate the LCD display in areas receiving direct sunlight, since the sun's UV rays may cause the LCD display's quality to deteriorate.
- Storing this unit in areas at a temperature lower than is recommended in this manual's specifications may cause the LCD display's liquid to congeal, which may damage the panel. Conversely, if the storage area's temperature becomes higher than the allowed level, the LCD's liquid will become isotropic, causing irreversible damage to the LCD. Therefore, be sure to store the panel only in areas where temperatures are within those specified in this manual.
- After turning the GP OFF, be sure to wait a few seconds before turning it ON again. If the GP started too soon, it may not start up correctly.
- Due to the possibility of unexpected accidents, be sure to back up the GP's screen data regularly.

UL/c-UL(CSA) Approval

The GP2501-TC11*¹, GP2501-SC11*¹ and the GP2601-TC11*¹ are UL/c-UL(CSA) recognized components. (UL file No. E231702)

This Unit conforms as a component to the following standards:

■ **UL1604**

Electrical Equipment for Use in Class I and II Division 2 and Class III Hazardous (Classified) Locations

■ **UL60950**

Safety Standard for Information Technology Equipment (3rd Edition, issued December 1, 2001)

■ **CAN/CSA-C22.2, No.60950-00**

Safety Standard for Information Technology Equipment (3rd Edition, issued December 1, 2001)

■ **CAN/CSA-C22.2, No.213-M1987**

Safety Standard for Information Technology and Electrical Business Equipment

GP2501-TC11 (UL Registration Model : 3180021-03)

GP2501-SC11 (UL Registration Model : 3180021-04)

GP2601-TC11 (UL Registration Model : 3180021-05)

<Cautions>

- The GP must be used as a built-in component of an end-use product.
- The GP units must be used indoors only.
- The GP should be installed in the front face of a metal panel.
- If the GP is installed so as to cool itself naturally, be sure to install it in a vertical panel. Also, be sure that the GP is mounted at least 100mm away from adjacent structures and other equipment, otherwise, the heat generated by the GP's internal components may become higher than that allowed by UL standard requirements.
- Make sure to set up a switch to turn off the power to the GP in an accessible position on the end-use product that the GP unit is built-in. Make sure to consider the current and voltage when selecting the switch.
- Make sure that the frame of the product to which the GP unit is built-in conforms to UL60950 standard requirements.

UL1604 Conditions of Acceptability and Handling Cautions:

1. Power, input and output (I/O) wiring must all be in accordance with Class I, Division 2 wiring methods, Article 501-4 (b) of the National Electrical Code, NFPA 70, or as specified in Section 18-152 of the Canadian Electrical Code for units installed within Canada, and in accordance with that location's authority.
2. Suitable for use in Class I, Division 2, Groups A, B, C and D hazardous location.
3. **WARNING:** Explosion hazard - substitution of components may impair suitability for Class I, Division 2.
4. **WARNING:** Explosion hazard - when in hazardous locations, turn the power off before replacing or wiring modules.
5. **WARNING:** Explosion hazard - do not disconnect equipment unless power has been switched off or the area is known to be nonhazardous.
6. **WARNING:** Explosion hazard - do not connect/ disconnect equipment unless area is known to be nonhazardous. Port is for system set up and diagnostics.

CE Marking

The GP2501-TC11*¹, GP2501-SC11*¹ and the GP2601-TC11*¹ are CE marked products that conform to EMC directives and the Low-voltage directive. These units also conform to EN55011 ClassA, EN61000-3-2, EN-61000-3-3, EN61000-6-2, EN60950 directives.

For detailed CE marking information, please contact your local distributor.

<Cautions>

- The GP must be used as a built-in component of an end-use product.
- The GP units must be used indoors only.
- The GP should be installed in the front face of a metal panel.
- If the GP is installed so as to cool itself naturally, be sure to install it in a vertical panel. Also, be sure that the GP is mounted at least 100mm away from adjacent structures and other equipment, otherwise, the heat generated by the GP's internal components may become higher than that allowed by the standard requirements.
- Make sure to set up a switch to turn off the power to the GP in an accessible position on the end-use product that the GP unit is built-in. Make sure to consider the current and voltage when selecting the switch.
- Make sure that the frame of the product to which the GP unit is built-in conforms to EN60950 standard requirements.

Revision Version

The revision version can be determined by the identification label or revision stickers that are placed on the main unit of the GP. The characters and numerals in the "REV" area that are replaced with asterisks (*), or marked with a marker indicate the revision version.

In the example below, the asterisks "*" are placed at positions "D", "1", and "2", which indicates the revision version as "D, 1, 2".

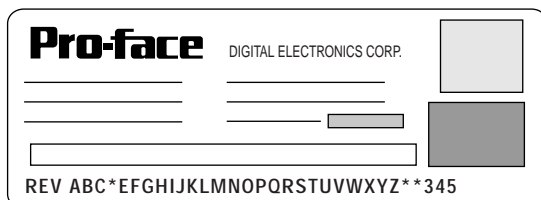

Identification Label



Revision Sticker

***1** *The products on which Revision "3" is marked conform to the standard requirements. For more information on how to determine the revision version, refer to section "Revision Version".*

Package Contents

The following items are included in the GP's package. Before using the GP, please confirm that all items listed here are present.

- **GP Unit (1)**
(GP2501-TC11/
GP2501-SC11/
GP2601-TC11)

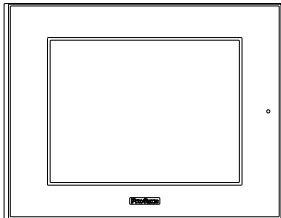

- **Installation Guide (1)**
<This Guide>



- **Installation Fasteners (4/set)**
- **Installation Gasket (1)**

This unit has been carefully packed, with special attention to quality. However, should you find anything damaged or missing, please contact your local GP distributor immediately.

1 Part Names

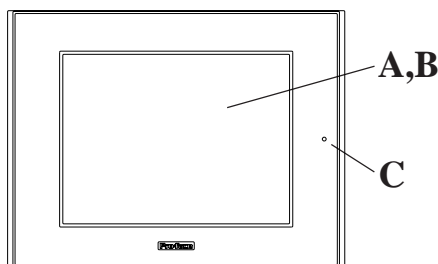

- A : Display
- B : Touch Panel
- C : Status LED

LED	GP Status
Not Lit	Power is OFF.
Green	Normal operation
Orange	Backlight is not functioning. (Refer to 10.Replacing the Backlight.)

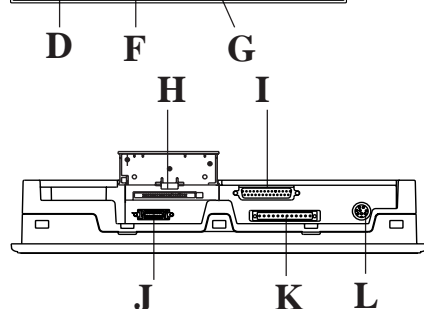
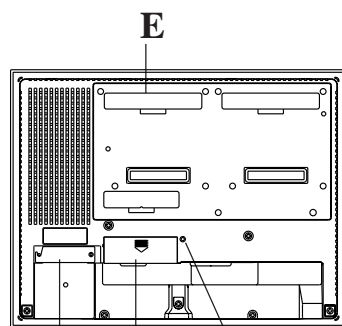

- D : Power Input Terminal Block
- E : Expansion Unit I/F
- F : CF Card Cover
- G : CF Card Access Lamp
- H : CF Card I/F
- I : Serial Interface (HOST-I/F 25-pin)
- J : Printer I/F (Half Pitch 20-pin)
- K : Auxiliary Input/Output Interface
- L : Tool Connector
Connects a Data Transfer Cable or bar code reader

2 Dimensions

Unit:mm [in]

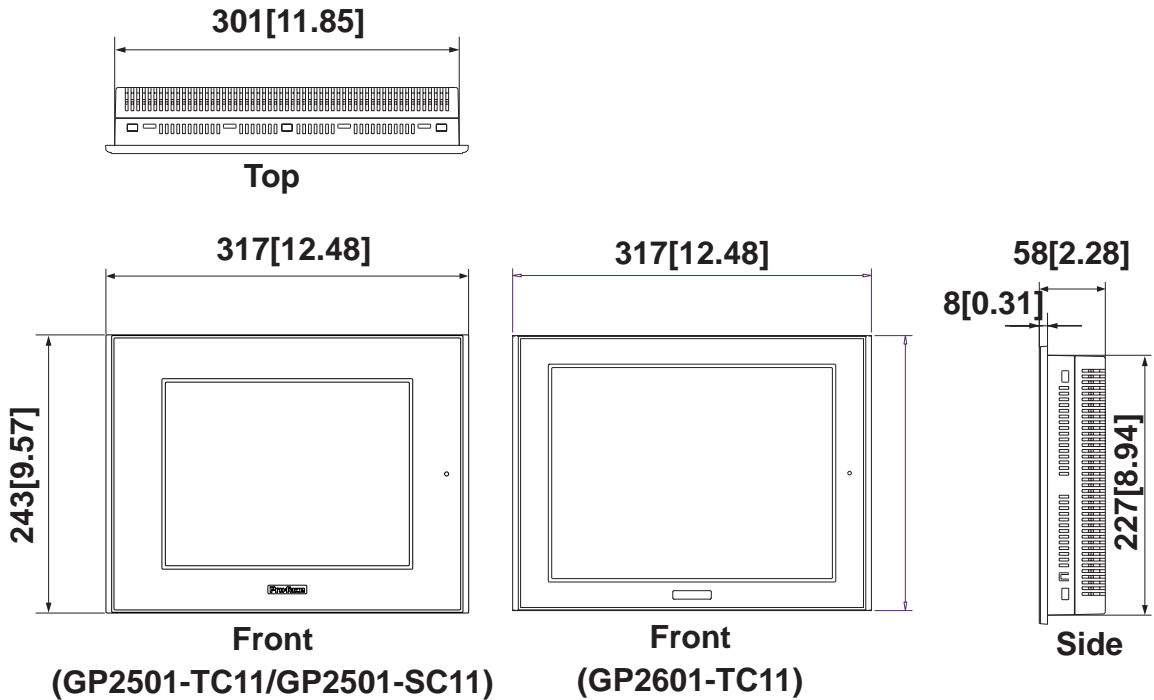

3 Dip Switches

These switches are located inside the CF Card's cover.
The factory settings for these switches are OFF.

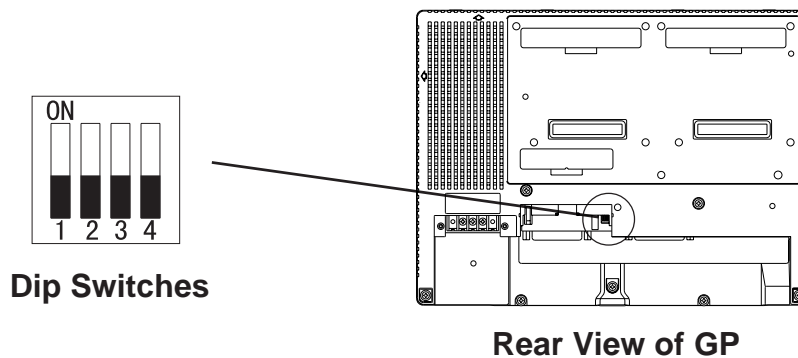

Dip Switch	Function	ON	OFF	Note
1	This Dip switch setting controls the startup from a CF Card.	Startup from CF Card is enabled.	Startup from CF Card is disabled.	CF Card with startup data required.
2	Reserved	—	—	Keep these switches OFF
3	Reserved	—	—	
4	This setting controls the forced closing of the CF Card cover.	Forced close enabled.	Forced close disabled.	Used when CF Card cover is damaged.

4 Interfaces

■ Serial Interface (HOST-I/F)

This interface is used to connect the GP to the host (PLC), via an RS-232C or RS-422 cable.

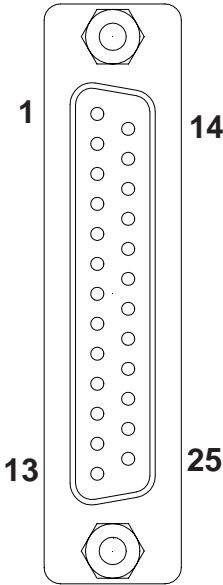
Pin Arrangement	Pin #	Signal Name	Description
	1	FG	Frame Ground
	2	SD	Send Data (RS-232C)
	3	RD	Receive Data (RS-232C)
	4	RS	Request to Send (RS-232C)
	5	CS	Clear to Send (RS-232C)
	6	DR	Data Set Ready (RS-232C)
	7	SG	Signal Ground
	8	CD	Carrier Detect (RS-232C)
	9	TRMX	Termination (RS-422)
	10	RDA	Receive Data A (RS-422)
	11	SDA	Send Data A (RS-422)
	12	NC	No Connection(Reserved)
	13	NC	No Connection(Reserved)
	14	VCC	5V±5% Output 0.25A
	15	SDB	Send Data B (RS-422)
	16	RDB	Receive Data B (RS-422)
	17	RI	Ring Indicate (RS-232C)
	18	CSB	Clear to Send B (RS-422)
	19	ERB	Enable Receive B (RS-422)
	20	ER	Enable Receive (RS-232C)
	21	CSA	Clear to Send A (RS-422)
	22	ERA	Enable Receive A (RS-422)
	23	NC	No Connection(Reserved)
	24	NC	No Connection(Reserved)
	25	NC	No Connection(Reserved)

Recommended Connector: Dsub 25 pin plug XM2A-2501 <made by OMRON Corp.>

Recommended Cover : Dsub 25 pin Cover XM2S-2511 <made by OMRON Corp.>
Jack Screw XM2Z-0071 <made by OMRON Corp.>

Recommended Cable : CO-MA-VV-SB5P x 28AWG
<made by HITACHI Cable Ltd.>



- ***This GP unit's serial port is not isolated. When the host (PLC) unit is also not isolated, and to reduce the risk of damaging the RS-422 circuit, be sure to connect the #7 SG (Signal Ground) terminal.***
- ***Pin #14 (VCC) DC 5V Output is not protected. To prevent damage or unit malfunction, use only the designated level of current.***
- ***Inside the GP2501/2601 unit, the SG (Signal Ground) and FG (Frame Ground) terminals are connected to each other.***
- ***When connecting an external device to the GP with the SG terminal, ensure that no short-circuit loop is created when you setup the system.***



Use rough metric type M2.6 x 0.45p threads to hold the cable's set (fastening) screws in place.

When creating a cable, please be aware of the following:

<For RS-422 Connectors>

- **The following pairs of pin no.s must be connected (shorted).**
 ...#18 (CSB) <-> #19 (ERB)
 ...#21 (CSA) <-> #22 (ERA)
- **Connecting the #9 (TRMX) and #10 (RDA) wires, adds a termination resistance of 100Ω between RDA and RDB.**
- **Use a 4-wire cable when the PLC type is Memory Link and the cable is RS-422.**

<For RS-232C Connectors>

- **Do not connect #9 (TRMX), #10 (RDA), #11 (SDA), #15 (SDB), #16 (RDB), #18 (CSB), #19 (ERB), #21 (CSA), and #22 (ERA).**
- **The #1 (FG) terminal should only be connected if it is required by the device being connected to.**

■ Printer Interface (Half Pitch 20-pin)

When connecting a printer, use Digital's printer cable (PSM-PRCB00).

Pin Arrangement	Pin #	Signal Name	Description
	1	GND	Ground
	2	RESERVED	Reserved
	3	PDB5	Data Signal
	4	PDB4	Data Signal
	5	PDB3	Data Signal
	6	GND	Ground
	7	SLCT	Select Condition(Input)
	8	PDB0	Data Signal
	9	$\overline{\text{PSTB}}$	Strobe Signal(Output)
	10	BUSY	Busy Signal(Input)
	11	PDB7	Data Signal
	12	PDB6	Data Signal
	13	GND	Ground
	14	$\overline{\text{ERROR}}$	Printer Error(Input)
	15	GND	Ground
	16	PDB2	Data Signal
	17	PDB1	Data Signal
	18	PE	Paper End
	19	$\overline{\text{INIT}}$	Initialize Signal(Output)
	20	GND	Ground

■ Auxiliary Input/Output Interface (12 pin)

This interface performs external reset, alarm output, and buzzer output.

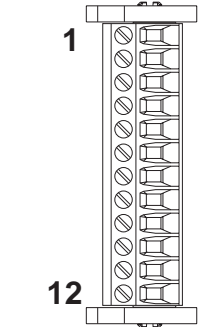
Pin Arrangement	I/F	Pin No.	Signal Name	Description
	External Reset	1	AUXCOM	External Reset Common
		2	AUXRESET	External Reset Input
	AUX	3	RUN	Online
		4	ALARM	System Alarm Output
		5	OUTCP	24VDC
		6	BUZZ	External Buzzer Output
		7	RESERVE	Reserved
		8	OUTCN	0V
		9	RESERVE	Reserved
		10	RESERVE	Reserved
		11	RESERVE	Reserved
		12	RESERVE	Reserved



- **Using the AUX Input/Output I/F requires the sold separately Screw Lock Terminal Block (GPL-AXCN01).**

■ CF Card Interface

This slot accepts a CF Card.

■ Expansion Unit Interface

This interface is used to connect an expansion unit that can transmit data over a Fieldbus or similar type of network.

5 Installation

■ Confirm the Installation Gasket's Positioning

It is strongly recommended that you use the gasket. It absorbs vibration in addition to repelling water.

Place the GP on a level surface with the display panel facing downward. Check that the GP's installation gasket is seated securely into the gasket's groove, which runs around the perimeter of the panel's frame.



- **Before installing the GP into a cabinet or panel, check that the installation gasket is securely attached to the unit.**
- **Be sure the gasket's seam is not inserted into any of the unit's corners, only in the straight sections of the groove. Inserting it into a corner may lead to its eventually tearing.**
- **A gasket which has been used for a long period of time may have scratches or dirt on it, and could have lost much of its dust and drip resistance. Be sure to change the gasket periodically (or when scratches or dirt become visible).**

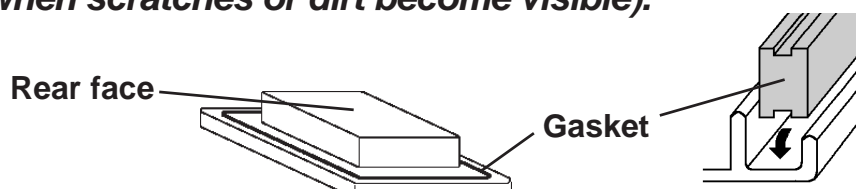

■ **Create a Panel Cut and insert the GP into the panel from the front**

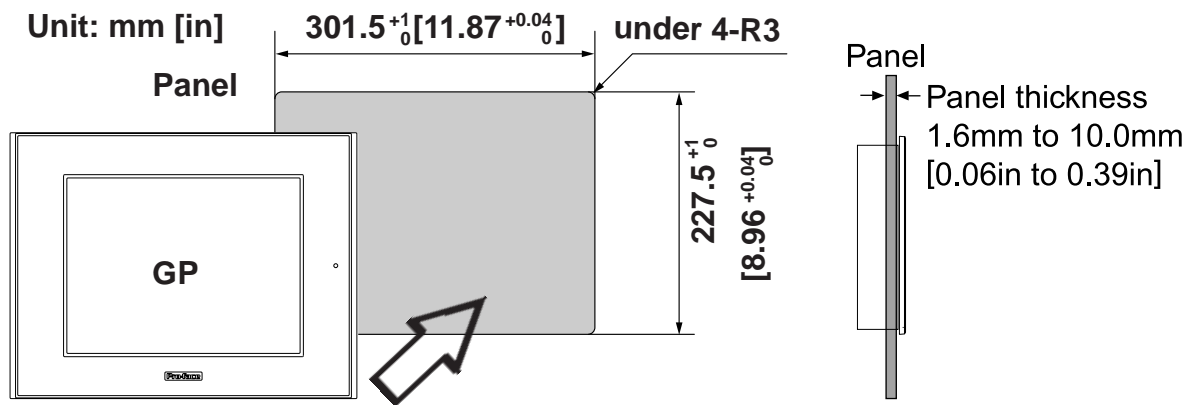

■ **Attach the Installation Fasteners from Inside the Panel**

The following figures show the four(4) fastener insertion slot locations. Insert each fastener's hook into the slot and tighten it with a screwdriver.

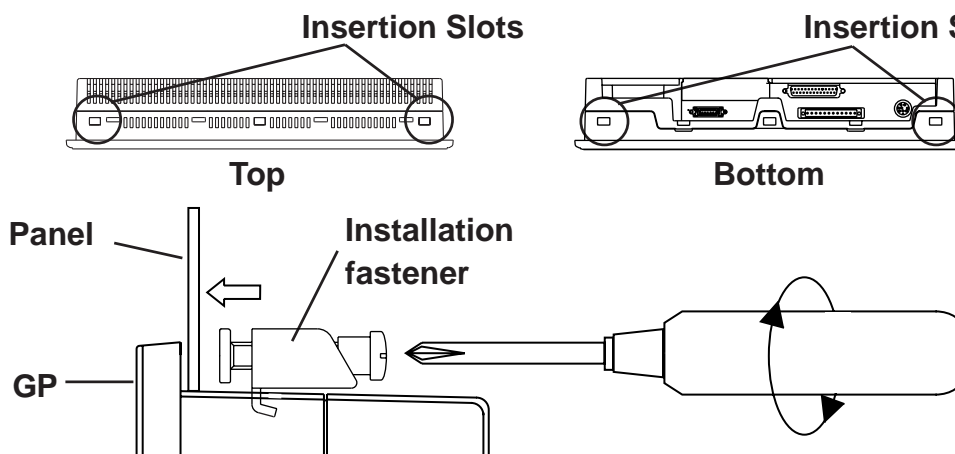

- **Tightening the screws with too much force can damage the GP's plastic case.**
- **The necessary torque is 0.5 N•m.**



- Depending on the installation panel's thickness, etc., the number of installation fasteners used may need to be increased to provide the desired level of moisture resistance.

6 Wiring

! WARNINGS

- To avoid an electric shock, when connecting the GP's power cord terminals to the power terminal block, confirm that the GP's power supply is completely turned OFF, via a breaker, or similar unit.
- GP2501-TC11/GP2501-SC11/GP2601-TC11 units that are not marked as REV "3" are designed for use only with 100 VAC input.
- Since there is no power switch on the GP unit, be sure to attach a breaker-type switch to its power cord.



- **To avoid a short caused by loose ring terminals, be sure to use ring terminals with an insulating sleeve.**
- **When the FG terminal is connected, be sure the wire is grounded. Not grounding the GP unit will result in excess noise and vibration.**



- Note:**
- **Wherever possible, use thick wires (max. 2 mm²) for power terminals, and twist the wire ends before attaching the ring terminals.**
 - **Be sure to use the following size ring terminals.**

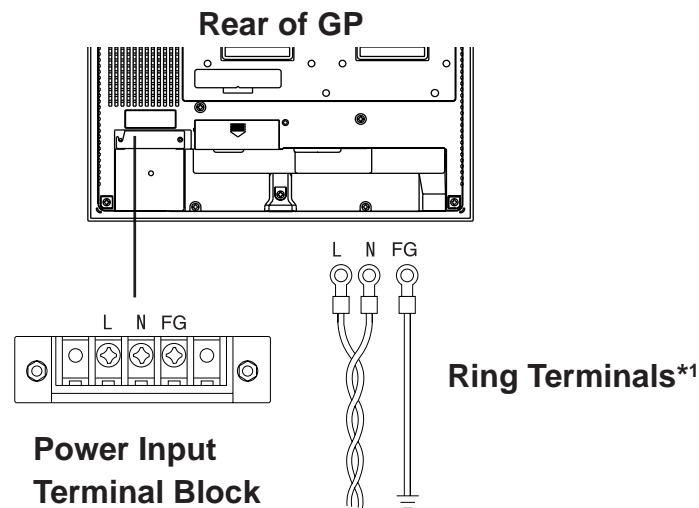
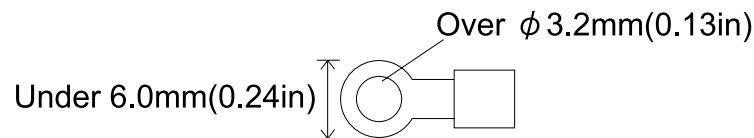

■ Connecting the GP Power Cord

When connecting the power cord, be sure to follow the procedures given below.

1. Confirm that the GP's Power Cord is unplugged from the power supply.
2. Use a screwdriver to remove the Power Input Terminal Block's clear plastic cover.
3. Unscrew the screws from the middle three (3) terminals, align the Ring Terminals and re-attach the screws.
4. Replace the Power Input Terminal Block's clear plastic cover.



- **Confirm that the ring terminal wires are connected correctly.**
- **The torque required to tighten these screws is 0.5 to 0.6 N•m.**

***1** *L=AC Input Live Line*
N=AC Input Neutral Line
FG=Grounding Terminal connected to the GP chassis.
Suggested Ring Terminal : equivalent to V2-MS3 (made by JST)

7 Power Supply Cautions

Please pay special attention to the following instructions when connecting the power cord terminals to the GP unit.

- If the power supply voltage exceeds the GP's specified range, connect a voltage transformer.
- Between the line and the ground, be sure to use a low noise power supply. If there is still an excessive amount of noise, connect a noise reducing transformer.
- Input and Output signal lines must be separated from the power control cables for operational circuits.
- To increase the noise resistance, be sure to twist the ends of the power cord wires before connecting them to the GP unit.
- The GP's power supply cord should not be bundled with or kept close to main circuit lines (high voltage, high current), or input/output signal lines.
- Connect a surge absorber to handle power surges.
- To reduce noise, make the power cord as short as possible.

8 Grounding Caution

- When grounding to the GP's rear face FG terminal, (on the Power Input Terminal Block), be sure to create an exclusive ground.*1
- Inside the GP2501/2601 unit, the SG(Signal Ground) and FG(Frame Ground) terminals are connected to each other.
- When connecting an external device to the GP with the SG terminal, ensure that no short-circuit loop is created when you setup the system.
- When attaching an expansion unit to the GP, be sure to read the expansion unit's Installation Guide.

9 Input/Output Signal Line Cautions

- All GP Input and Output signal lines must be separated from all operating circuit (power) cables.
- If this is not possible, use a shielded cable and ground the shield.

10 Replacing the Backlight

The GP unit's backlight is user replacable.



Use of a different model backlight may cause a GP malfunction or breakdown.

For an explanation of how to replace the GP's backlight, please refer to the User Manual or the Installation Guide which comes with the replacement backlights (sold separately).

Corresponding Replacement Backlights

GP Unit	Rev.	Backlight Model
GP2501-TC11	-	GP577RT-BL00-MS
GP2501-SC11		PS501S-BU00
GP2601-TC11 *2	Rev.4 is marked	CA3-BLU12-01
	The others	PS600-BU00

*1 Use a grounding resistance of 100Ω, a wire of 2mm² or thicker, or your country's applicable standard.

*2 For GP-2601 Series, the backlight differs depending on a Rev. For the correct backlight and how to distinguish Rev., refer to the User Manual carried in the Pro-face Web Site (<http://www.pro-face.com/>).