

**Digital**  
*Human Machine Interface* ———

**Pro-face**

**FP3700-T41**  
**User Manual**

**Digital**  
Digital Electronics Corporation

# Preface

---

Thank you for purchasing Digital's TFT type color display panel, the 'FP3700-T41' (hereafter referred to as the *FP unit*).

The FP unit is a TFT type color liquid crystal display monitor for Windows® compatible personal computers (XGA mode).

Please read this manual completely to insure the correct use and complete understanding of the FP unit's functions. The FP's analog interface and DVI-D interface are designed for using standard VGA mode. Be aware that this unit may not be able to be connected using a nonstandard VGA mode. For more details, please refer to this manual's "PC Connectivity Notes" section.

<Note>

- 1) It is forbidden to copy the contents of this manual, in whole or in part, except for the user's personal use, without the express permission of Digital Electronics Corporation of Japan.
- 2) The information provided in this manual is subject to change without notice.
- 3) This manual has been written with care and attention to detail; however, should you find any errors or omissions, please contact Digital Electronics and inform them of your findings.
- 4) Regardless of the above clause, Digital Electronics Corporation shall not be held responsible for any damages or third-party claims for damages or losses resulting from the use of this product.

All Company/Manufacturer names used in this manual are the registered trademarks of their respective companies.

©2003, Digital Electronics Corporation

# Essential Safety Precautions

---

This manual describes safety instructions for correct use of the FP unit. Please keep this manual close at hand and refer to it when necessary.

The following symbols are used throughout this manual to ensure the safe use of the FP unit. Please be sure to follow all instructions given since they explain important safety points.



Indicates situations where severe bodily injury, death or major equipment damage will occur.



Indicates situations where bodily injury or machine damage can occur.

# Documentation Conventions

---

The list below describes the symbols used in this manual.



Explains a situation that requires a moderate amount of caution.



Indicates a word or phrase that has an additional explanation.

\*1 A reference point. Describes the word or phrase marked by the asterisk (\*) and the corresponding number.

**Reference** Indicates related information.

- 1),
  - 2)
- Operational steps. Please follow these numbered steps in order to perform the desired operation.

 **WARNINGS**

- Because of the ever present danger of electrical shock, be sure to unplug the power cable from the FP unit before plugging the cable's other end into the wall.
- Do not use power in excess of the unit's specified voltage range since it may cause a fire or electric shock.
- Because the FP unit contains high voltage parts, an electric shock can occur when disassembling the unit. Therefore, be sure to always unplug the unit before disassembling it.
- Do not modify the FP unit in any way, since it may cause a fire or electric shock.
- Do not use touch panel keys to perform life-threatening or vitally important safety functions. Use separate mechanical switches for such keys.
- Do not use the FP unit as a warning device for critical alarms that can cause serious operator injury, machine damage or production stoppage. Critical alarm indicators and their control/activator units must be designed using stand-alone hardware and/or mechanical interlocks.
- After the FP's backlight burns out, unlike the FP's "Standby Mode", the touch panel is still active. If the operator fails to notice that the backlight is burned out and touches the panel, a potentially dangerous machine miss-operation can occur. Therefore, do not use FP touch switches for the control of any equipment safety mechanisms, such as Emergency Stop switches, etc. that protect humans and equipment from injury and damage.

If your FP's backlight suddenly turns OFF, use the following steps to determine if the backlight is actually burned out.

1) If your current FP application is not set to turn the backlight OFF, and the screen has gone blank, your backlight is burned out.

2) If your current FP application is set to turn the backlight OFF, if touching the screen does not cause the display to reappear, your backlight is burned out.



## WARNINGS

- If substantial amounts of metallic dust, water or liquids enter the FP unit, turn off the power supply immediately, unplug the power cord, and contact your local FP distributor.
- When installing the FP unit, be sure to follow the instructions given in "Chapter 3 Installation and Wiring," to insure it is done correctly.
- Do not use the FP in an environment with flammable gas, since it may cause an explosion.
- The FP is not appropriate for use with aircraft control devices, aerospace equipment, central trunk data transmission (communication) devices, nuclear power control devices, or medical life support equipment, due to these devices' inherent requirements of extremely high levels of safety and reliability.
- When using the FP with transportation vehicles (trains, cars and ships), disaster and crime prevention devices, various types of safety equipment, non-life support related medical devices, etc, redundant and/or failsafe system designs should be used to ensure the proper degree of reliability and safety.



## CAUTIONS

- Do not press the screen's touch surface too strongly with either your finger or a hard object, since the touch surface may be damaged.
- When the surface of the display screen becomes dirty or smudged, clean the display with a cloth soaked in a neutral detergent. Do not use paint thinner or organic solvent.
- Do not press on the touch panel's face with sharp objects, such as a mechanical pencil or screwdriver, since it might damage the LCD panel.
- Avoid using or storing the FP in direct sunlight, excessively dusty or dirty environments, or where chemicals or their vapors are present in the air.
- Avoid restricting the FP's natural ventilation, or storing and using the FP in an environment that will increase the FP's internal temperature.
- Do not use the FP in areas where sudden, large changes in temperature may occur. These changes can cause condensation to form inside the unit, possibly causing an accident.
- Do not store or use the FP where chemicals (such as organic solvents, etc.) and acids can evaporate, or where chemicals and acids are present in the air.
- When the product is disposed of, it should be done so according to your country's regulations for similar types of industrial waste.

# General Safety Precautions

---

## Notes on the FP's Liquid Crystal Display (LCD)

For detailed LCD information, Please contact Digital's Development department, Product Quality Assurance group.

- The FP's LCD contains a strong irritant. If the panel is damaged and the LCD unit's liquid contacts your skin, be sure to wash it with running water for at least 15 minutes. If any of this liquid should enter your eye, be sure to flush the eye with running water for more than 15 minutes, and see a doctor immediately.
- The current brightness of the LCD screen will depend on the screen's current display and the LCD unit's contrast adjustment. Any brightness variations that result are normal for LCD displays.
- There are minute grid-points on the LCD surface. These points are not defects.
- The displayed color will look different when viewed from an angle outside the specified view angle. This is also normal.
- Displaying a single screen image for long periods of time can cause an afterimage to remain. To correct this, turn the unit OFF for 5 or 10 minutes, then turn it ON again. This phenomenon is a common attribute of the LCD unit's, and not a defect. To prevent this effect, you can:
  - use the Display OFF feature, if the same image is to be displayed for a long period of time.
  - change the screen display periodically to prevent the displaying of a single image for a long period of time.

# Table of Contents

- Preface ..... i
- Essential Safety Precautions ..... ii
- Documentation Conventions ..... ii
- General Safety Precautions ..... vi
- Connecting the FP to a PC ..... ix
- FP3700-T41 Features ..... x
- What is IP65f? ..... xi
- Package Contents ..... xii
- UL/c-UL (CSA) Application ..... xiii
- CE Marking ..... xiii

## CHAPTER 1 INTRODUCTION

- 1.1 System Design ..... 1-1
- 1.2 Optional Equipment ..... 1-2

## CHAPTER 2 SPECIFICATIONS

- 2.1 General Specifications ..... 2-1**
  - 2.1.1 Electrical Specifications ..... 2-1
  - 2.1.2 Environment Specifications ..... 2-1
  - 2.1.3 Structural Specifications ..... 2-2
- 2.2 Functional Specifications ..... 2-3**
  - 2.2.1 Performance ..... 2-3
  - 2.2.2 Display ..... 2-3
- 2.3 Interface Specifications ..... 2-4**
  - 2.3.1 Analog RGB Interface ..... 2-4
  - 2.3.2 DVI-D Interface ..... 2-6
  - 2.3.3 RS-232C Interface ..... 2-8
  - 2.3.4 USB Interface ..... 2-9
- 2.4 Cable Diagrams ..... 2-10**
  - 2.4.1 RGB Interface Cable Pin Connections (Option cable: VGA standard) ..... 2-10
  - 2.4.2 DVI-D Interface Cable Pin Connections (Option cable) ..... 2-11
  - 2.4.3 SIO Interface Cable Pin Connections ..... 2-12
  - 2.4.4 USB Interface Cable Pin Connections ..... 2-12
- 2.5 Names and Functions of FP Parts ..... 2-13**



# Preface

<b>2.6</b>	<b>FP Dimensions</b> .....	<b>2-14</b>
2.6.1	FP3700-T41 External Dimensions .....	2-14
2.6.2	FP3700-T41 External Dimensions (with Installation Fasteners) .....	2-15
2.6.3	Installation Fasteners .....	2-16
2.6.4	FP Installation Dimensions .....	2-16

## CHAPTER 3 INSTALLATION AND WIRING

<b>3.1</b>	<b>Installation</b> .....	<b>3-1</b>
3.1.1	Installation Procedures .....	3-1
<b>3.2</b>	<b>Wiring</b> .....	<b>3-6</b>
3.2.1	Power Cord Connection .....	3-6
3.2.2	Power Cable Connection .....	3-7
3.2.3	Connecting the Power Supply .....	3-8
3.2.4	Precautions: Grounding .....	3-9
3.2.5	Precautions: Input/Output Signal Lines .....	3-9
<b>3.3</b>	<b>Operation Mode Setup and Display Positioning</b> .....	<b>3-10</b>
3.3.1	Preset Settings and Adjustments for Dip Switch Operation .....	3-10
3.3.2	Status of Front LED in Operation Modes .....	3-12
3.3.3	Calibration of OSD Display Position .....	3-12

## CHAPTER 4 TOUCH PANEL DATA

<b>4.1</b>	<b>Touch Interface Data</b> .....	<b>4-1</b>
------------	-----------------------------------	------------

## CHAPTER 5 TROUBLESHOOTING

<b>5.1</b>	<b>Troubleshooting</b> .....	<b>5-1</b>
5.1.1	Possible Device Problems .....	5-1
5.1.2	No Display .....	5-2
5.1.3	Touch Panel Does Not Respond .....	5-4
<b>5.2</b>	<b>Error Message</b> .....	<b>5-5</b>
5.2.1	Error Message List .....	5-5

## CHAPTER 6 MAINTENANCE

<b>6.1</b>	<b>Regular Cleaning</b> .....	<b>6-1</b>
6.1.1	Cleaning the Display .....	6-1
6.1.2	Installation Gasket Replacement .....	6-2
<b>6.2</b>	<b>Periodic Check Points</b> .....	<b>6-3</b>
<b>6.3</b>	<b>Backlight Replacement</b> .....	<b>6-4</b>

# Connecting the FP to a PC

The FP unit's analog interface is designed for standard VGA mode. The number of dots (pixels) displayed are as follows:

Size	H Sync. (kHz)	V Sync. (Hz)	Dot Clock (MHz)	Screen Resolution Expansion (H: Horizontal) (V: Vertical)	Display Resolution
640×400	24.827	56.000	21.053	×1.6 (H) ×1.92 (V)	1024×767
640×400	31.469	70.000	25.175		
640×480	31.469	59.992	25.175	×1.6	1024×768
640×480	37.500	75.000	31.500		
640×480	35.000	66.667	30.240		
720×400 <sup>*1</sup>	31.469	70.000	28.320	×1.42 (H) ×1.92 (V)	1023×767
800×600	37.879	60.317	40.000	×1.28	1024×768
800×600	46.875	75.000	49.500		
1024×768	48.363	60.004	65.000	×1.0	1024×768
1024×768	56.476	70.069	75.000		
1024×768	60.023	75.029	78.750		

*\*1 When you use this resolution, select "720 x 400 Display Resolution 720 x 400 DSP" in the OSD (On Screen Display) system setting.*



- **When a signal timing value not compatible with this device is entered, or if the entered timing is larger than can be displayed by the dot clock, an "OUT OF RANGE" message is displayed. If this occurs, be sure to read your computer's manual and enter a value that is compatible with this device.**
- **If no signal (synchronized signal) is entered, a "NO SIGNAL" message is displayed.**

Some types of VGA equipment may not be within the ranges specified above, and, therefore, cannot be connected to the FP.

Also, if you change your PC's VGA board, there is the possibility that the new board may not be able to be connected to the FP.

# FP3700-T41 Features

---

## ■ High Quality TFT Color LCD Display

This unit is equipped with a 15.0 inch TFT type color LCD. Its superior brightness and wide viewing angle, not found in ordinary laptop-type TFT LCDs, widens your scope of applications.

The screen's maximum resolution is 1024 X 768 pixels and can display 1,677 colors.

## ■ Easy Installation In User's Cabinets and Panels

The FP3700-T41's slim and compact design makes installation a snap since it was designed specifically for use as an IA (Industrial Automation) or OA (Office Automation) system monitor. The flat, front panel provides protection equivalent to the rigorous IP65f standard. Even without its optional protective cover the front panel is highly resistant to both water and dust.

## ■ Panel can be used as a VGA Display

Since the FP3700-T41 is equipped with an analog RGB interface and a DVI-D Interface, it can be connected to a PC and other, similar devices. (The PC's dot clock frequency, however, must be within the standard range.)

## ■ Easy-to-use Built-In Touch Panel

The FP3700-T41 unit's built-in touch panel is standard equipment, allowing touch panel data to be output to a host PC via input/output commands and an RS-232C cable or USB cable. This is perfect for systems requiring both touch panel operation and data monitoring.

# What is IP65f?

---

This unit's protection rating of IP65f is actually a composite code, consisting of the internationally recognized British "Ingress Protection" standard (BS EN 60529:1992) - "IP65", and the standard developed by the Japanese Electronics Manufacturer's Association (JEM) - "f". This code is used in this manual to identify a given product's degree of structural resistance to a variety of environmental elements and thus, prevent problems or accidents related to the inappropriate use of a product.

The individual meaning of each character of this code is explained below. This code indicates the degree of ingress protection provided from the front face of the GLC, and assumes that the GLC is securely mounted into a metal panel.

## **IP 6 5 f**

(1) (2) (3) (4)

(1) Designates the type of protection provided.

(2) Indicates the degree of protection provided to the human body by the unit, and the degree of protection provided by the unit's front face from particles/dust intrusion into the interior of the unit.

Here, "6" indicates that the unit is completely protected from dust intrusion.

(3) Indicates the degree of protection provided by the unit's front face from water intrusion into the interior of the unit.

Here, "5" indicates that the unit is protected from water intrusion from a direct water jet.

(4) Indicates the degree of protection provided by the unit's front face from oil particle intrusion into the interior of the unit.

Here, "f" indicates that the unit is completely protected from oil intrusion via either oil particles or oil splashes from any direction (to the front panel).

# Package Contents

---

The FP unit's packing box contains the items listed below. Please check to be sure each item is included and is not damaged.

■ **FP unit (FP3700-T41)**

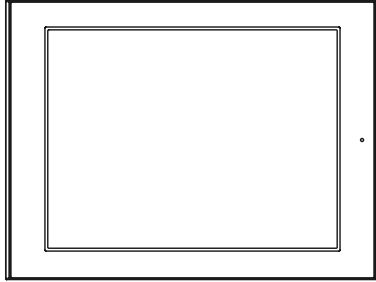

■ **FP3700 User Manual CD-ROM (1)**

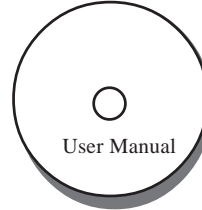

■ **Installation Gasket (1)**



■ **Installation Fasteners (8: 4 x 2 set)**

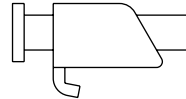

■ **FP3700-T41 Installation Guide (1)**



■ **AC Power Cord(1)**

■ **Cord Clamp(1)**

■ **USB Cable Strap(1)**



***The Power Cord included in the FP unit's package is designed only for AC100V or AC115V use. Any other voltage will require a different cord.***

These items have all been carefully packed with special attention to product quality. However, should you find anything damaged or missing, please contact your local FP distributor immediately for prompt service.

# UL/c-UL (CSA) Application

---

The FP3700-T41 is a UL/c-UL (CSA) listed product. (UL File No.E220851)

This unit conforms as a product to the following standards:

- **UL508** Industrial Control Equipment
- **CAN/CSA-C22.2, No.14-M1995** Industrial Control Equipment

## **FP3700-T41 (UL Registration Model: 3180040-01 )**

### <Cautions>

- The FP must be used as a built-in component of an end-use product.
- This unit should be installed in the front face of a metal panel.
- If this unit is installed so as to cool itself naturally, be sure to install it in a vertical panel.

Also, be sure that the FP unit is mounted at least 100 mm away from any adjacent structures or equipment. If these requirements are not met, the heat generated by the FP unit's internal components may cause the unit to fail to meet UL/c-UL standard requirements.

# CE Marking

---

The FP3700-T41 is a CE marked product that conforms to EMC directives and Low Voltage directives EN55011 Class A, EN61000-6-2 and EN60950-1 First Edition.

\*For detailed CE marking information, please contact your local FP distributor.

### <Cautions>

- The FP must be used as a built-in component of an end-use product.
- The FP is intended for indoor use only.
- This FP should be installed in the front face of a metal panel.
- If this unit is installed so as to cool itself naturally, be sure to install it in a vertical panel.

Also, be sure that the FP unit is mounted at least 100 mm away from any adjacent structures or equipment. If these requirements are not met, the heat generated by the FP unit's internal components may cause the unit to fail to meet standard requirements.

- When an end-user product will include the FP, be sure to design the FP unit's power cut-off switch as a separate disconnect device and locate it where the operator can easily reach it.
- Be sure the unit the FP is built into uses an EN60950-1 approved structure.

# *Memo*

# Chapter 1

## Introduction

1. System Design
2. Optional Equipment

### 1.1 System Design

The FP can be connected to Pro-face's PS-2000B or to a Windows® compatible PC.

FP3700-T41 unit

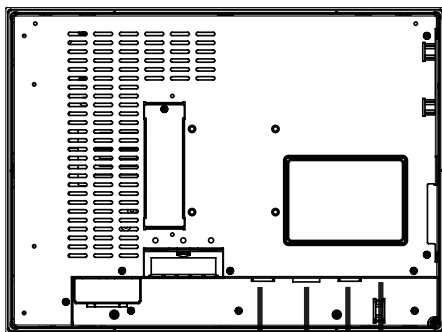

- USB Interface Cable (FP-US00) (A-B type Cable<5m>)  
For Touch data and Command transmission
- RS-232C Interface Cable (FP61V-IS00-O<5m>)  
Straight Cable : Dsub 9-pin female  
For Touch data and Command transmission
- DVI-D Cable (FP-DV01-50<5m>, FP-DV01-100<10m>)  
(XGA standard: DVI-D 24-pin)  
For image signal output  
\* The FP-DV01-100 can be used only when connected to a PS-2000B unit.
- Analog RGB Interface Cable (FP-CV02-45<4.5m>)  
XGA standard : Dsub 15-pin male  
For image signal output

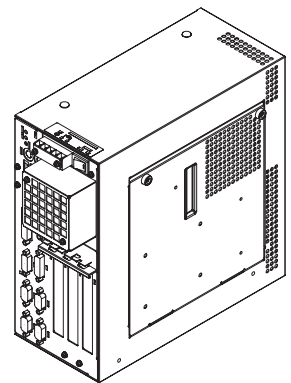

PS-2000B or Windows® compatible PC

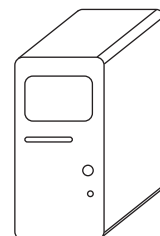

**Note:** The FP unit's dip switches set the type of cable(s) used for sending touch data and commands (USB or RS232C), and also for outputting image signals (DVI-D or Analog RGB).

**Reference** 3.3 Operation Mode Setup and Display Positioning



# 1.2 Optional Equipment

---

All optional items listed below are products of Digital Electronics Corporation.

Item	Model	Description
RS-232C Cable	FP61V-IS00-O	Serial interface cable (5m) used for touch panel data transmission between the host and the FP or command transmission to the FP. This is a straight Dsub9 pin female cable.
Analog RGB Cable	FP-CV02-45	Analog RGB interface cable when image signal is output to the FP from the host. VGA specifications (Dsub15 pin male). (4.5m)
USB Cable	FP-US00	USB interface cable (5m) used for touch panel data transmission between the host and the FP or command transmission to the FP. A-B type cable.
DVI-D Cable	FP-DV01-50 FP-DV01-100* <sup>2</sup>	Digital Visual Interface cable used to send the image signal from the host to the FP. XGA specifications (DVI-D 24-pin male). (5 m or 10 m)
Installation Fasteners	CA3-ATFALL-01	Metal installation fasteners.
Rubber Gasket	CA3-WPG15-01	Replacement rubber gasket, used when installing the FP. Same as the FP's original gasket.
Screen Protection Sheet	CA3-DFS15-01	Disposable and dirt resistant sheet for the FP's screen. The FP's touch panel can be used with this cover sheet attached. (5 sheets/set)
Backlight	CA3-BLU15-01	Replacement backlight for the FP.
Mouse Emulator V2 * <sup>1</sup>	PL-TD000	Mouse Emulator software for the FP.

\*1 OS can be Windows®95, WindowsNT®4.0, Windows®98, Windows®2000 or Windows®XP .

\*2 The FP-DV01-100 can be used only when connected to a PS-2000B unit. When using the FP-DV01-100, be sure to turn the PS-2000B's internal dipswitch 4 ON. (When using the FP-DV01-50, turn this switch OFF.)



**When you use the PL-TD000, hardware settings can not be automatically detected.**

**As a result, select the COM Port on your PC used to connect the FP unit and enter the settings given in the FP manual for the Allocated I/O address and Interrupt.**

# Chapter 2

## Specifications

### 2.1 General Specifications

1. General Specifications
2. Functional Specifications
3. Interface Specifications
4. Cable Diagrams
5. Names and Functions of FP Parts
6. FP Dimensions

## 2.1 General Specifications

### 2.1.1 Electrical Specifications

<b>Rated Voltage</b>	AC 100V to AC 240V
<b>Rated Voltage Range</b>	AC 85V to AC 264V
<b>Rated Frequency</b>	50/60 Hz
<b>Rated Frequency Range</b>	47 Hz to 63 Hz
<b>Allowable Voltage Drop</b>	20ms or less
<b>Power Consumption</b>	120VA
<b>In-Rush Current</b>	30A or less
<b>Voltage Endurance</b>	AC1500V 20mA for 1 minute (between charging and FG terminals)
<b>Insulation Resistance</b>	10M $\Omega$ or higher at DC500V (between charging and FG terminals)

### 2.1.2 Environment Specifications

<b>Ambient Operating Temperature</b>	0°C to +50°C (the panel face should not incline more than 30°)
<b>Storage Temperature</b>	-10°C to +60°C
<b>Ambient Humidity</b>	30%RH to 90%RH (Non condensing, wet bulb temperature: 39°C or less)
<b>Air Purity (Dust)</b>	Free of corrosive gasses
<b>Pollution Degree</b>	Pollution Degree 2
<b>Corrosive Gasses</b>	Free of corrosive gasses
<b>Vibration Resistance</b>	10Hz to 25Hz 4.9m/s <sup>2</sup> X, Y, Z directions (30min.)
<b>Noise Immunity (via noise emulator)</b>	Noise Voltage: 1,500Vp-p Pulse Duration: 1 $\mu$ s, 500ns, 50ns Rise Time: 1ns
<b>Electrostatic Discharge Immunity</b>	4kV (complies with EN 61000-4-2 Level 3)

## 2.1 General Specifications

### 2.1.3 Structural Specifications

---

<b>Grounding</b>	100Ω or less, or your country's applicable standard
<b>Ratings</b> <sup>*1</sup> (For front panel of installed unit)	Equivalent to IP65f (JEM 1030)
<b>External Dimensions</b>	W395mm [15.55in] x H294mm [11.57in] x D60mm [2.36in]
<b>Weight</b>	7kg (15.4lb) or less
<b>Cooling Method</b>	Natural air circulation

- <sup>\*1</sup> *The front face of the FP unit, installed in a solid panel, has been tested using conditions equivalent to the standard shown in the specification . Even though the FP unit's level of resistance is equivalent to the standard, oils that should have no effect on the FP can possibly harm the unit. This can occur in areas where either vaporized oils are present, or where low viscosity cutting oils are allowed to adhere to the unit for long periods of time. If the FP's front face protection sheet peels off, these conditions can lead to the ingress of oil into the FP and separate protection measures are suggested. Also, if non-approved oils are present, it may cause deformation or corrosion of the front panel's plastic cover. Therefore, prior to installing the FP be sure to confirm the type of conditions that will be present in the FP's operating environment.*
- If the installation gasket is used for a long period of time, or if the unit and its gasket are removed from the panel, the original level of the protection cannot be guaranteed. To maintain the original protection level, you need to replace the installation gasket regularly.*

## 2.2 Functional Specifications

### 2.2.1 Performance

<b>Graphics</b>		XGA (1024 X 768)
<b>Display Unit</b>		15 inch TFT XGA
<b>Touch Panel I/F</b>	<b>Type</b>	Resistive Film (Analog)
	<b>Resolution</b>	1024 X 1024
	<b>Interface</b>	Serial Interface (RS-232C) USB Interface
<b>Video I/F</b>		Analog RGB Interface DVI-D Interface

### 2.2.2 Display

<b>Size</b>	38 cm (15 in.) (Meas. diagonally)
<b>Type</b>	TFT Active Matrix Color LCD
<b>Resolution</b>	1024 (H) X 768 (V) pixels (1pixel=R+G+B color bits)
<b>Dot Pitch</b>	0.297mm [0.01 in.] X 0.297mm [0.01 in.]
<b>Display colors</b>	16,777,216 colors (R/G/B eight bits each)
<b>Viewing Angles<sup>*1</sup></b>	160°(H)(TYP)/140°(V)(TYP)
<b>Brightness<sup>*2</sup></b>	220 cd/m <sup>2</sup> (TYP)
<b>Brightness Control</b>	Available
<b>Contrast Control</b>	Available (Analog RGB only)(when using analog RGB connection)
<b>Display area</b>	H 304.1 mm [11.97 in.] X V 228.1 mm [8.98 in.]
<b>Display Modes</b>	640X400,640X480,720X400,800X600,1024X768
<b>Backlight</b>	CCFL (Replaceable)
<b>Backlight Lifetime</b>	Backlight can be replaced by the user. 50,000 hours at an ambient temperature of 25°C <sup>*3</sup>

*\*1 Dividing a completely white screen's brightness value by a completely dark screen's brightness value yields a value greater than 10. This value is only for reference and not a guaranteed value.*

*\*2 The brightness at the central part of the screen when displaying a completely white screen. This value is only for reference and not a guaranteed value.*

*\*3 50% decreased brightness indicates the backlight needs to be replaced. This value is only for reference and not a guaranteed value.*

## 2.3 Interface Specifications

# 2.3 Interface Specifications

### 2.3.1 Analog RGB Interface

Input signal type	Analog RGB
Input signal characteristic	Image signal: analog RGB Synchronous signal: TTL level, negative true or positive true Scanning type: non-interlaced
Setting via OSD (On Screen Display)	CONTRAST BRIGHTNESS H-POS V-POS OSD H-POSITION PHASE BACKLIGHT DEFAULT (ALL CLEAR)

The number of dots (pixels) displayed are as follows:

Size	H Sync. (kHz)	V Sync. (Hz)	Dot Clock (MHz)	Screen Resolution Expansion (H: Horizontal) (V: Vertical)	Display Resolution
640×400	24.827	56.000	21.053	×1.6 (H)	1024×767
640×400	31.469	70.000	25.175	×1.92 (V)	
640×480	31.469	59.992	25.175	×1.6	1024×768
640×480	37.500	75.000	31.500		
640×480	35.000	66.667	30.240		
720×400 <sup>*1</sup>	31.469	70.000	28.320	×1.42 (H) ×1.92 (V)	1023×767
800×600	37.879	60.317	40.000	×1.28	1024×768
800×600	46.875	75.000	49.500		
1024×768	48.363	60.004	65.000	×1.0	1024×768
1024×768	56.476	70.069	75.000		
1024×768	60.023	75.029	78.750		

*\*1 When you use this resolution, select "720 x 400 Display Resolution 720 x 400 DSP" in the OSD (On Screen Display) system setting.*

## 2.3 Interface Specifications

### ■ Analog RGB Interface Pin Assignments and Signal Names

Pin No.	Signal Name	Condition	Pin Location
1	Analog R	R signal input	
2	Analog G	G signal input	
3	Analog B	B signal input	
4	Reserved	NC (spare for input)	
5	Digital grounding	Digital signal GND	
6	Return R	R signal GND	
7	Return G	G signal GND	
8	Return B	B signal GND	
9	Reserved	NC (spare for input)	
10	Digital grounding	Digital signal GND	
11	Reserved	NC (spare for input)	
12	Reserved	NC (spare for input)	
13	H. SYNC	Horizontal synchronous signal input	
14	V. SYNC	Vertical synchronous signal input	
15	Reserved	NC (spare for input)	

Connector: Mini Dsub 15 pin male

Connector set screw: Inch type (4-40)

Cable: RGB cable manufactured by Digital Electronics Corporation of Japan  
FP-CV02-45<4.5m> (VGA standard)



***If a cable other than the specified RGB cable is used, product performance cannot be guaranteed due to the possibility of noise interfering with the FP unit's operation.***

## 2.3 Interface Specifications

### 2.3.2 DVI-D Interface

Input signal type	DVI-D
Setting by OSD (On Screen Display)	H-POS V-POS BACKLIGHT DEFAULT (ALL CLEAR)

The number of dots (pixels) displayed are as follows:

Size	H Sync. (kHz)	V Sync. (Hz)	Dot Clock (MHz)	Screen Resolution Expansion (H: Horizontal) (V: Vertical)	Display Resolution
640×400	24.827	56.000	21.053	×1.6 (H)	1024×767
640×400	31.469	70.000	25.175	×1.92 (V)	
640×480	31.469	59.992	25.175	×1.6	1024×768
640×480	37.500	75.000	31.500		
640×480	35.000	66.667	30.240		
720×400 <sup>*1</sup>	31.469	70.000	28.320	×1.42 (H) ×1.92 (V)	1023×767
800×600	37.879	60.317	40.000	×1.28	1024×768
800×600	46.875	75.000	49.500		
1024×768	48.363	60.004	65.000	×1.0	1024×768
1024×768	56.476	70.069	75.000		
1024×768	60.023	75.029	78.750		

*\*1 When you use this resolution, select "720 x 400 Display Resolution 720 x 400 DSP" in the OSD (On Screen Display) system setting.*

## 2.3 Interface Specifications

### ■ DVI-D Interface Pin Assignments and Signal Names

Pin No.	Signal Name	Pin No.	Signal Name	Pin Location
1	TMDS DATA2-	13	NC	
2	TMDS DATA2+	14	NC	
3	TMDS DATA2/4 SHIELD	15	GND (+5V)	
4	NC	16	Hot Plug Detect	
5	NC	17	TMDS DATA0-	
6	DDC Clock	18	TMDS DATA0+	
7	DDC Data	19	TMDS DATA0/5 SHIELD	
8	NC	20	NC	
9	TMDS DATA1-	21	NC	
10	TMDS DATA1+	22	TMDS CLOCK SHIELD	
11	TMDS DATA1/3 SHIELD	23	TMDS CLOCK+	
12	NC	24	TMDS CLOCK-	

Connector: DVI-D 24-pin male

Connector set screw: Inch type (4-40)

Cable: DVI-D cable manufactured by Digital Electronics Corporation of Japan (FP-DV01-50 <5 m>, FP-DV01-100 <10 m>)



- ***If a cable other than the specified DVI-D cable is used, product performance cannot be guaranteed due to the possibility of noise interfering with the FP unit's operation.***
- ***The FP-DV01-100 can be used only when connected to a PS-2000B unit. When using the FP-DV01-100, be sure to turn the PS-2000B's internal dipswitch 4 ON.***  
***(When using the FP-DV01-50, turn this switch OFF.)***



## 2.3 Interface Specifications

### 2.3.3 RS-232C Interface

Serial Interface	Baud rate: 9600 bps
	Data length: 8 bits
	Parity: none
	Stop bit: 1

#### ■ RS-232C Interface Pin Assignments and Signal Names

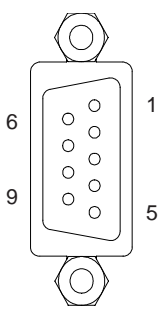
Pin No.	Signal Name	Condition	Pin Location
1	CD	Carrier Detect <sup>*1</sup>	
2	RD	Receive Data (FP->Host)	
3	SD	Send Data (FP<-Host)	
4	DTR	Data Terminal Ready <sup>*1</sup>	
5	GND	Ground	
6	DSR	Data Set Ready <sup>*1</sup>	
7	RS	Request to Send (FP<-Host)	
8	CS	Clear to Send (FP->Host)	
9	NC	(Used internally)	

Connector: Dsub 9 pin female

Connector set screw: Inch type (4-40)

Cable: SIO cable manufactured by Digital Electronics Corporation of Japan (FP61V-IS00-O)

*\*1 CD, DTR, and DSR are connected together inside of the FP.*



#### Note: Concerning Signal Names

Signal names used for the serial interface on FP units are designed to match the pin order used on most PC serial interfaces, so that a straight cable can be used to connect the two. **Therefore, connect each pin's signal to the same signal name on the PC side.**

For example, pin #2 'RD' should be connected to the 'RD' input terminal on the PC's connector.

Refer to section "2.4 Cable Diagrams" for each signal's direction.



***If a cable other than the specified RS-232C cable is used, product performance cannot be guaranteed due to the possibility of noise interfering with the FP unit's operation.***

### 2.3.4 USB Interface

#### ■ USB Interface Pin Assignments and Signal Names

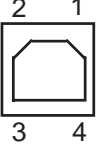
Pin NO.	Signal Name	Condition	Pin Location
1	USB1-5V	+5VIN	
2	USBD1(-)	USBdata(-)	
3	USBD1(+)	USBdata(+)	
4	GND	Ground	

Communication: Low speed Device

Connector: B type connector

Cable: USB cable manufactured by Digital Electronics Corporation of Japan (FP-US00)



***If a cable other than the specified USB cable is used, product performance cannot be guaranteed due to the possibility of noise interfering with the FP unit's operation.***

## 2.4 Cable Diagrams

# 2.4 Cable Diagrams

### 2.4.1 RGB Interface Cable Pin Connections (Option cable: VGA standard)

FP			RGB cable			PC			
1	Analog R	Input	1	RED IN	RED VIDEO	1	Output	RED VIDEO	1
2	Analog G	Input	2	GRIN IN	GRN VIDEO	2	Output	GRN VIDEO	2
3	Analog B	Input	3	BLU IN	BLU VIDEO	3	Output	BLU VIDEO	3
4	Reserved	--	4	NC	NC	4	--	NC	4
5	Digital ground	--	5	GND	GROUND	5	--	GROUND	5
6	Return R	--	6	RED GND	GROUND RED	6	--	GROUND RED	6
7	Return G	--	7	GRN GND	GROUND GRN	7	--	GROUND GRN	7
8	Return B	--	8	BLU GND	GROUND BLU	8	--	GROUND BLU	8
9	Reserved	--	9	NC	NC	9	--	NC	9
10	Digital ground	--	10	GND	GROUND	10	--	GROUND	10
11	Reserved	--	11	NC	MONITOR SENSE(COLOR)	11	--	MONITOR SENSE(COLOR)	11
12	Reserved	--	12	NC	MONITOR SENSE(MONO)	12	--	MONITOR SENSE(MONO)	12
13	H.SYNC	Input	13	HSYN	HSYN	13	Output	HSYN	13
14	V.SYNC	Input	14	VSYN	VSYN	14	Output	VSYN	14
15	Reserved	--	15	NC	NC	15	--	NC	15
FG	FG	--	FG	FG	FG	FG	FG		

Signals and signal names used with the FP and the RGB cable (optional cable) are the same as those used for PCs. Also, the same pin is used on both sides of the optional cable so that you can connect the cable regardless of the cable direction.

Inch is used for the pitch of the connector screw on the PC. For this reason, inch (4-40) is also used for the pitch of the connector screw for the cable and the FP.

# 2.4 Cable Diagrams

## 2.4.2 DVI-D Interface Cable Pin Connections (Option cable)

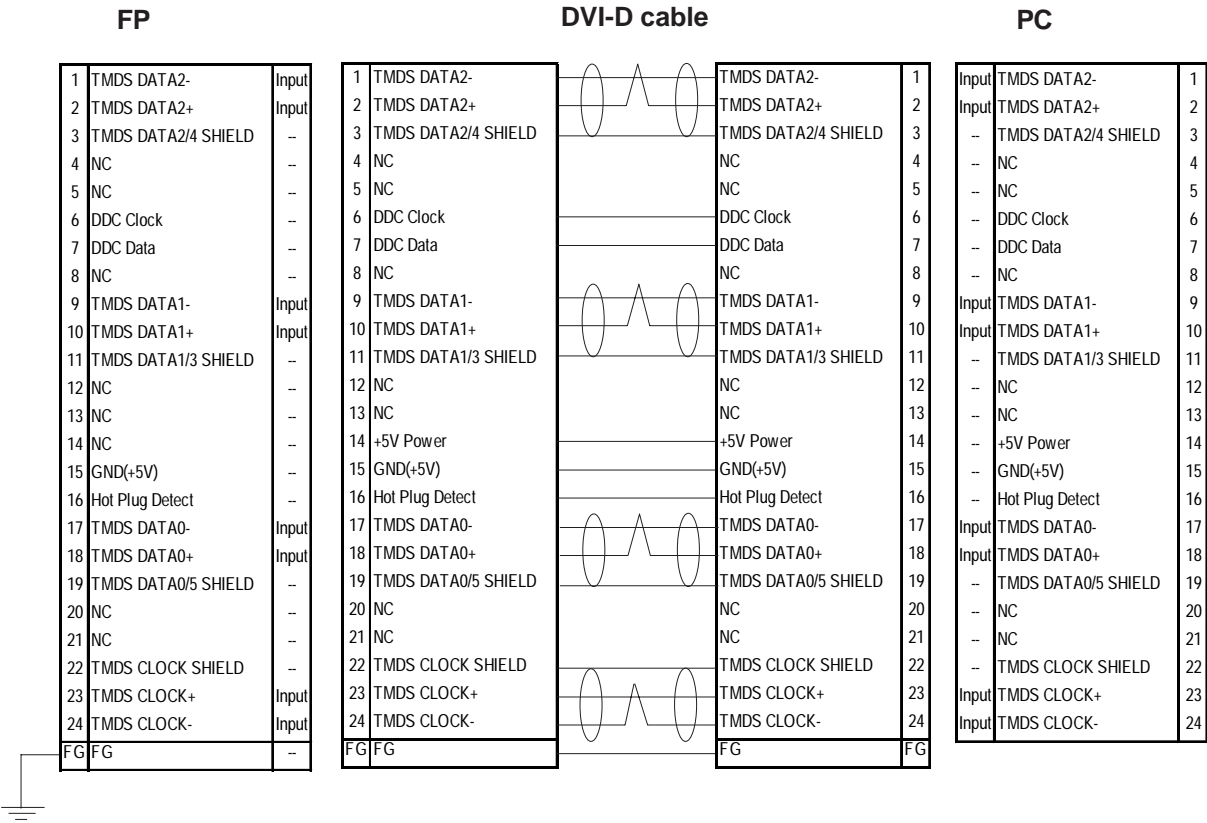

Signals and signal names used with the FP and the DVI-D cable (optional cable) are the same as those used for PCs. Also, the same pin is used on both sides of the optional cable so that you can connect the cable regardless of the cable direction.

Inch is used for the pitch of the connector screw on the PC. For this reason, inch (4-40) is also used for the pitch of the connector screw for the cable and the FP.



**Note:** The FP-DV01-100 cable's 6, 7, 14 and 15 pins are not connected.

## 2.4 Cable Diagrams

### 2.4.3 SIO Interface Cable Pin Connections

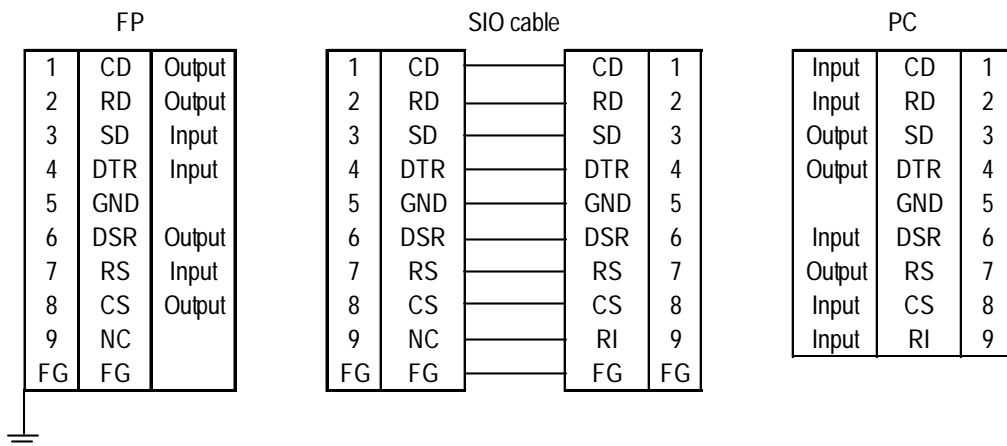

Signals and signal names used with the FP and the SIO cable (optional cable) are the same as those used for PCs. Also, the same pin is used on both sides of the optional cable so that you can connect the cable regardless of the cable direction.

Inch is used for the pitch of the connector screw on the PC. For this reason, inch (4-40) is also used for the pitch of the connector screw for the cable and the FP.

### 2.4.4 USB Interface Cable Pin Connections

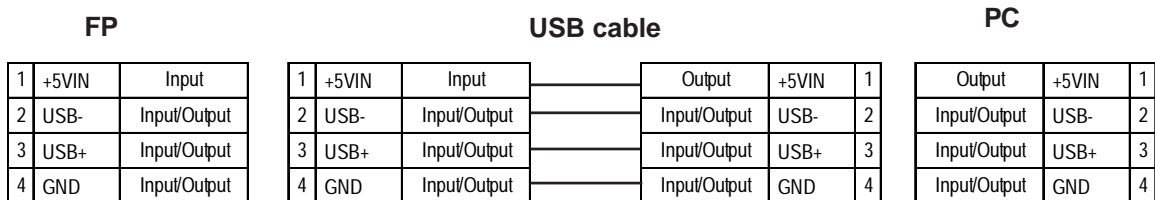

# 2.5 Names and Functions of FP Parts

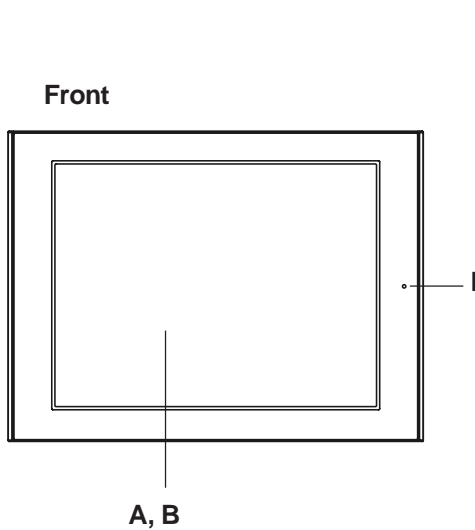

**A: TFT Color LCD**

The display monitor for your host unit.

**B: Touch Panel**

Allows you to switch screens or write data to the host.

**C: AC Connector**

Provides the input and ground terminals for a power cable.

**D: Setting Switch (Dip switch)**

Used to change the settings of each operation mode.

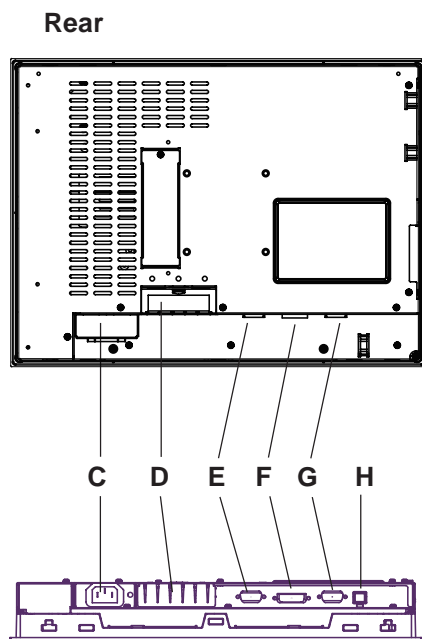

**E: VGA Interface (analog RGB) Connector**

Connector for analog RGB interface

**F: DVI-D Interface Connector**

Connector for DVI-D interface

**G: RS-232C Connector**

Connector for RS-232C (serial) interface. Used for both sending touch panel data to the host, and receiving commands from the host.

**H: USB Connector**

Connector for USB interface. Used for both sending touch panel data to the host, and receiving commands from the host.

Bottom

**I: Front LED**

Used to indicate the condition of the power supply, a backlight burnout or image signal input.

**Reference** 3.3.2 Status of Front LED in Operation Modes

## 2.6 FP Dimensions

# 2.6 FP Dimensions

---

### 2.6.1 FP3700-T41 External Dimensions

---

Unit: mm [in.]

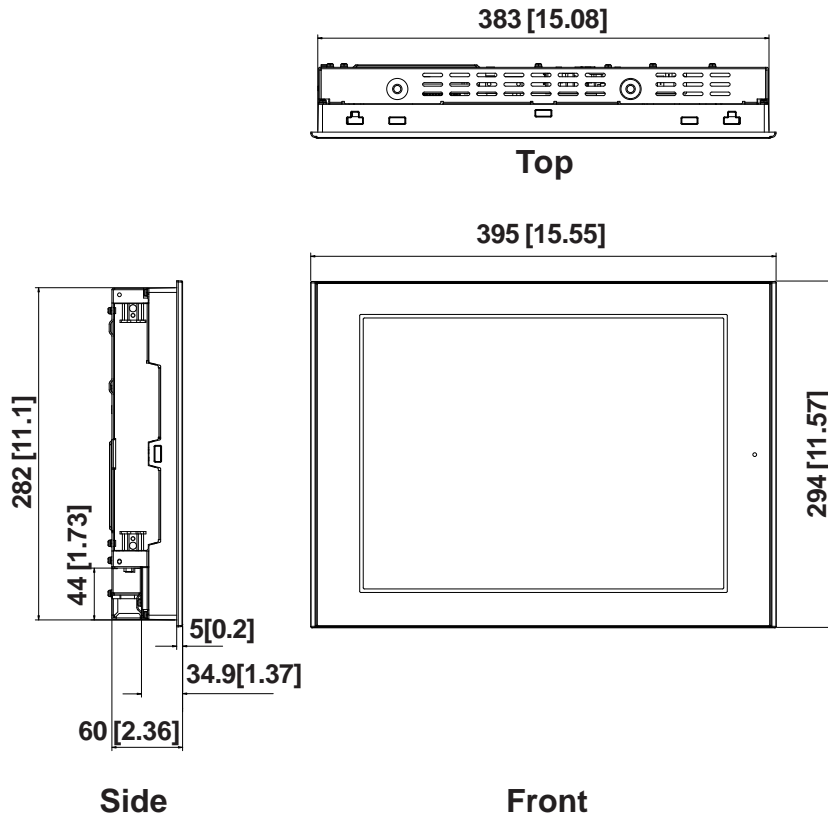

# 2.6 FP Dimensions

## 2.6.2 FP3700-T41 External Dimensions (with Installation Fasteners)

Unit: mm [in.]

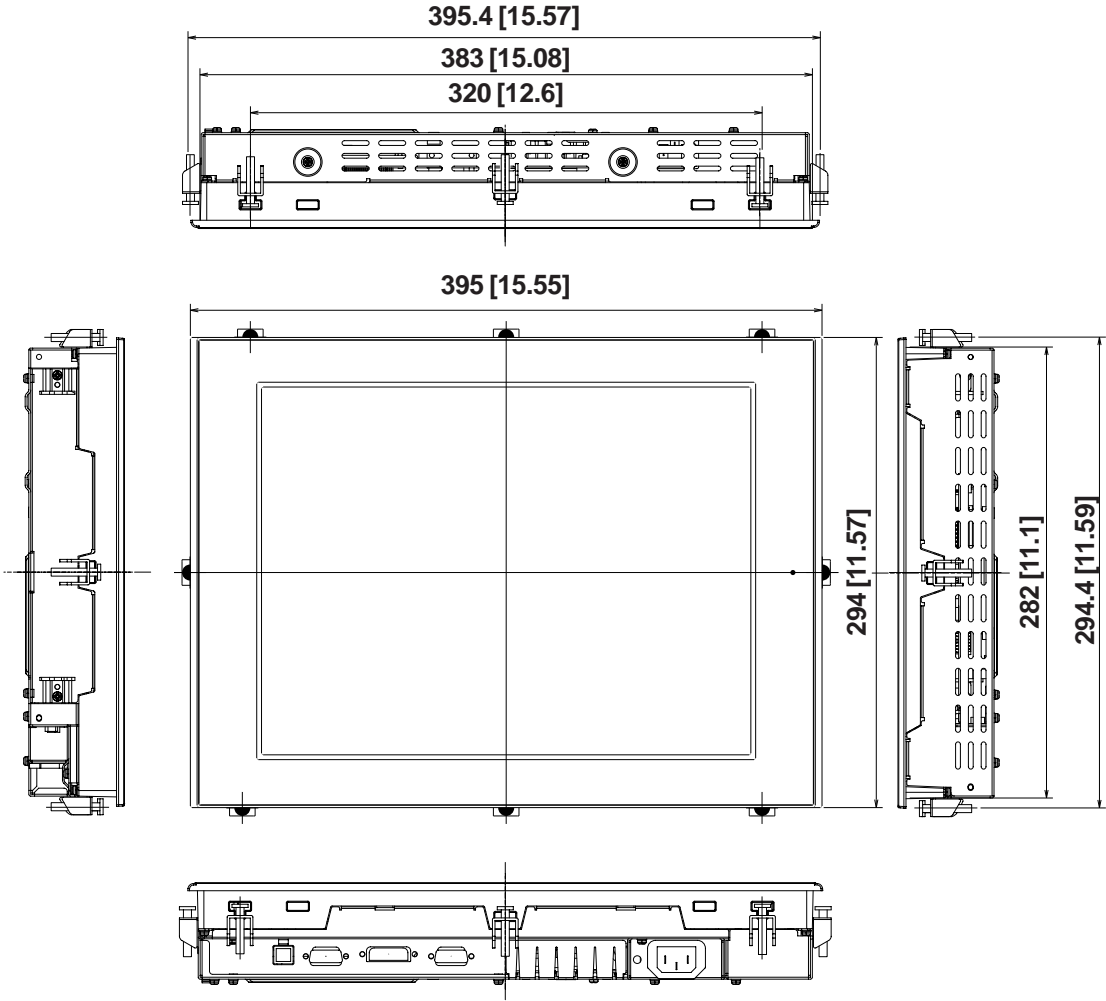



## 2.6 FP Dimensions

### 2.6.3 Installation Fasteners

Unit: mm [in.]

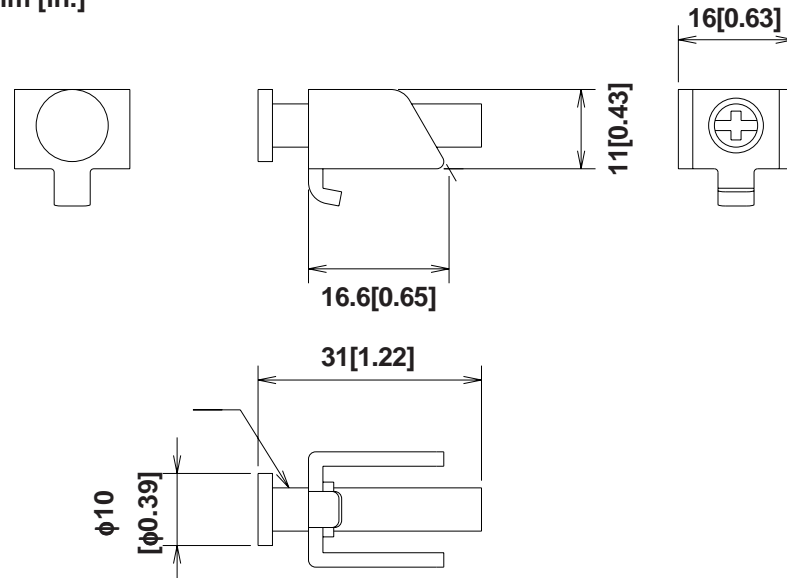

### 2.6.4 FP Installation Dimensions

Unit: mm [in.]

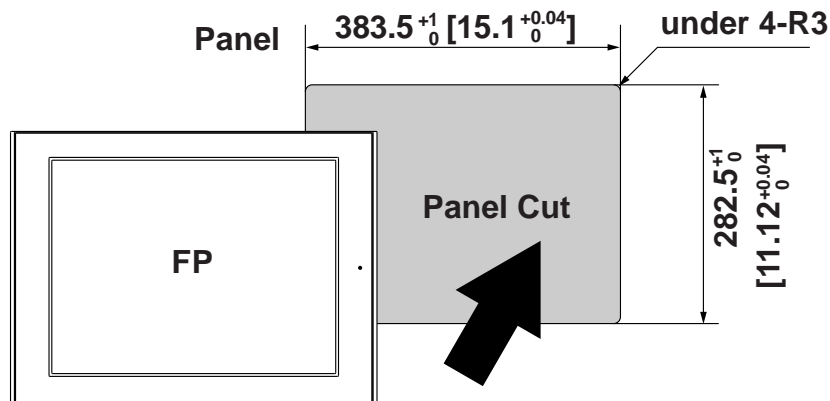

- Panel thickness should be between 1.6mm [0.06in.] and 10mm [0.4in.]. Decide the panel's thickness based on the level of panel strength required.
- Check that the installation panel or cabinet's surface is flat, in good condition and has no jagged edges.
- If desired, metal reinforcing strips can be attached to the inside of the panel, near the Panel Cut, to increase the panel's strength.  
    **Reference** 2.1.3 Structural Specifications
- Create the correct sized opening required to install the FP, using the installation dimensions given.

# Chapter 3

## Installation and Wiring

1. Installation
2. Wiring
3. Operation Mode Setup and Display Positioning

### 3.1 Installation

---

#### 3.1.1 Installation Procedures

---

Follow the steps given below when installing the FP.

##### ■ Check the Installation Gasket's Seating

It is strongly recommended that you use the installation gasket, since it absorbs vibration in addition to repelling water.

Place the FP on a level surface with the display panel facing downward. Check that the FP's installation gasket is seated securely into the gasket's groove, which runs around the perimeter of the panel's frame.

For details about installing the gasket, refer to

**Reference** *6.1.2 Installation Gasket Check/Replacement*



- **Before installing the FP into a cabinet or panel, check that the installation gasket is securely attached to the unit.**
- **A gasket which has been used for a long period of time may have scratches or dirt on it, and can lose much of its dust and drip resistance. Be sure to change the gasket periodically (or when scratches or dirt become visible).**
- **Be sure to use gasket model CA3-WPG15-01.**
- **Be sure the gasket's seam is not inserted into any of the unit's corners, only in the straight sections of the groove. Inserting it into a corner may lead to its eventually tearing.**
- **To ensure the installation gasket's maximum level of moisture resistance, be sure the gasket's seam is inserted as shown into the panel's bottom face.**

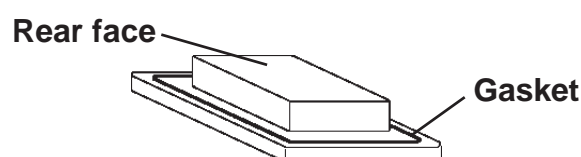

# 3.1 Installation

## ■ Creating a Panel Cut

Create the correct sized opening required to install the FP, using the installation dimensions given.

**Reference** 2.6.4 FP Installation Dimensions

The installation gasket, installation fasteners and attachment screws are all required when installing the FP.

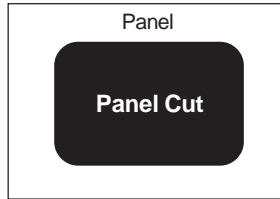

**Note:** Check that the installation panel or cabinet's surface is flat, in good condition and has no jagged edges. Also, if desired, metal reinforcing strips can be attached to the inside of the panel, near the Panel Cut, to increase the panel's strength.



**Panel thickness should be from 1.6mm [0.06in.] to 10mm [0.4in.]. Decide the panel's thickness based on the level of panel strength required.**

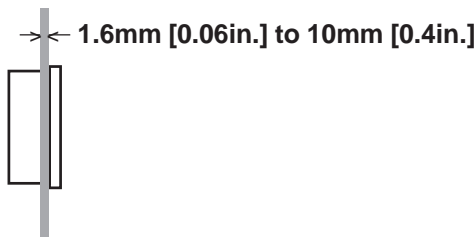

**For easier maintenance, operation, and improved ventilation, be sure to install the FP at least 100 mm [3.94 in.] away from adjacent structures and other equipment.**

Unit: mm  
[in.]

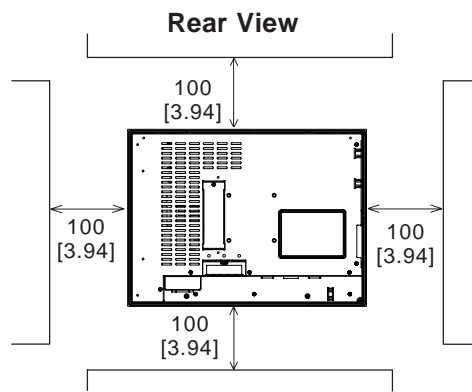
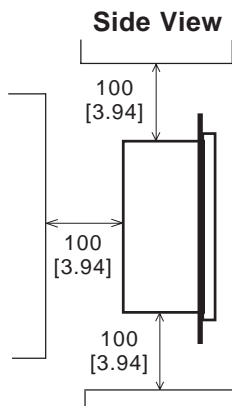

## 3.1 Installation



- **Be sure that the ambient temperature and the ambient humidity are within their designated ranges. (When installing the FP in a cabinet or enclosure, the term “ambient temperature” indicates the cabinet or enclosure’s internal temperature.)**

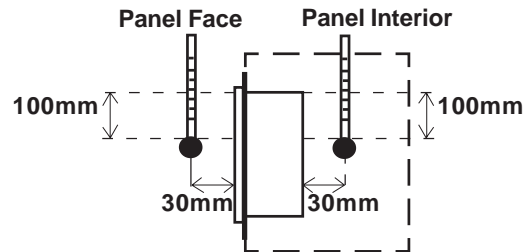

Operating temperature: 0 to 50°C

- **Be sure that heat from surrounding equipment does not cause the FP to exceed its standard operating temperature.**
- **When installing the FP in a slanted panel, the panel face should not incline more than 30°.**

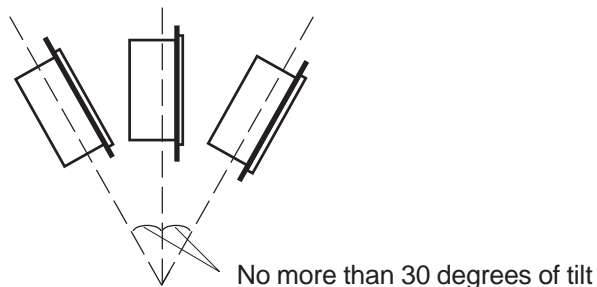

- **When installing the FP in a slanted panel, and the panel face inclines more than 30°, the ambient temperature must not exceed 40 °C. You may need to use forced air cooling (fan, A/C) to ensure the ambient operating temperature is 40 °C or below.**
- **When installing the FP vertically, position the unit so that the AC Connector is also vertical.**

## 3.1 Installation

### ■ Installing the FP

- 1) Insert the FP into the panel cut, as shown here.

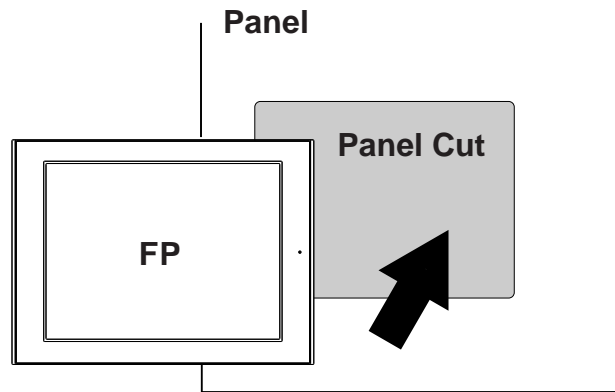

- 2) Insert the installation fasteners into the FP's insertion slots, at the top and bottom of the unit. (total: 8 slots)

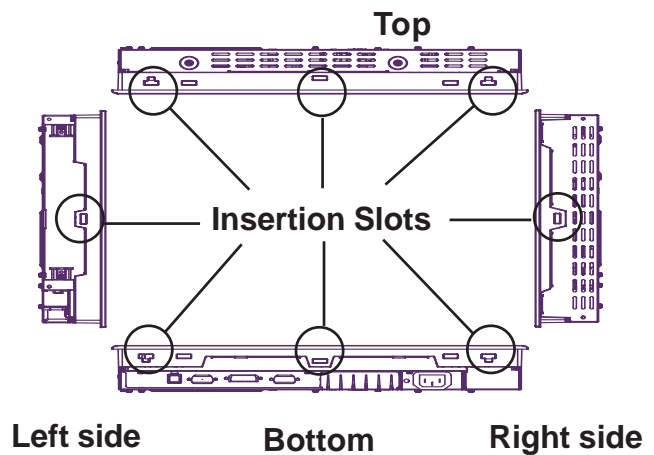

- 3) Insert each of the fasteners as shown below. Be sure to pull the fastener back until it is flush with the rear of the attachment hole.

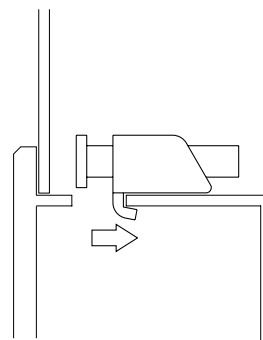
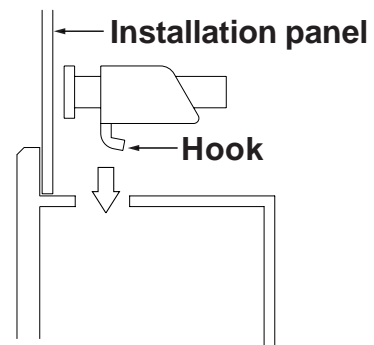

## 3.1 Installation

- 4) Use a Phillips screw driver to tighten each fastener screw and secure the FP in place.

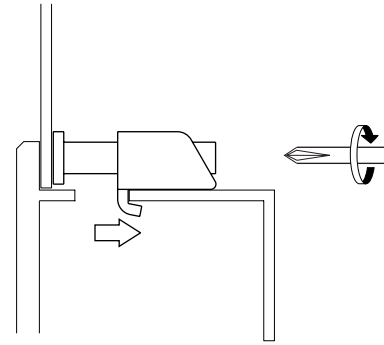

**Do not use too much force, since it may damage the FP unit. A torque of only 0.5 N•m is sufficient to tighten these screws.**

# 3.2 Wiring

## 3.2.1 Power Cord Connection



### WARNINGS

- To avoid an electric shock, when connecting the FP's power cord terminals to the power terminal block, confirm that the FP's power supply is completely turned OFF, via a breaker, or similar unit.
- To avoid the dangers of fire, electric hazards and equipment damage, be sure to use only the specified voltage when operating the FP.
- Since there is no power switch on the FP unit, be sure to attach a breaker-type switch to its power cord.

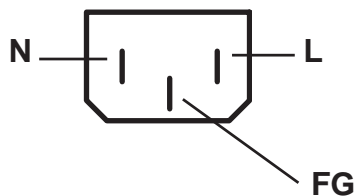

AC Connector\*1

- \*1 L : AC Input Terminal-live line  
N : AC Input Terminal-neutral line  
FG : Ground Terminal connected to the FP chassis



**The Power Cord included in the FP unit's package is designed only for AC100V or AC115V use. Any other voltage will require a different cord.**



### Attaching the AC Power Cord

- 1) Open the AC Power Cord Clamp and insert the AC Power Cord as shown in fig. 1. Then, close the Cord Clamp until it clicks into place and locks around the AC Power Cord Collar.

**The Cord Clamp has four teeth for locking. These are to adjust the amount of grip used to hold the AC Power Cord Collar.**

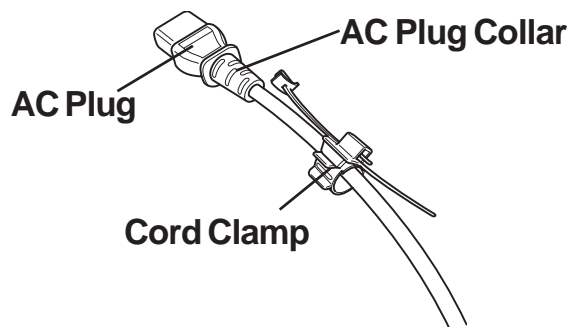
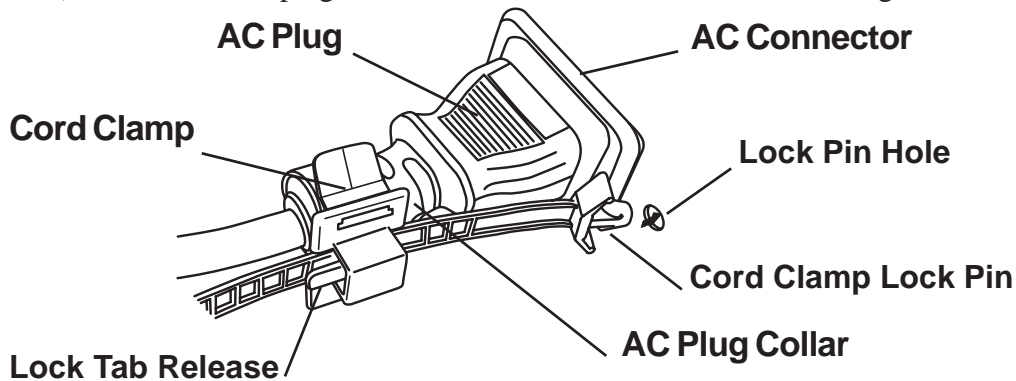

Figure 1

2) Connect the AC plug to the FP unit's AC connector, as shown in fig. 2.



**Figure 2**

3) Insert the Cord Clamp Lock Pin into the FP unit's Lock Pin Hole.

4) Adjust the Lock Pin's Lock Tab length until it is securely held.

### ◆ Removing the AC Power Cord

5) While lifting up on the Lock Pin's Lock Tab Release, pull the AC Plug, Plug Collar and Cord Clamp backwards to disconnect it from the FP.

6) Open the Cord Clamp (opposite of step 1) and remove the AC Power Cord from the Cord Clamp.

### 3.2.2 Power Cable Connection

---

### ◆ USB Cable Strap Attachment Procedure

1) Connect the USB cable to the connector.

2) Insert the cable strap into the cable strap holder as shown in figure 1, and tighten the strap until the cable is secured in place.

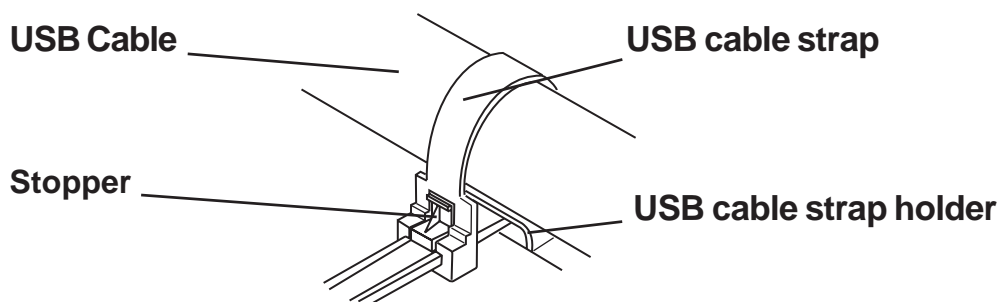

**Figure 1**

### ◆ USB Cable Strap Removal Feature

3) Push in the cable strap's stopper until the cable strap band is unlocked, then remove the band.

4) Disconnect the USB cable.



## 3.2 Wiring

### 3.2.3 Connecting the Power Supply

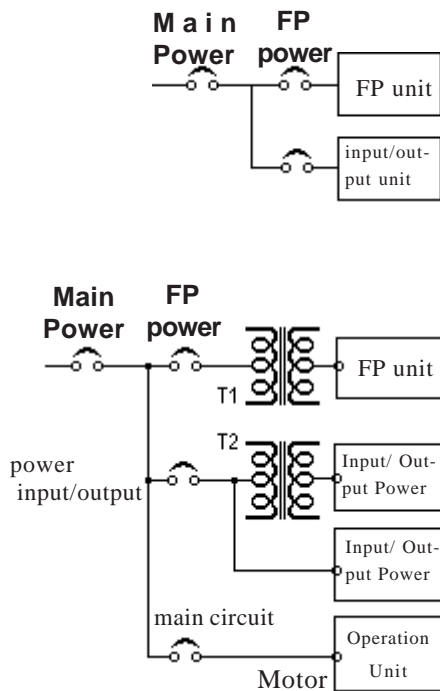

- When supplying power to the FP unit, please separate the input/output and operation unit lines, as shown.
- To increase the noise resistance quality of the power cable, simply twist each power wire before attaching the Ring Terminal.
- The power supply cable must not be bundled or positioned close to main circuit lines (high voltage, high current), or input/output signal lines.
- Connect a lightning surge absorber, as shown in the diagram, to deal with power surges.
- To avoid excess noise, make the power cable as short as possible.

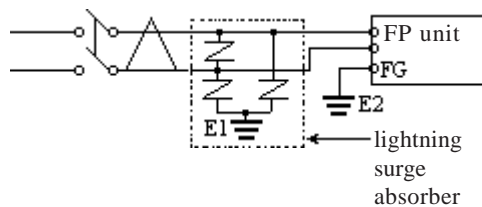

- **Be sure to ground the surge absorber (E1) separately from the FP unit (E2).**
- **Select a surge absorber that has a maximum circuit voltage greater than the power supply's peak voltage.**

### 3.2.4 Precautions: Grounding

---

#### (a) Exclusive grounding (BEST)

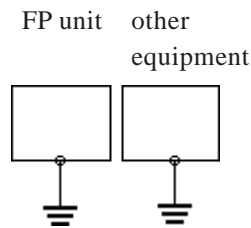

#### (b) Common grounding (OK)

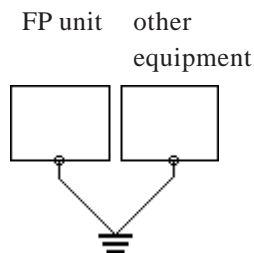

#### (c) Common grounding (BAD)

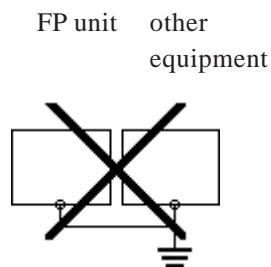

- Connect the FP's FG terminal to an exclusive ground. [diagram (a) - Grounding resistance of under 100Ω.]
- If exclusive grounding is not possible, use a common connection point. [diagram (b)]
- The grounding wire should have a cross sectional area greater than 2mm<sup>2</sup>. Make the connection point as close to the FP unit as possible, and make the wire as short as possible. When using a long grounding wire, replace the thin wire with a thicker wire placed in a duct.
- If this equipment does not function properly when grounded, disconnect the ground wire from the FG terminal.

### 3.2.5 Precautions: Input/Output Signal Lines

---

- Input and output signal lines must be separated from operating circuit power cables.
- If this is not possible, use a shielded cable and connect the shield to the FP chassis.

## 3.3 Operation Mode Setup and Display Positioning

# 3.3 Operation Mode Setup and Display Positioning

### 3.3.1 Preset Settings and Adjustments for Dip Switch Operation

The setup switches (Dip Switches) are located on the rear of the unit.

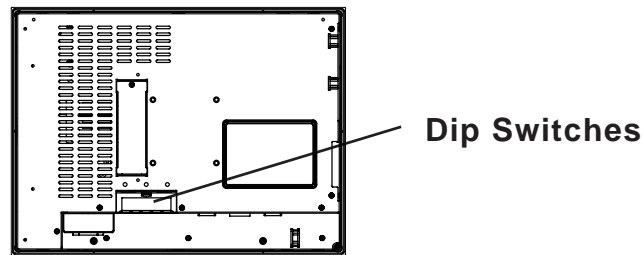

The FP unit's Dip Switches are preset as shown below. These settings are made on the assumption that a Windows® compatible computer is used.

#### ◆SW1

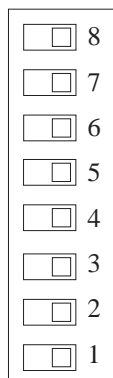

ON

SW1-8	Reserved (Set this switch to OFF)
SW1-7	Reserved (Set this switch to OFF)
SW1-6	Reserved (Set this switch to OFF)
SW1-5	Switch between analog RGB and DVI-D input.
SW1-4	Reserved (Set this switch to OFF)
SW1-3	Reserved (Set this switch to OFF)
SW1-2	Display/hide the OSD
SW1-1	Switch between USB and RS232C for touch panel data transmission.

### 3.3 Operation Mode Setup and Display Positioning

- SW1-1

Dip Switch SW1-1 is used to switch the data input (command control) method on the touch panel between USB and RS-232C.

When the switch is set to OFF, data output and command input/output are performed via RS-232C. When the switch is set to ON, USB is used.

The default setting is OFF. (RS-232C)

- SW1-2

Dip Switch SW1-2 is used to display or hide the OSD.

To hide the OSD, set the switch to ON. To display the OSD, set the switch to OFF.

The default setting is OFF. (OSD is displayed.)

- SW1-5

Dip Switch SW1-5 is used to change the image input method.

When the switch is set to ON, DVI-D image input method is used. When the switch is set to OFF, the analog RGB image input method is used.

The default setting is OFF. (Analog RGB is used.)

## 3.3 Operation Mode Setup and Display Positioning

### 3.3.2 Status of Front LED in Operation Modes

LED	OFF	Green	Orange	Green/ Red Flash	Orange Flash
Panel	Power OFF	Power ON	Power ON	Power ON	Power ON
Backlight	-	Normal	Normal	Burned-out	Burned-out
Input of Image	-	Yes	No	Yes	No

### 3.3.3 Calibration of OSD Display Position

You can operate the FP screen menus via the touch panel, and adjust screen image display to a minute level. The feature is called OSD (On Screen Display).

#### (1) How to start the OSD

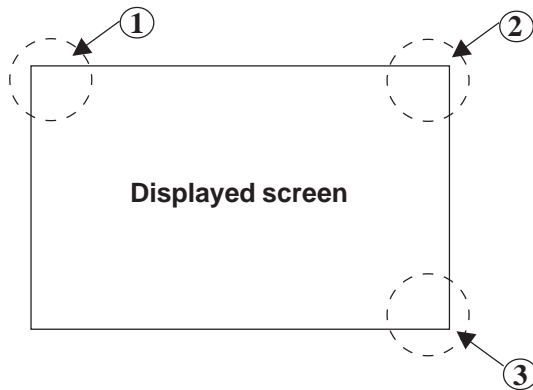

#### ■ Starting the OSD

To start the OSD and enter OSD mode, press the three corners of the touch panel in the following order (upper left (1) a upper right (2) a lower right (3)) within 5 seconds. In OSD mode, the setting screen is displayed in the center of the screen. In this mode, the touch panel cannot be used to export data to external devices unless the settings for the OSD are completed.



**Note:** OSD is not displayed when a SW 1-2 is ON.

#### (2) Main Menu



“V\*\*\*” indicates the version of the OSD.

#### ■ Using the OSD









Icons on the screen are used to operate the OSD. When you start up the OSD, the top menu displays. Touching the icon of the item you want to adjust displays its submenu or setting change screen. In the setting change screen, ◀ and ▶ icons are used to change the setting. To apply the setting, press the **SET** button. Press the **SAVE** button to save the defined settings.

#### ■ Quitting the OSD

To quit the OSD, press the ESC button in the top menu or leave the OSD as it is for at least 30 seconds. If the OSD is automatically closed after 30 seconds of inactivity, the values set before the OSD was closed will be applied.

### 3.3 Operation Mode Setup and Display Positioning

#### (3) Characters and their functions

Item		Function
	CONTRAST	Adjusts the contrast. (Analog RGB only) <sup>*1</sup>
	BLACK LEVEL	Adjusts the color brightness. (Analog RGB only) <sup>*1</sup>
	H-POS	Adjusts the horizontal position of the screen.
	V-POS	Adjusts the vertical position of the screen.
	OSDH-POSITION	Adjusts the screen size in the horizontal direction. (Analog RGB only) <sup>*1</sup>
	PHASE	Adjusts the input signal and the dot clock position. (32 levels) (Analog RGB only) <sup>*1</sup>
<b>DIM</b>	BACKLIGHT	Adjusts the backlight brightness. (9 levels)
<b>AGC</b>	AUTO GAIN	Automatically adjusts the contrast and the brightness. (Analog RGB only) <sup>*1</sup>
<b>DSP</b>	DISPLAY MODE	Displays the resolution of the input image data.
<b>RST</b>	OSD CLEAR (RESET)	Resets the current OSD value to the default value.
<b>SAVE</b>	OSD SAVE	Save the current value and quit the OSD.
	SYSTEM	Changes settings such as activating the click sound.
	ESCAPE	Cancels the setting and returns to the upper level. In the main menu, this command closes the OSD.

*\*1 When using DVI-D, the message "DO NOT NEED SETUP DVI-D" is display and no settings are required.*

## 3.3 Operation Mode Setup and Display Positioning

### ■ Main menu

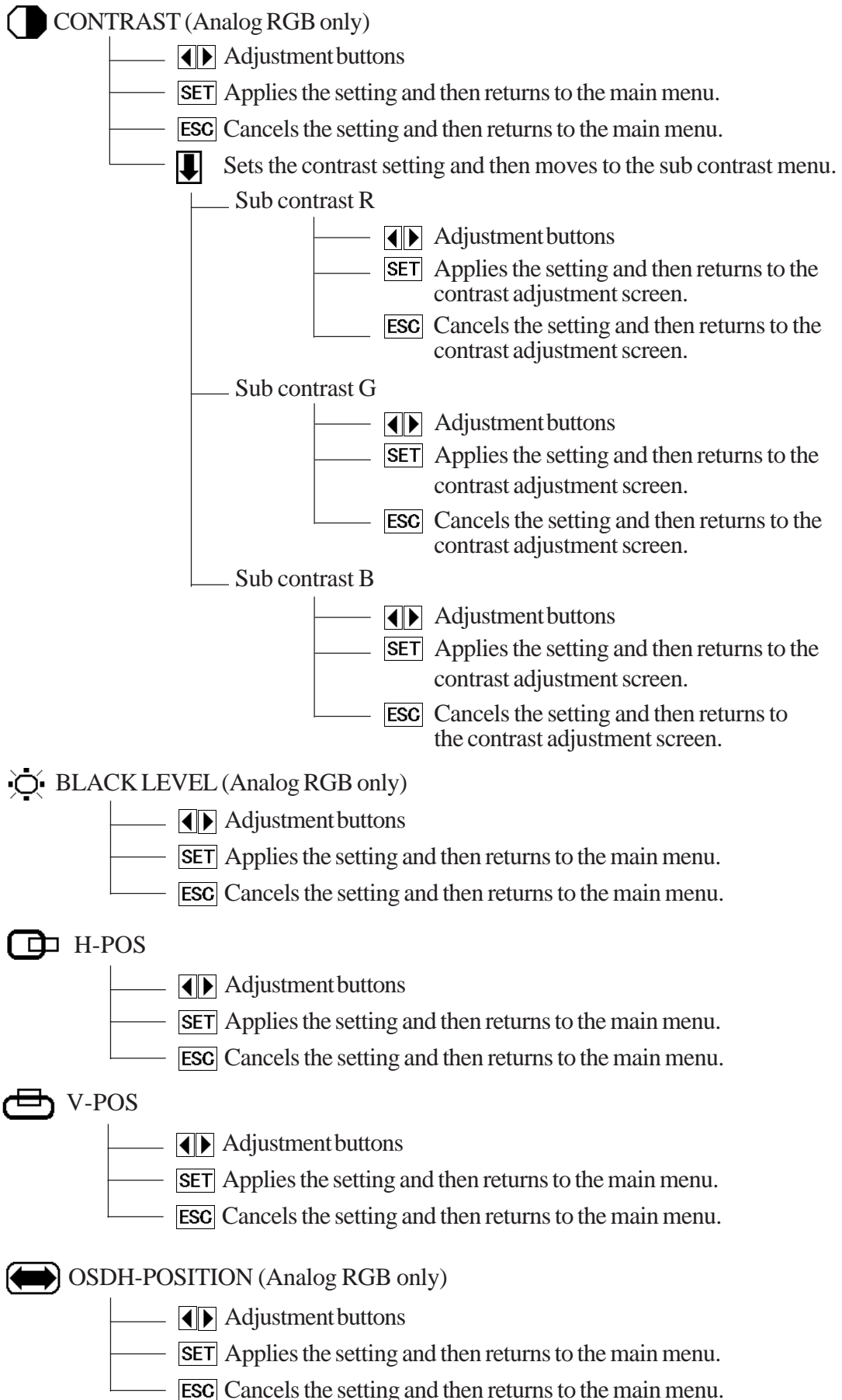

### 3.3 Operation Mode Setup and Display Positioning



PHASE (Analog RGB only)

- Adjustment buttons
- Applies the setting and then returns to the main menu.
- Cancels the setting and then returns to the main menu.

#### **DIM** BACKLIGHT

- Adjustment buttons
- Applies the setting and then returns to the main menu.
- Cancels the setting and then returns to the main menu.

#### **AGC** AUTO GAIN (Analog RGB only)

- Starts the auto gain control and then automatically returns to the main menu.



**Be sure to perform the auto gain control when the screen has both 100% black and 100% white areas displayed.**

#### **DSP** DISPLAY MODE

- Returns to the main menu.

#### **RST** OSD CLEAR

- Clears the setting.
- Cancels the setting and then returns to the main menu.

#### SYSTEM

- Enables/disables the click sound. With this parameter, the sound level can also be adjusted.  
(Default value: OFF <Click sound disabled>)
- When an input data resolution of 720 x 400 is used in the VGA text mode, set this parameter to ON. For other resolutions, set this parameter to OFF.  
(Default: OFF)



### 3.3 Operation Mode Setup and Display Positioning

<b>AUTO OFF DSP</b>	<p>Enables/disables the screen display Auto OFF function and sets the time when the Auto OFF function is enabled. (Default: OFF &lt;Auto OFF function disabled&gt;)</p> <p>The Auto OFF function automatically turns off the display to prevent the screen from burning out when the touch panel is not used for some period of time. With this parameter, you can set the time interval to turn off the screen display (how much time passes before the screen display is turned off) when the touch panel is not used. If the touch panel is not touched over the set time, the backlight will automatically turns off.</p> <p>Select the time period from 1 min, 3 min, 5 min, 10 min, and OFF (Auto OFF function disabled).</p>
<b>BL ALARM</b>	<p>Enables/disables the Backlight burnout detect function. (Default: ON )</p> <p>When a burned-out backlight is detected, the status LED flashes alternately green and red, or a steady orange.</p> <p>Touch-operation will be disabled when the backlight burns out, which prevents the FP from sending input signals to the PLC.</p> <p> Normally, the FP unit detects a backlight burnout by monitoring the backlight's current flow, however, the FP may fail to detect this condition, depending on the type of backlight problem.</p>
<b>SET</b>	Applies the setting and returns to the main menu.
<b>ESC</b>	Cancels the setting and returns to the main menu.



**In the system setting, touching the value displayed on the panel changes the value of the time period.**

### 3.3 Operation Mode Setup and Display Positioning

**SAVE** SAVE

Saves all the adjusted settings in the EEPROM.



- *In the OSD, pressing the **SET** button applies the set value and enables the setting. The set value won't be canceled unless the power is turned OFF or the value is reset.*

*If the power is turned OFF without saving the set value, that data will disappear. The last saved data will be read into the system when the FP starts. To enable the changed value, be sure to press the **SAVE** button.*

- *When the OSD automatically closes after 30 seconds of inactivity, the set value that you were modifying at the time will be retained. If you quit the OSD with the **ESC** button, the value that you were modifying will be not be retained. Instead, the previously set value will be used.*

### 3.3 Operation Mode Setup and Display Positioning

*Memo*

# Chapter 4

## Touch Panel Data

### 4.1 Touch Interface Data

---

Since the FP uses an analog type touch panel, all 1024 x 768 coordinates can be detected. Resolution of the analog touch panel is 1024 x 1024, so a conversion program to convert the coordinates to 1024 x 768 becomes necessary.

Also, a calibration program to adjust the actual touch position is needed.

#### OS and Touch Panel Driver Combinations

OS	Touch I/F Program	Calibration
Windows <sup>®</sup> 95, Windows <sup>®</sup> 98, WindowsNT <sup>®</sup> , Windows <sup>®</sup> 2000, Windows <sup>®</sup> XP	PL-TD000 <sup>*1</sup>	Feature included in the touch I/F program

*\*1 The same PL-TD000 program is used for both English and Japanese.*

#### ■ Touch Panel Coordinate Data

##### (1) Resolution

Both the X and Y coordinates have a resolution of 1024.

The origin point (0,0) is located in the upper left corner of the screen.

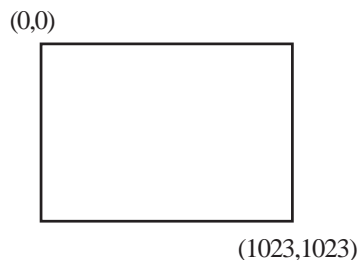

Screen display origin, with resolution of 1024 x 768, is normally at the upper left corner of the screen. Therefore, a software to convert the touch coordinates to display coordinates is needed.

## 4.1 Touch Interface Data

### (2) Data Format

All data is in binary format.

Header: 1 byte (11h= touched; 10h = released)  
 X coordinate: 2 bytes (0 to 3FFh)  
 Y coordinate: 2 bytes (0 to 3FFh)

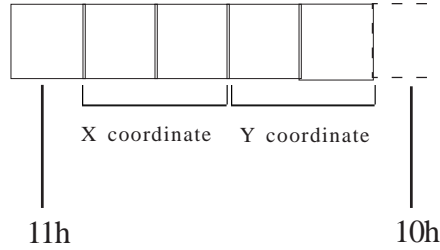

Added when touch is released.

<Example> If the coordinate (X=23(11h), Y=500(1F4h)) is touched.

11h 0h 17h 1h F4h      touched

11h 0h 17h 1h F4h      continuous output with the same location

•  
•  
•  
•

moving the location without releasing touch

11h 0h 17h 1h F4h      continuous data output unless finger is released

11h 0h 17h 1h F4h 10h    when released, only 1 unit of data is sent

# Chapter 5

## Troubleshooting

### 5.1 Troubleshooting

---

#### 5.1.1 Possible Device Problems

---

Possible types of trouble while using this unit are as follows.

No display

- No display appears after the unit is switched on.
- The screen disappears during standard operation.
- The screen does not display normally.

Touch panel does not respond

- The touch panel does not respond when pressed. Its reaction time is abnormally long.



### WARNINGS

- **To prevent an electric shock, be sure the power cord is not connected when wiring the unit.**



- **This section assumes that the FP is the cause of a problem, not the host. When the host is the problem, please refer to its corresponding manual.**

## 5.1 Troubleshooting

### 5.1.2 No Display

When the screen does not display when powering up, or if the screen turns OFF by itself, use the flowchart below to find an appropriate solution.

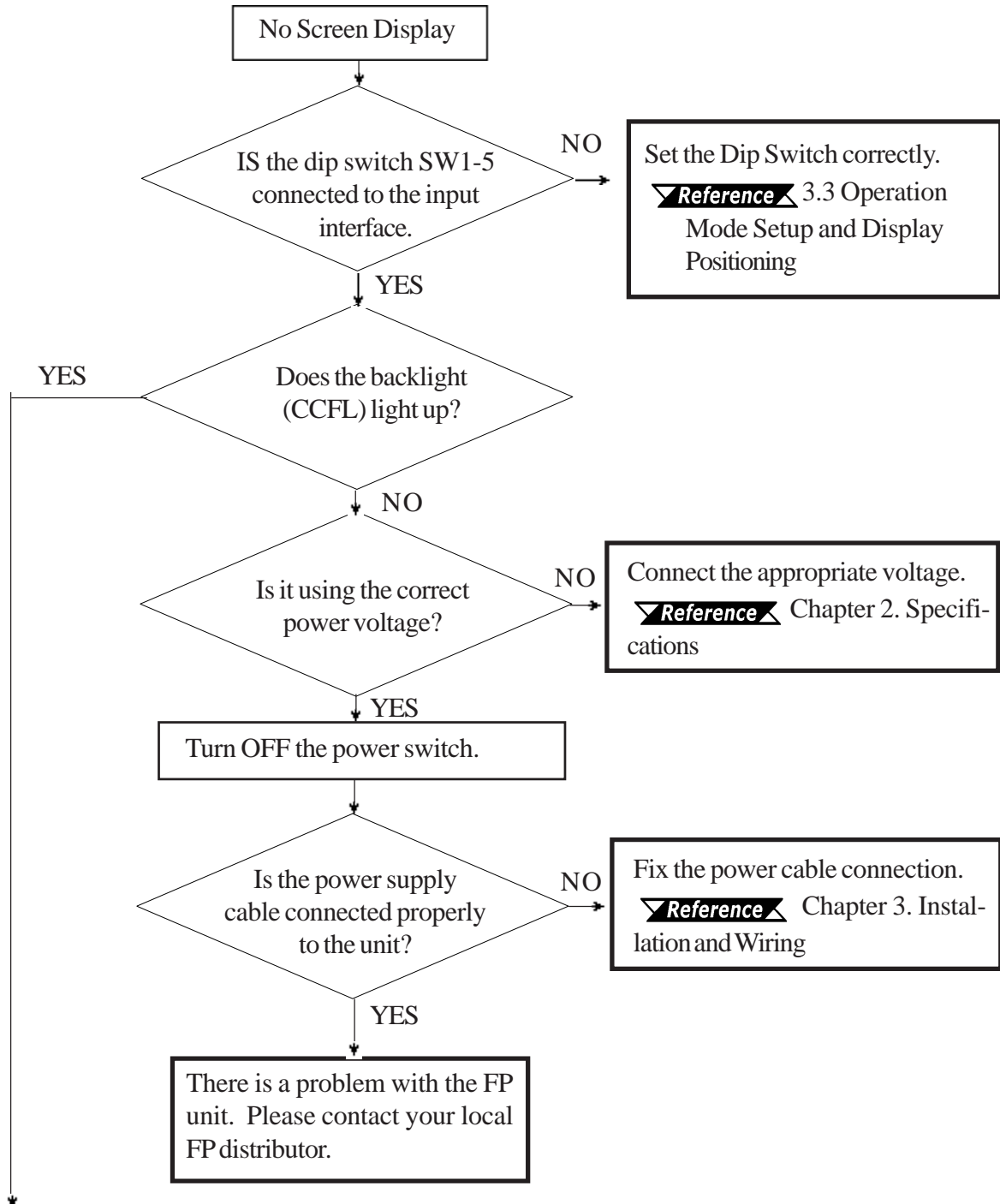

## 5.1 Troubleshooting

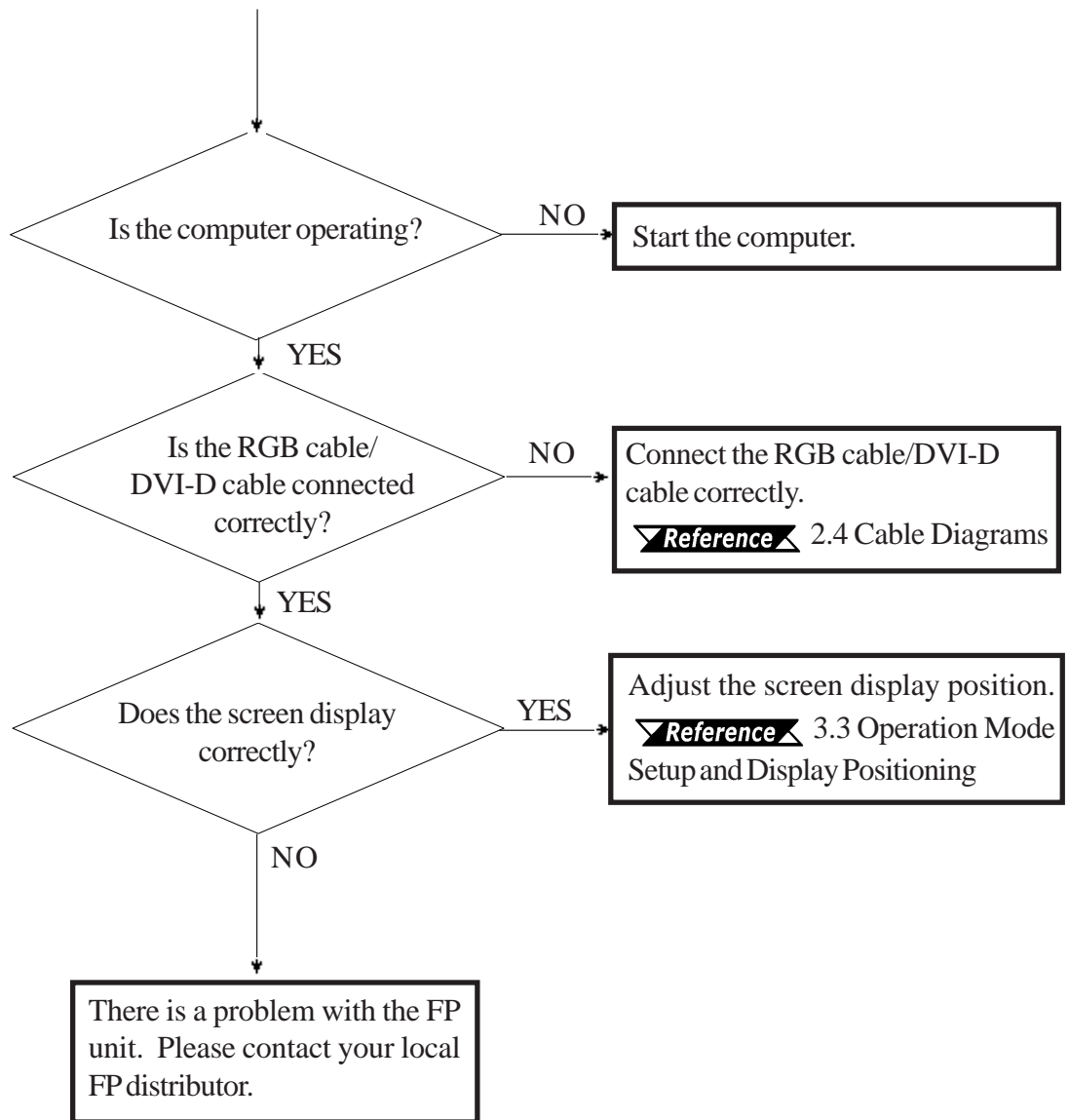



## 5.1 Troubleshooting

### 5.1.3 Touch Panel Does Not Respond

---

When the touch panel does not react, or its reaction is very slow after it is pressed, follow the flowchart below to find the origin of the problem and the appropriate solution.

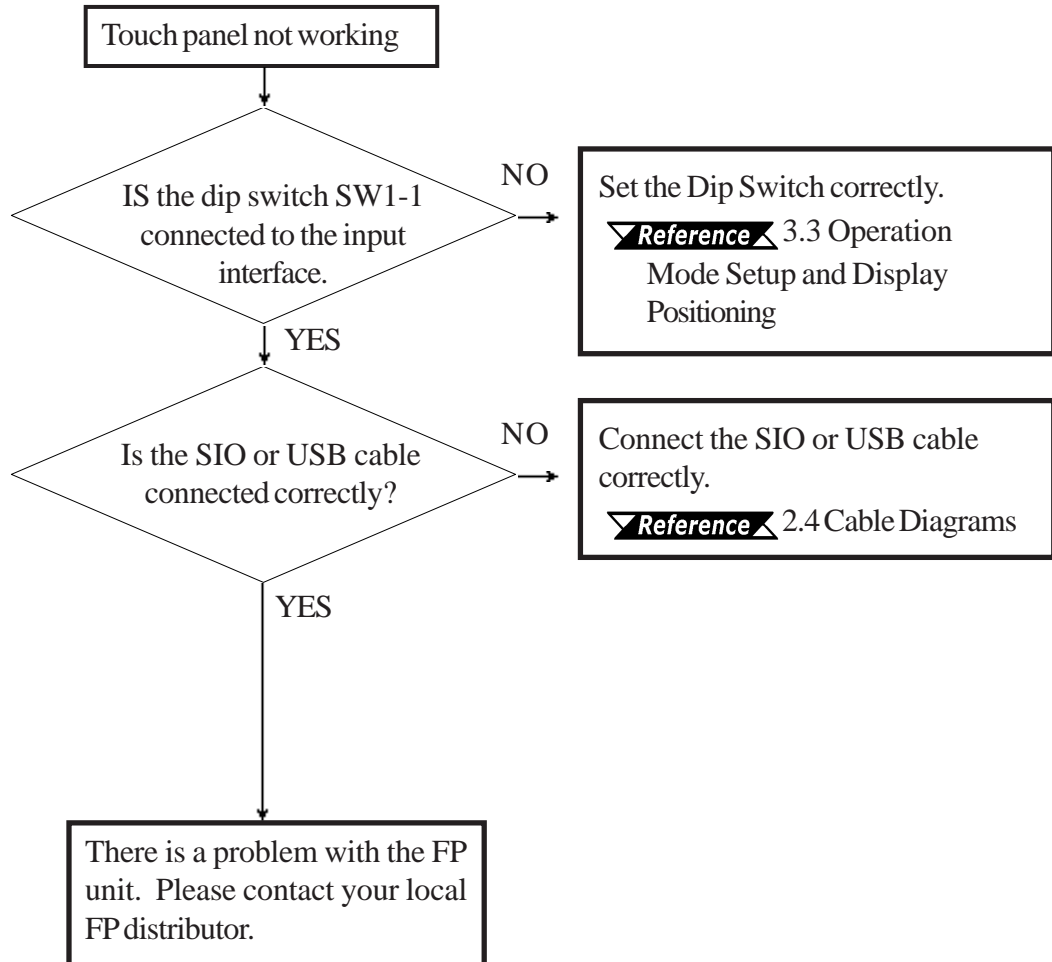

## 5.2 Error Message

---

This section explains the messages that appear when an error has occurred in the FP unit during RUN mode. The problem causing the error message and its related countermeasure are explained in the table below.

*(Only the latest error message will appear on the FP screen)*

### 5.2.1 Error Message List

---

Error Message	Problem	Solution
Out of Range 1 to 4	Signal timing has been input that is not compatible with the FP unit	Set the FP Output settings so that they match the PC's frequency and resolution. <b>Reference</b> 2.3 Interface Specifications
	The dot clock has greatly exceeded of the FP units usable timing range.	
	Resolution has been set that is not compatible with the FP unit.	
No Signal	The PS-2000B unit or a Windows-compatible PC's power has not been turned ON.	Turn on the PS-2000B unit or a Windows-compatible PC's power.
	The PS-2000B unit or a Windows-compatible PC has not been correctly connected to the FP unit.	Connect the RGB cable/DVI-D cable correctly.
	The input I/F and the image input signal type are not the same.	Set the Dip Switch correctly. <b>Reference</b> 4.1.1 Dip Switch Preset Settings and Adjustments

# *Memo*

# Chapter 6 Maintenance

- 1. Regular Cleaning
- 2. Periodic Check Points
- 3. Backlight Replacement

## 6.1 Regular Cleaning

### 6.1.1 Cleaning the Display

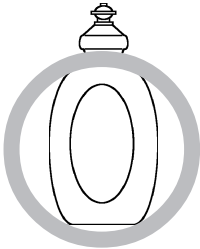

Neutral detergent

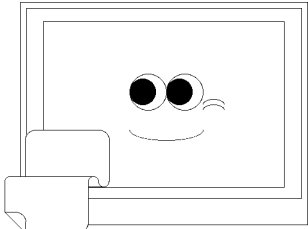

When the display surface or frame become dirty, use a soft cloth moistened with neutral detergent to wipe away any dust or stains.

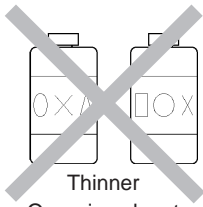

Thinner  
Organic solvent  
Strong acid

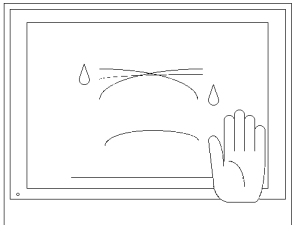

Do not clean the unit with thinner, organic solvents, or strong acids.

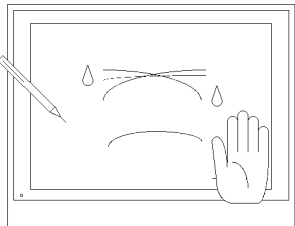

Do not use sharp or hard objects, such as a mechanical pencil or screwdriver, to push on the display. This could damage the unit.

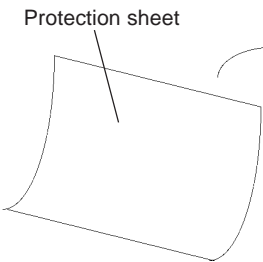

Protection sheet

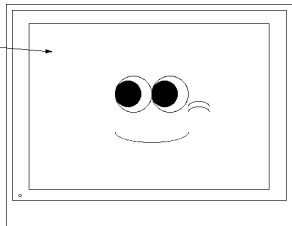

Attach the screen protection sheet when using the FP in extremely dirty or dusty areas.

## 6.1 Regular Cleaning

### 6.1.2 Installation Gasket Replacement

---

The installation gasket protects the FP and improves its water resistance. For instructions on installing the FP's gasket, refer to

**Reference** *Chapter 3 Installation and Wiring*



***A gasket which has been used for a long period of time may have scratches or dirt on it, and could have lost much of its water resistance. Be sure to change the gasket at least once a year, or when scratches or dirt become visible.***

#### ■ Installation Gasket Replacement Procedure

- 1) Place the FP on a flat, level surface with the display facing downwards.
- 2) Remove the old gasket from the FP.
- 3) Attach the new gasket to the FP. Be sure to insert the gasket into the FP's groove so that the gasket's groove sides are vertical.
- 4) Check if the gasket is attached to the FP correctly.

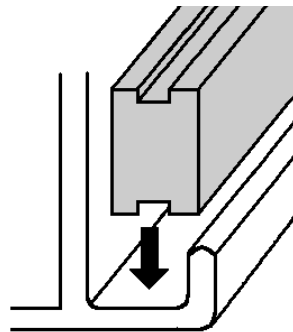



- *The gasket must be inserted correctly into the groove for the FP's moisture resistance to be equivalent to IP65f.*
- *Be sure the gasket's seam is not inserted into any of the unit's corners, only in the straight sections of the groove. Inserting it into a corner may lead to its eventually tearing.*
- *The upper surface of the gasket should protrude approximately 2mm out from the groove. Be sure to check that the gasket is correctly inserted before installing the FP into a panel.*

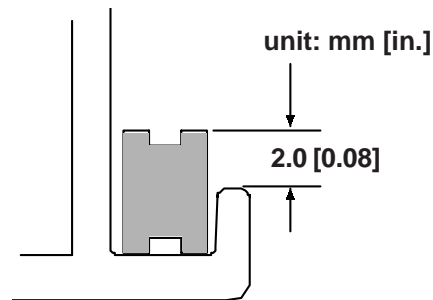

## 6.2 Periodic Check Points

---

To keep your FP unit in its best condition, please inspect the following points periodically.

### FP Operation Environment

- Is the ambient temperature within the allowable range (0°C to 50°C)?
- Is the ambient humidity within the specified range (30%RH to 90%RH, dry bulb temperature of 39°C or less)?
- Is the operating atmosphere free of corrosive gasses?

### Electrical Specifications

- Is the input voltage appropriate (AC85V to AC264V)?

### Related Items

- Are all power cords and cables connected properly? Have any become loose?
- Are all mounting fasteners holding the unit securely?
- Are there any scratches or traces of dirt on the installation gasket?

# 6.3 Backlight Replacement

---

When a burned-out backlight is detected, the status LED flashes alternately green and red, or a steady orange.

The backlight is a cold-cathode tube. Although the FP uses a long-life backlight, replacement may be required earlier than expected depending on the environment where the FP is used.

The life span of the backlight is as follows:

(Time period until the backlight becomes half as bright as a new one)

50,000 hours (approx. 5.7 years)

## WARNINGS

- **Be sure to turn off the power before replacing the backlight. Otherwise, you may receive an electric shock.**
- **The backlight and the FP itself will be very hot just after turning off the power. To avoid burning your skin, be sure to wear gloves when replacing the backlight.**
- **The backlight is very fragile. To avoid possible injury, do not directly touch the glass or pull the cable.**



- *Normally, the FP unit detects a backlight burnout by monitoring the backlight's current flow. However, the FP may fail to detect backlight burnout, or may only detect it before the backlight burns out completely, depending on the type of backlight problem.*



- Please check that the replacement backlight is compatible with the FP.

FP Model No.	Backlight model
FP3700-T41	CA3-BLU15-01

### ■ Backlight Replacement

Follow the procedures given below to replace the FP unit's backlights. Be sure to wear gloves during replacement.



- **Be sure to protect the FP front panel's surface to prevent damage.**
- **The FP has an upper and a lower backlight. Be sure to replace both.**

## 6.3 Backlight Replacement

- 1) Turn off the FP unit's power supply.  
Remove the eight (8) cover attachment screws.

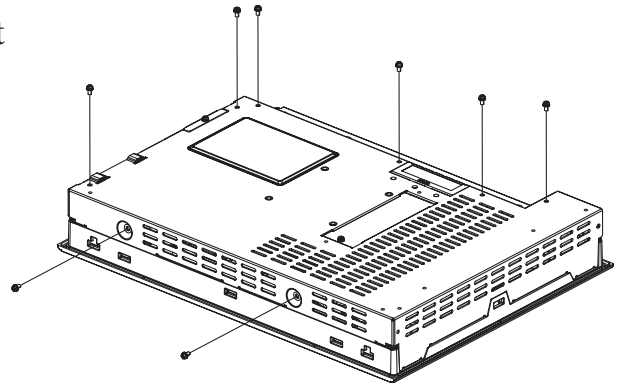

- 2) Remove the FP unit's rear cover.
- 3) Remove the cable from the Inverter Insulation Sheet, and then free the cable from the cable clamp. Next, disconnect the cable connector from the Inverter board's backlight connector.

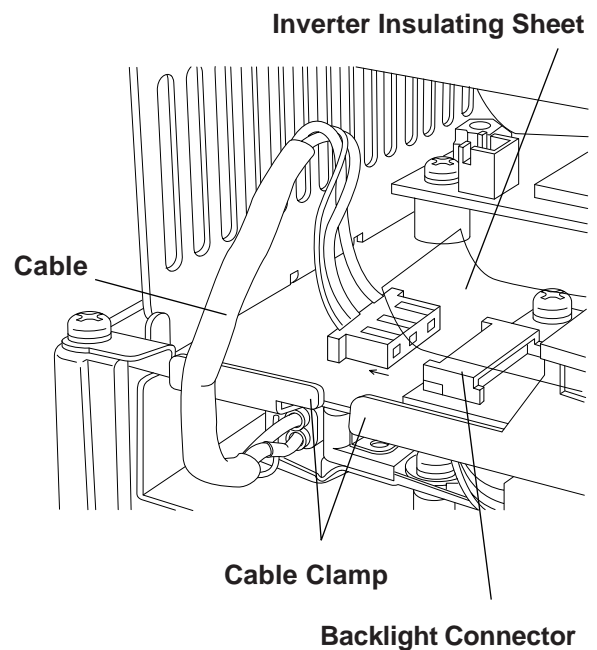

- 4) Insert a screwdriver into the two holes (points) shown below, and remove the backlight attachment screws (1 per hole).

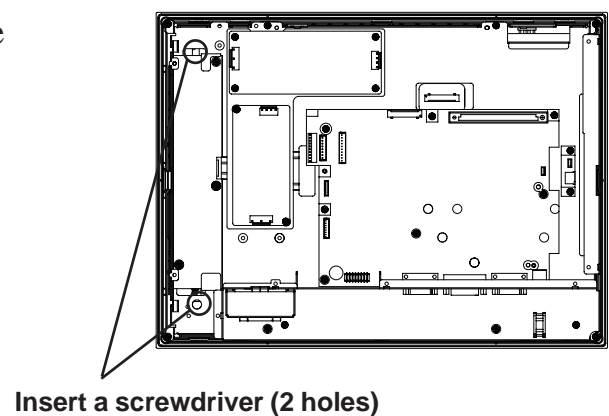



## 6.3 Backlight Replacement

- 5) Pull out the cable in the direction shown by the arrow.



*The entire backlight unit should be changed, not just the backlight.*

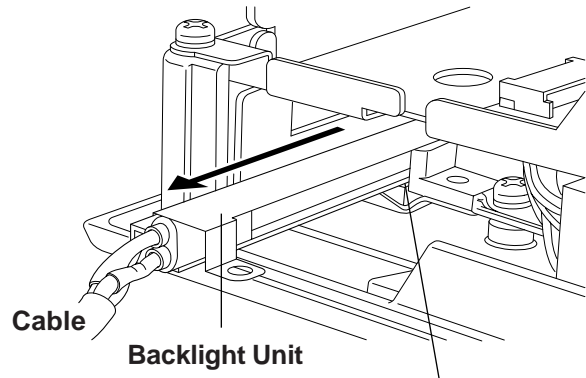

Backlight Unit Insertion Point

- 6) Insert the new backlight unit into the backlight holder.
- 7) Secure both backlights in place using the backlight screws. The necessary torque is 0.147N·m (1.5kgf·cm).
- 8) Connect the backlight power cable to the Inverter board's backlight connector. Fix the cable in place inside the cable clamp, and cover the cable with the Inverter Insulation Sheet. (Reverse of step 3)).



*Be sure the cable is inserted completely into the backlight connector. Failure to do so may cause arcing, which can damage the connector.*

*Be sure to always change both of the FP backlights at the same time.*

- 9) Replace the rear cover and secure it in place using the eight (8) attachment screws.



*The cable clamp is used to prevent the cable from being caught inside in the FP unit and possibly damaged. Be sure to secure the cable clamp around the cable before replacing the rear cover.*