

# FP790-T21 Installation Guide

## WARNINGS

- To prevent an electric shock, be sure to turn FP-790 unit's (hereafter referred to as the "FP") main power supply OFF before attaching the power cord terminals to the FP unit's power terminal strip.
- A fire or electrical shock may occur if voltages used with the FP are beyond the specified range. Be sure to use only the specified voltage.
- Before opening the FP unit's protective cover, be sure to turn the unit's power OFF. This is because the FP unit's internal parts carry high voltages.
- To avoid fires or electrical hazards, do not modify the FP in any way.
- If metal particles, water or other types of liquids contact any of the FP unit's internal parts, immediately turn the unit's power OFF, unplug the power cord, and contact your FP distributor.
- Prior to changing the FP unit's backlight, be sure to disconnect the FP unit's power supply.
- To prevent a possible explosion, do not install the FP in areas containing flammable gases.
- The FP is not appropriate for use with aircraft control devices, aerospace equipment, central trunk data transmission (communication) devices, nuclear power control devices, or medical life support equipment, due to these devices' inherent requirements of extremely high levels of safety and reliability.
- When using the FP with transportation vehicles (trains, cars and ships), disaster and crime prevention devices, various types of safety equipment, non-life support related medical devices, etc. redundant and/or fail-safe system designs should be used to ensure the proper degree of reliability and safety.
- Do not use the FP as a warning device for critical alarms that can cause serious operator injury, machine damage or production stoppage. Critical alarm indicators and their control/activator units must be designed using stand-alone hardware and/or mechanical interlocks.

## CAUTIONS

- Do not push on the FP's screen too strongly, with either your finger or with a hard object. Excessive pressure can scratch, crack or damage the screen. Do not use a pointed object, such as a mechanical pencil or screwdriver, to press any of the touch panel's switches, since it can damage the display.
- If the screen becomes dirty or smudged, moisten a soft cloth with diluted neutral detergent, wring the cloth well, and wipe the display. Do not use thinner or organic solvents.
- Avoid storing and operating the FP in direct sunlight, high temperatures and humidity, and in areas where excessive dust and vibration will occur.
- Avoid using the FP in areas where sudden, extreme changes in temperature can occur. This may cause condensation to form inside the unit, possibly leading to an accident.
- To prevent the FP from overheating, be sure its air circulation vents are clear and clean, and keep the unit's operation area well-ventilated.
- Avoid operating or storing the FP near chemicals, or where chemicals can come into contact with the unit.

# CE Marking Notes

The FP79\*-2\* units are CE marked, EMC compliant products.

<Complies with the following Standards>

- Safety

EN60950

- EMI (EN50081-2)

EN55011 group1 (Class A)

- EMS (EN61000-6-2)

EN61000-4-2, EN61000-4-3, EN61000-4-4, EN61000-4-5, EN61000-4-6, EN61000-4-8, ENV50204

If the following requirements are not met, the FP may fail to meet EN60950 standard requirements.

- The FP must be used as a built-in component of an end-use product.
- Use the FP indoors only.
- When connecting the FP's power cable, be sure to use a cable that is appropriate for the current and voltage used and that has conductive wires that are 0.75 mm<sup>2</sup> or larger.
- When using the FP in an end-use product, be sure to install the FP unit's power cut-off switch where the operator can easily reach it.
- There is a danger of explosion if the backup battery is incorrectly replaced. This battery should be replaced only with same or equivalent type recommended by the manufacturer. Dispose of used batteries according to the manufacturer's instructions.
- Be sure the FP unit's enclosure is an EN60950 approved sheet steel structure.

# Package Contents

The FP package should include the following items:

- **FP Unit**  
(FP790-T21)

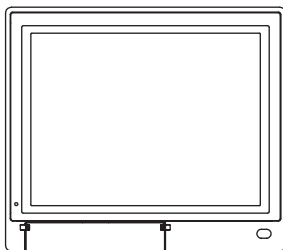

- **Installation Guide**  
(This document)

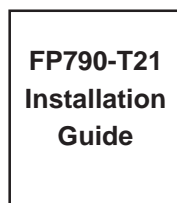

- **CD-ROM (1)** \*1  
(Contains the FP User Manual's PDF file.)



- **Installation Gasket**



- **Installation Brackets (12)**

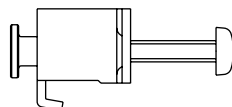

These items have all been carefully packed with special attention to product quality. However, should you find any item(s) damaged or missing, please contact your FP distributor immediately for prompt service.

\*1 For a description and usage of the application programs stored in the CD-ROM, see the "READM\_E.DOC" file.

# About The PDF Manual

The FP unit's CD-ROM contains the following PDF manual file:

**FP-790 Series User Manual (English/Japanese)**

Reading a PDF file requires installation of the Adobe Corporation's Acrobat® Reader.

■ **Acrobat® Reader Installation:**

To install the Acrobat® Reader software, follow the steps given below.

- 1) This software, in the form of a self-extracting file, is located in this CD-ROM in the folder titled [reader]. Use the Explorer software to find the file [reader\ENG\ar405eng.exe], and double-click on the file icon to begin the Reader installation.
- 2) After Installation begins, follow the instructions given on the Installation screens.

■ **Viewing the PDF manual:**

To view the PDF manual contained in this CD-ROM, follow the steps given below.

- 1) Use the Explorer software to locate the file [manual\ENG\fp790e.pdf] in the folder titled [manual].
- 2) Double-click on the PDF file's icon. Acrobat® Reader will automatically start and the first page of the PDF manual will appear.

# 1 FP External Features

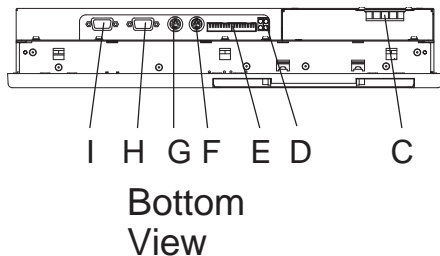
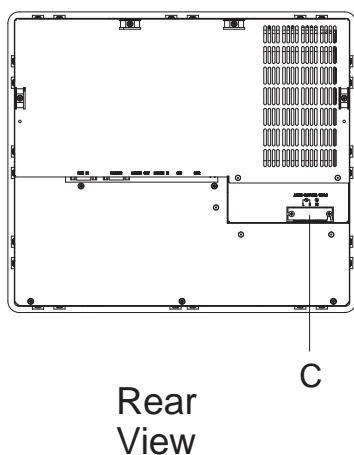
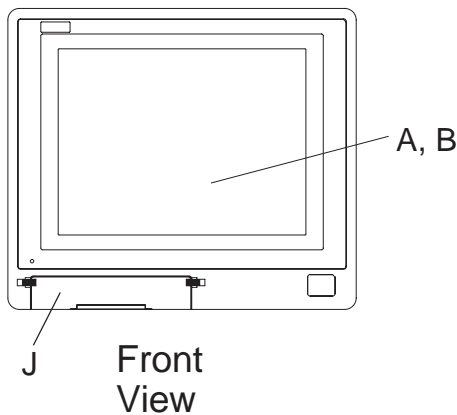

## A: TFT type color LCD

The FP units' output display. Data from the host are displayed.

## B: Touch panel

Used to switch screens and write data to the host.

## C: Power input terminal block

Used to connect the power supply cable.

## D: Status LED (Under development)

## E: Setup switches (DIP switches)

Used to set the FP's operation mode.

## F: MOUSE Connector (MOUSE IN)

Used to connect a mouse.

## G: MOUSE Host connector (MOUSE OUT)

Sends mouse output data from the FP. Connects to the Host's PS/2 equivalent Mouse input connector.

## H: Serial I/F Connector (RS-232C)

Serial RS-232C interface. This connects a serial cable to the FP, and sends FP touch panel data to the Host, and Host commands to the FP.

## I: Analog RGB I/F connector

Analog RGB interface connector

## J: Front Maintenance Cover (unused)



- Prior to attaching peripheral units to the FP, be sure the FP unit's power cord is disconnected from the main power supply.
- To prevent an electrical shock, be sure to disconnect the FP unit's power cord from the power supply before connecting the cord's power terminals or any peripheral devices to the FP.

## 2 FP Dimensions

If detailed dimension information is needed, please contact your local FP distributor.

(Unit: mm [in.] - excluding projections)

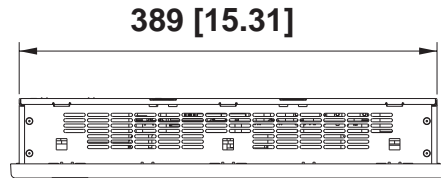

Top View

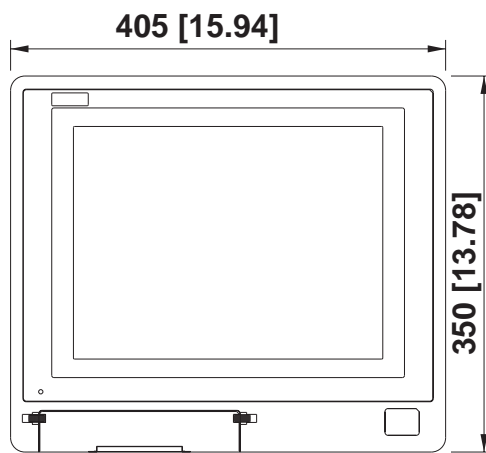

Front View

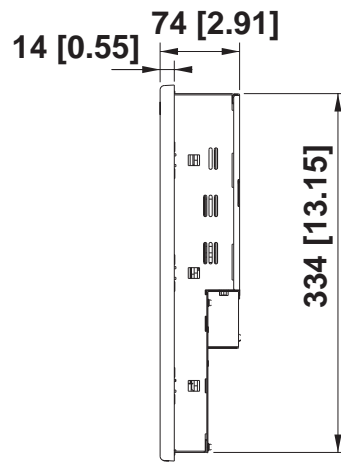

Side View

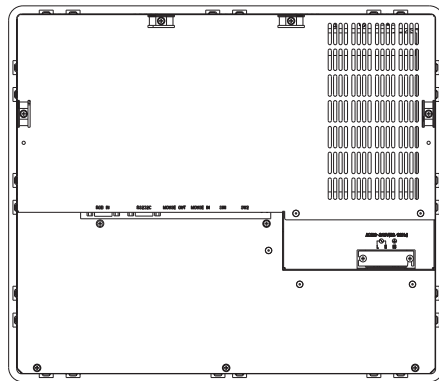

Rear View

### 3 General Specifications

#### ■ Electrical

Input Voltage	AC 100V to AC 240V
Rated Voltage	AC 85V to AC 265V
Frequency	50/60Hz
Allowable Voltage Drop	1 cycle or less
Power Consumption	65VA or less
In-Rush Current	30A (normal), 45A (40°C)
Voltage Endurance	AC 1500V at 20mA for 1 minute (between charging and FG terminals)
Insulation Resistance	Greater than 10MΩ at DC 500V (between charging and FG terminals)

#### ■ Environmental

Ambient Operating Temperature (Cabinet interior and exterior)	0°C to 40°C
Storage Temperature	-10 °C to 60 °C
Ambient Humidity	30% RH to 85% RH (no condensation)
Air Purity Level	0.1mg/m <sup>3</sup> or less (free of conductive particles and dust)
Atmosphere	800 to 1114hPa (2000 meters or lower)
Vibration Resistance	19.6m/s <sup>2</sup> at 10Hz to 25Hz in X, Y, Z directions for 30 minutes
Noise Endurance (via noise simulator)	Noise Voltage: 1500Vp-p Pulse Width: 50ns, 500ns, 1μs Rise Time: 1ns

#### ■ Structural

Grounding	Exclusive grounding only: Less than 100Ω, or your country's applicable standard.
Rating <sup>*1</sup>	Equivalent to IP65f (JEM1030)
Cooling Method	Via natural cooling
Weight	Less than 6.5kg (14.3lb) (with HDD and FDD installed)
External Dimensions	W 405mm [15.94in.] x H 350mm [13.78in.] x D 74mm [2.91in.] (excluding projections)

*\*1 The front face of the PL unit, installed in a solid panel, has been tested using conditions equivalent to the standard shown in the specification. Even though the PL unit's level of resistance is equivalent to the standard, oils that should have no effect on the PL can possibly harm the unit. This can occur in areas where either vaporized oils are present, or where low viscosity cutting oils are allowed to adhere to the unit for long periods of time. If the PL's front face protection sheet becomes peeled off, these conditions can lead to the ingress of oil into the PL and separate protection measures are suggested. Also, if non-approved oils are present, it may cause deformation or corrosion of the front panel's plastic cover. Therefore, prior to installing the PL be sure to confirm the type of conditions that will be present in the PL's operating environment.*

*If the installation gasket is used for a long period of time, or if the unit and its gasket are removed from the panel, the original level of the protection cannot be guaranteed. To maintain the original protection level, you need to replace the installation gasket regularly.*

## ■ Display

<b>Type</b>	TFT color LCD
<b>Colors</b>	260,000
<b>Contrast Control</b>	Possible via adjustment menu
<b>Dot Pitch (mm)</b>	W 0.279 X H 0.279
<b>Effective Display Area (mm)</b>	W 279[10.98] X H 209[8.23]
<b>Display Modes</b> (set via selector switch)	640 X 480 (VGA) 720 X 400 (US Text) 800 X 600 (SVGA) 1024 X 768 (XGA)
<b>Backlight</b>	CFL (under continuous 24 hour operation, lifespan = 10,000 hours)

## ■ Touch Panel

<b>Resolution (dots)</b>	1024 X 1024
<b>Type</b>	Resistive film (Analog)

## ■ External Interfaces

<b>Analog RGB I/F</b>	<b>Input Signal</b>	Analog RGB
	<b>Image Signal</b>	Analog RGB
	<b>Synchronous Signal</b>	TTL Level, negative true or positive true
	<b>Scanning Type</b>	Non-interlaced
	<b>Display Adjustment</b>	Clock adjustment: -128 to 128
		Phase adjustment: 64 levels
	<b>Contrast Control</b>	via touch panel
	<b>Brightness Control</b>	via touch panel
	<b>Color Control</b>	via red, green, blue settings
	<b>Positioning control</b>	Horizontal Display
Vertical Display		
<b>Serial I/F (RS-232C)</b>	Asynchronous Transmission, RS232C, Data Length: 8 bits, Stop Bit: 1, Parity: None, Transfer Speed: 9600bps	
<b>Mouse I/F</b>	(MOUSE IN)	PS/2 Interface mini DIN 6-pin female
	(MOUSE OUT)	PS/2 Interface mini DIN 4-pin female

## 4 Interface Specifications

### ■ Analog RGB Interface

Dsub15-pin (female)

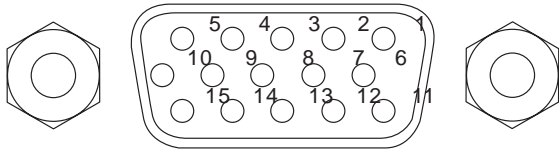

**Screw Size:** (4-40): Inch Type

Pin No.	Signal Name	Condition
1	Analog R	R signal input
2	Analog G	G signal input
3	Analog B	B signal input
4	NC	Not Connected
5	NC	Not Connected
6	Return R	R signal GND
7	Return G	G signal GND
8	Return B	B signal GND
9	NC	Not Connected
10	Digital Ground	Digital signal GND
11	NC	Not Connected
12	NC	Not Connected
13	H. SYNC	Horizontal synchronous signal input
14	V. SYNC	Vertical synchronous signal input
15	NC	Not Connected

**Recommended Connector:**

Mini Dsub 15 pin (JST Co.) KEY-15S-2A3F equivalent

**Connector set screw:**

Inch type (4-40UNC)

**Cable:**

Digital Electronics Corporation RGB cable (FP-CV00, FP-CV01)

VESA Standard Display Mode	Size	Horizontal Frequency	Vertical Frequency	Dot Clock Frequency	Synch. Processing V, H
VGA	640×480	31.469 kHz	59.992 Hz	25.175 MHz	-, -
		37.500 kHz	75.000 Hz	31.500 MHz	-, -
SVGA	800×600	37.879 kHz	60.317 Hz	40.000 MHz	+, +
		46.875 kHz	75.000 Hz	49.500 MHz	+, +
XGA	1024×768	48.363 kHz	60.004 Hz	65.000 MHz	-, -
		56.476 kHz	70.069 Hz	75.000 MHz	+, +
		60.023 kHz	75.029 Hz	78.750 MHz	+, +
US Text	720×400	31.469 kHz	70.087 Hz	28.322 MHz	+, -
		37.927 kHz	85.039 Hz	35.500 MHz	+, -



The allowable frequency fluctuation range in both the horizontal and vertical frequencies is +/- 1%. If fluctuations exceed these ranges, the FP will enter power save mode and the display will go blank.



## ■ RS-232C Interface (COM1/COM2/COM3)

This is an FP-790 Windows<sup>®</sup>-type Mouse Emulator RS-232C connector.

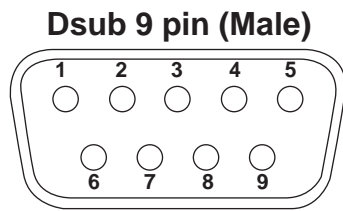

**Screw Size:** (4-40): Inch Type

Pin No.	Signal Name	Meaning
1	CD	Carrier Detect (FP->Host)
2	RXD	Receive Data (FP->Host)
3	TXD	Send Data (FP<-Host)
4	DTR	Terminal Ready (FP<-Host)
5	GND	Ground
6	DSR	Data Set Ready (FP->Host)
7	RTS	Ready to Send (FP<-Host)
8	CTS	Clear to Send (FP->Host)
9	RI	Not used

**Recommended Connector:**

Mini Dsub 9-pin (JST Co.) JEY-9P-1A3F equivalent

**Connector set screw:**

Inch type (4-40UNC)

**Cable:**

Digital Electronics Corporation SIO cable (FP-61V-IS00-0)



- Since all serial interface signals are the same on the PC side, use a straight cable to connect the FP to the PC.
- The GND terminal is the signal ground. Be sure to connect the GND terminal to other unit's SG (signal ground).

## ■ Mouse Connector (MOUSE IN)

### Mini - DIN 6 pin (Female)

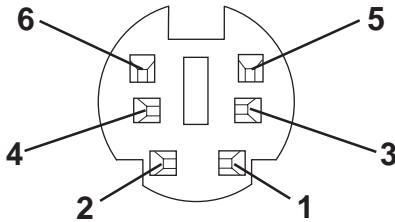

Pin No.	Signal Name
1	Mouse DATA
2	NC
3	GND
4	+5V
5	Mouse CLK
6	NC
SHIELD	GND

Recommended Connector: Hoshi Electronics, Inc.: TCS7568-43-201 or equivalent

Recommended Mouse: Microsoft Corporation Microsoft mouse (PS/2 type)



- *The mouse connection can be used for all equipment conforming to the PS/2 mouse standards. However, Pro-face cannot guarantee the FP will operate normally for all types of host and mouse combinations. This unit was developed using the Microsoft Mouse®. Microsoft's other mouse products, the "IntelliMouse" and the "3 Button" mouse cannot be used with this unit.*
- *When connecting the Mouse, be sure to use the Mouse Type Host connector (MOUSE OUT) and the Host PC Mouse/Keyboard cable (FP-CK01)*
- *Do not connect this cable when the power to the FP and the host (PC) are both ON.*
- **After connecting the mouse, please re-start the Host unit's OS.**
- **When Windows 95 or Windows NT is used, set the "Control panel - Mouse - Motion" feature to the standard pointer speed and hide the pointer trace.**



## ■ Mouse Type Host Connector (MOUSE OUT)

### Mini - DIN 4 pin (Female)

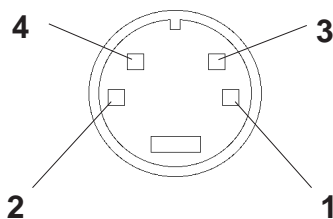

Pin No.	Signal Name
1	GND
2	+V5
3	MOUSE CLK
4	DATA

Recommended Connector: JST Corporation Mini DIN 4-pin (female) MD-S6100 or equivalent



- *If the Host PC Mouse/Keyboard cable (FP-CK01) is not used with the Mouse Type Host connector (MOUSE OUT), the mouse cannot be used.*
- *Do not connect this cable when the power to the FP and the host (PC) are both ON.*

## 5 Installing the FP

### ■ Installation Procedures

Follow the steps given below when installing the FP.

#### ◆ Attaching the Installation Gasket

Even if the your FP unit's Installation Gasket is not needed to prevent water from entering the unit, the gasket also acts as a vibration absorber and should always be attached. To install the gasket, place the FP face down on a soft surface and attach the gasket to the rear side of the display face, in the plastic bezel's groove (see picture below). Be sure the grooved face of the gasket is vertical.



- Before mounting the FP into a cabinet or panel, check that the Installation Gasket is attached to the unit.
- A gasket which has been used for a long period of time may have scratches or dirt on it, and could have lost much of its dust and drip resistance. Be sure to change the gasket periodically, or when scratches or dirt become visible.
- The gasket must be inserted correctly into the groove for the GP's moisture resistance to be equivalent to IP65f.
- The upper surface of the gasket should protrude approximately 2mm out from the groove. Be sure to check that the gasket is correctly inserted before installing the GP into a panel.

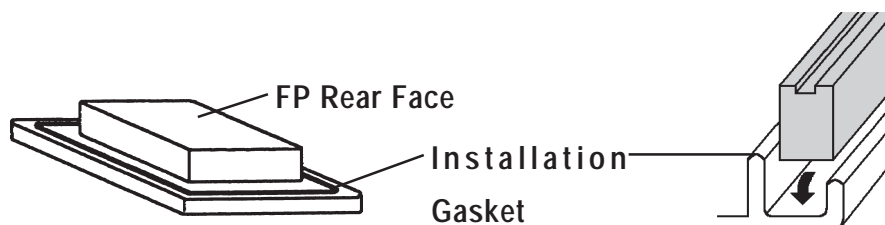

- The gasket is flexible, but not elastic, and may tear if stretched too far. Do not stretch the gasket around the ribs, only push.
- Be sure the gasket's seam is not inserted into any of the unit's corners, only in the straight sections of the groove. Inserting it into a corner may lead to its eventually tearing.

## ◆ Create a Panel Cut

Create a panel cut for the FP, according to the dimensions given here. Two additional items, the installation gasket and installation fasteners are also required when installing the FP.

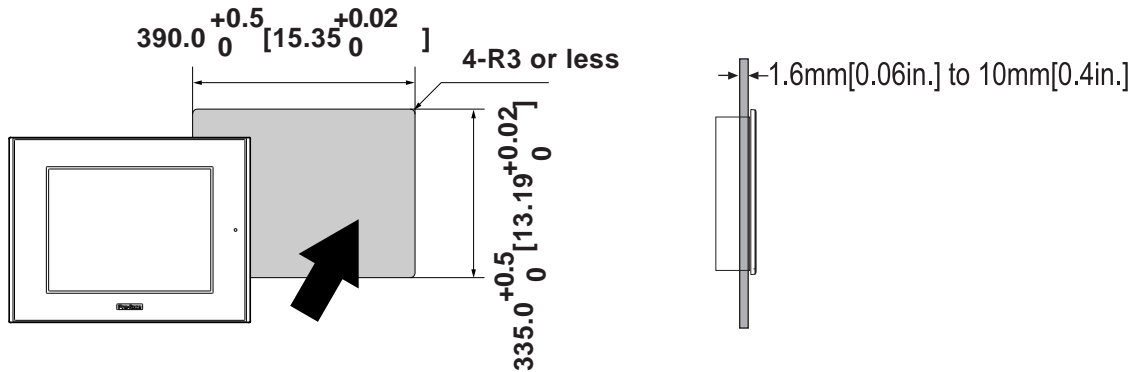

## ◆ Attaching the Installation Fasteners

The FP-790 is equipped with 12 installation fastener holes (3 on each side). Use the drawings below to locate the top and bottom face holes and use a Phillips screwdriver to tighten each fastener.

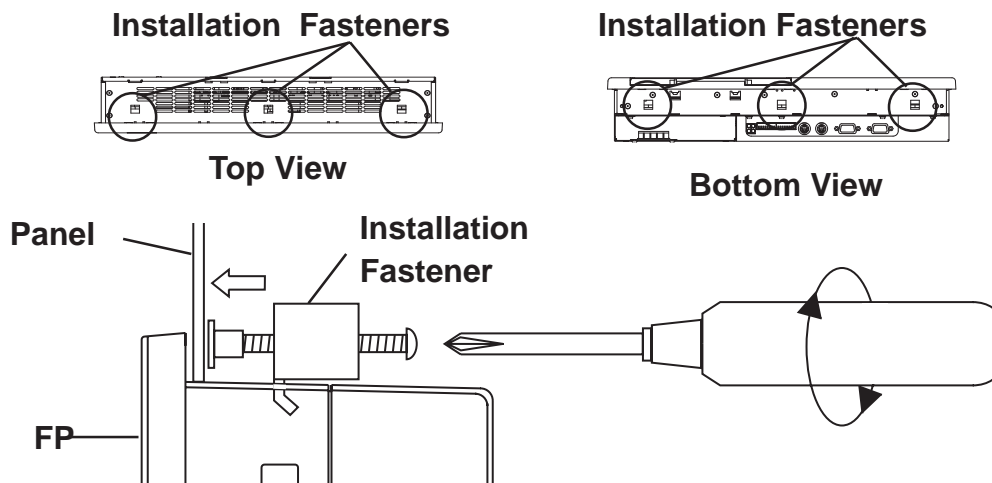

- A torque of only 0.5 to 0.6 N•m is sufficient to tighten these screws. Do not use too much force, since it may damage the FP unit.
- If the dimensions of the Panel Cut are larger than those given here, the panel can warp and distort the FP unit's display.

## 6 Wiring the FP



### WARNINGS

- To prevent an electric shock, be sure to turn FP unit's main power supply OFF before attaching the power cord terminals to the FP unit's power terminal strip.
- Be sure to use only the FP unit's rated power level. Using any other level of power can damage both the power supply and the FP unit.
- Since the FP is not equipped with the power switch, be sure to connect a breaker-type power switch to the FP unit's power cord.



- Use thick wire (2 mm<sup>2</sup> max.) for the FP's power cable. Be sure that the cable is twisted near the ring terminals.
- Use ring terminals with the following dimensions:

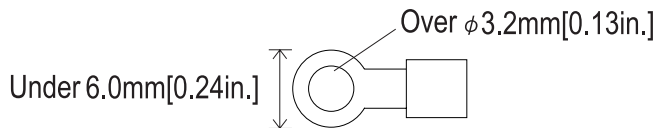

- To prevent the power terminals from being short-circuited due to a loose screw, use ring terminals with insulating sleeves.

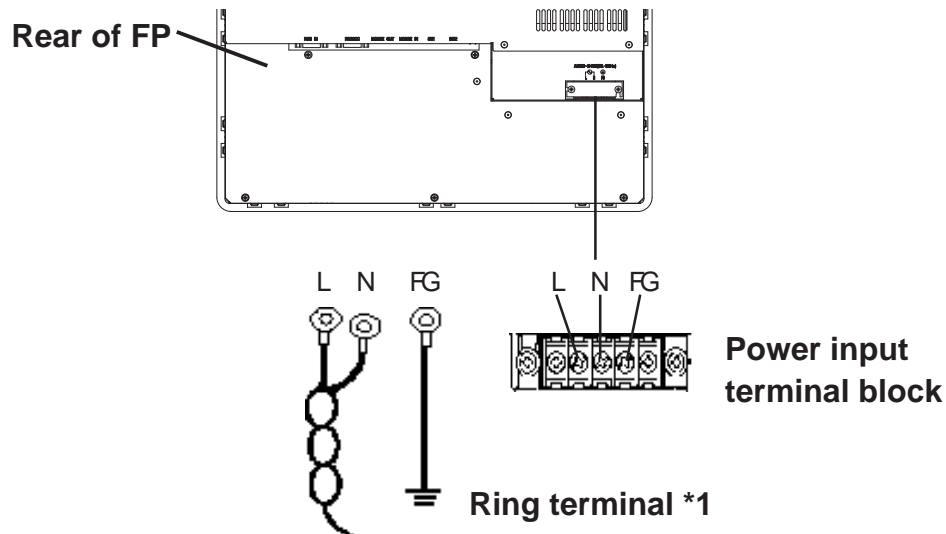

\*1 L = Live line for AC input

N = Neutral line for AC input

FG = Ground terminal to be connected to the FP housing

Recommended ring terminal: V2-MS3 or equivalent (Manufactured by JST Co.)

## 7 Power Supply Cautions

When connecting the FP unit's AC power terminals, please be aware of the following:

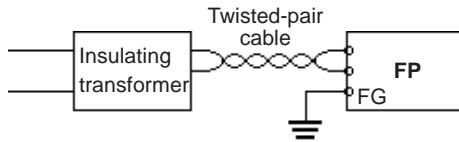
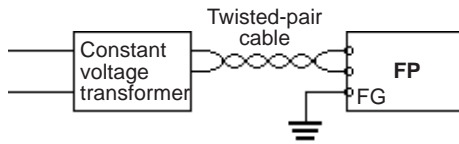

- If voltage fluctuations are expected to vary beyond the specified range, connect a constant voltage transformer.
- Use a low-noise power supply both between the lines and between the FP and its ground. If there is still excess noise, connect an insulating transformer (noise-prevention type) .



**Note:** Be sure any constant or insulating transformer used has a capacity of 100VA or more.

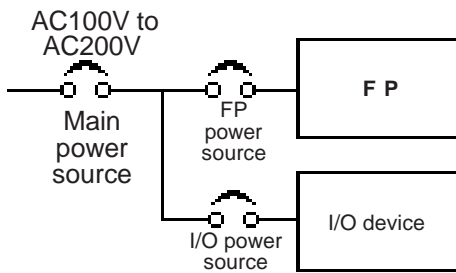

- Wire the power cords of the FP, I/O devices, and power supply devices separately.
- To improve noise immunity, it is recommended to attach a ferrite core to the power cord.

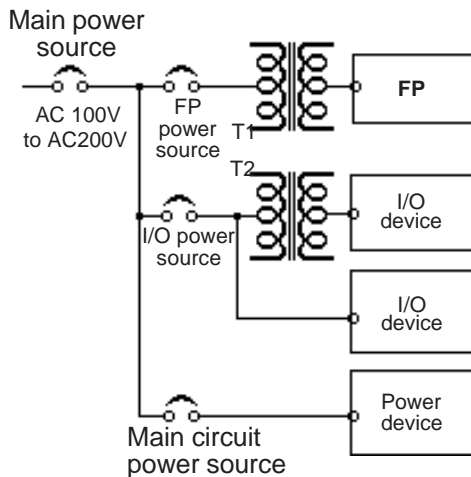

- Isolate the main circuit (high voltage, large current) line, I/O signal lines, and power cord, and do not bind or group them together.
- To prevent damage from lightning, connect a lightning surge absorber.
- To prevent excessive noise, be sure to make the power cord as short as possible.

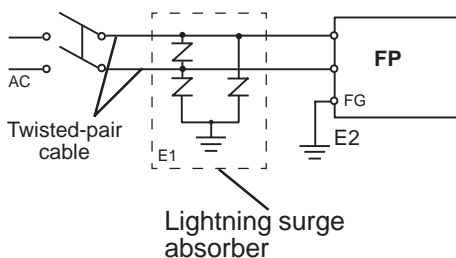

- Ground the lightning surge absorber (E1) and the FP (E2) separately.
- Select a lightning surge absorber which will not exceed the allowable circuit voltage, even when the voltage rises to the maximum.

## (a) Dedicated Ground



- Set up a dedicated ground\*<sup>1</sup> when using the rear panel's FG terminal.

## (b) Shared Ground - allowed

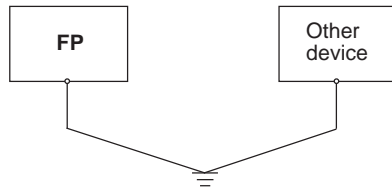

- If a dedicated ground is not possible, use a shared ground, as shown in figure (b).

## (c) Shared ground - not allowed

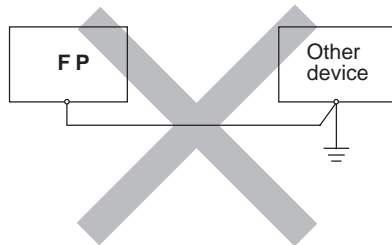

- The grounding wire should have a cross sectional area greater than 2mm<sup>2</sup>. Create the connection point as close to the FP unit as possible, and make the wire as short, as possible. When using a long grounding wire, replace the thin wire with a thicker wire, and place it in a duct.

*\*1 Use a grounding resistance of less than 100Ω and a 2mm<sup>2</sup> or greater thickness wire, or your country's applicable standard. For details, contact your local FP distributor.*

## 9 Changing the Backlight

The FP-790 unit's backlight is user replaceable.

For detailed information about changing the backlight, refer to the FP-790 User Manual (sold separately) or the Replacement Backlight (sold separately) explanation.

The FP-790 uses the following backlight.

FP Model	Backlight Model
FP790-T21	FP790-BL00



Be sure to use only Pro-face's recommended backlight. Use of any other backlight can lead to an accident or FP unit malfunction.

### Note

Be aware that the Digital Electronics Corporation shall not be held liable for any real or estimated damages or losses, or third party claims resulting from the use of this product.