

# FP2500-T12 / FP2600-T12

## Installation Guide



### WARNINGS

- Prior to connecting the FP2500-T12/FP2600-T12 (hereafter referred to as the "FP" or FP unit) unit's power cord terminals to the Terminal Block, be sure to check that the FP unit's power supply is completely turned OFF, via a breaker, or similar unit.
- Whenever changing the backlight be sure to unplug the FP unit's power cord and wear protective gloves to prevent electric shocks and burns.
- Do not open or remodel the FP unit. Doing so may lead to a fire or electric shock.
- Do not use voltage levels that exceed the FP unit's specified voltage range. Doing so may cause a fire or an electric shock.
- Do not use the FP in an environment where flammable gases are present, since operating the FP may cause an explosion.
- Do not use the FP as a warning device for critical alarms that can cause serious operator injury, machine damage or production stoppage. Critical alarm indicators and their control/activator units must be designed using stand-alone hardware and/or mechanical interlocks.
- Do not use FP unit touch panel switches in human-safety-related or important disaster prevention situations. For safety-related switches, such as an emergency stop switch, be sure to use a separately installed mechanical switch.
- After the FP unit's backlight burns out, unlike "Standby Mode", the unit's touch panel is still active. If the operator fails to notice that the backlight is burned out and touches the panel, a potentially dangerous machine operation error can occur. Therefore, do not use FP unit touch-screen switches for the control of equipment safety mechanisms, such as Emergency Stop switches, etc. that protect humans from injury and equipment from damage.

If your FP unit's backlight suddenly turns OFF, use the following steps to determine if the backlight is actually burned out.

- 1) If your currently running FP application is not set to turn the backlight OFF, and the screen has gone blank, your backlight is burned out.
  - 2) If your current FP application is set to turn the backlight OFF, if touching a corner of the screen does not cause the display to reappear, your backlight is burned out.
- To prevent operator injury or machine damage, be sure to design your machine operation system so that the machine will not malfunction due to a communication fault between the FP unit and its host controller.
  - Do not use the FP with aircraft control devices, aerospace equipment, central trunk data transmission (communication) devices, nuclear power control devices, or medical life support equipment, due to these devices' inherent requirements of extremely high levels of safety and reliability.
  - When using the FP with transportation vehicles (trains, cars and ships), disaster and crime prevention devices, various types of safety equipment, non-life support related medical devices and others, be sure to use redundant and/or failsafe system designs to ensure the appropriate degree of system reliability and safety.

### **To prevent this unit from malfunctioning:**

- Do not strike the FP unit's touch panel with a hard or heavy object, or press on the touch panel with too much force, since it may damage the display.
- Do not install the FP where the temperature will exceed the specified range.
- Be sure that water, liquids or metal particles do not enter the FP, since it may cause a malfunction or a short circuit.
- Do not install the FP where sudden, large changes in temperature may occur. These changes may cause condensation to form inside the unit, possibly leading to a malfunction.
- To prevent excessive heat from building up inside the unit, do not install the FP where its ventilation holes may be blocked. Also, do not install or store the FP near high temperature equipment.
- Do not install or store the FP where direct sunlight or high levels of dust exist.
- Since the FP is a precision instrument, do not install or store it where either strong shocks or excessive vibration may occur.
- Do not install or store the FP in an area containing chemicals or chemical fumes.
- Do not use paint thinner or organic solvents to clean the FP unit's case or screen.
- After turning the FP OFF, be sure to wait a few seconds before turning it ON again. If the FP is started too soon, it may not start up correctly.

## **Package Contents**

The following items are included in the FP unit's package. Before using the FP, please confirm that all items listed here are present.

- **FP unit (FP2500-T12/FP2600-T12)**
- **CD-ROM (1)**  
(Contains the FP-2500/FP-2600 Series User Manual and Touch Panel Programs for MS-DOS®)
- **Installation Gasket (1)**
- **Installation Brackets (4/set)**
- **FP2500-T12/FP2600-T12 Installation Guide (1) (this manual)**
- **USB Cable Strap (1)**

This unit has been carefully packed, with special attention to quality. However, should you find anything damaged or missing, please contact your local FP distributor immediately.

## **Options**

- **Cables**
- **Touch Panel Driver Software**
- **Maintenance Parts**

# About The Manual

The FP2500-T12/FP2600-T12 unit's PDF manual file (fp2000e.pdf) is contained in the CD-ROM's [Manual\Eng] folder.

Reading a PDF file requires installation of the Adobe Corporation's Acrobat® Reader.

## ■ Acrobat® Reader Installation:

To install the Acrobat® Reader software, follow the steps given below.

- 1) This software, in the form of a self-extracting file, is located in this CD-ROM in the folder titled [reader]. Use the Explorer software to find the file [Reader\Eng\ ar505enu.exe], and double-click on the file icon to begin the Reader installation.
- 2) After installation begins, follow the instructions given.

Acrobat® Reader Copyright© Adobe Systems Incorporated. All rights reserved.

## 1 Part Names

Front View

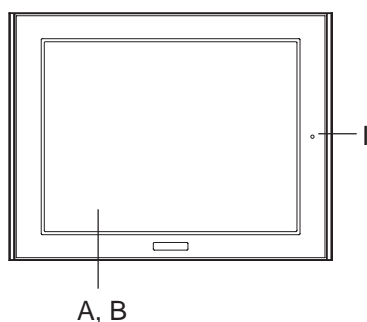

Rear View

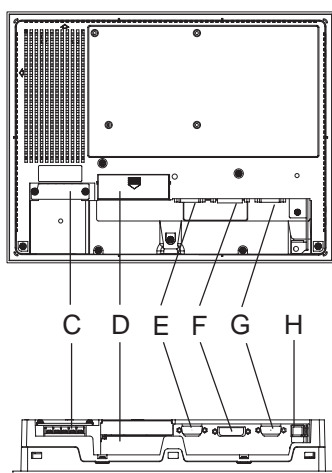

Bottom View

### **A: TFT Color LCD**

Displays host data.

### **B: Touch Panel**

Switches screens or writes/sends data to the host.

### **C: Power Input Terminal Block**

Provides power to the FP unit via the input and ground terminals.

### **D: Dip Switch Cover**

Covers the FP unit's operation mode dip switches.

### **E: Analog RGB Interface Connector**

Connector for analog RGB cable.

### **F: DVI-D Interface Connector**

Connector for DVI-D cable.

### **G: RS-232C Interface Connector**

Connector for RS-232C (serial) cable. Used for sending touch panel data to the host, and receiving commands from the host.

### **H: USB Interface Connector**

Connector for USB cable. Used for sending touch panel data to the host, and receiving commands from the host.

### **I: Front LED**

Used to indicate power supply, backlight or image signal input status.

## 2 Dimensions

### ■ FP2500-T12

Unit:mm [in]

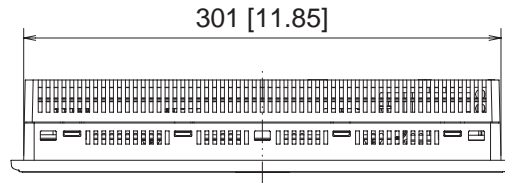

Top View

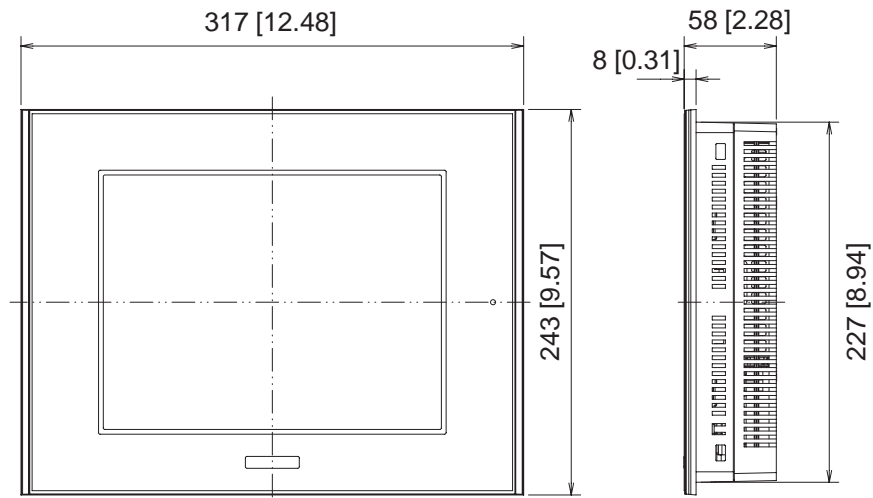

Front View

Side View

### ■ FP2600-T12

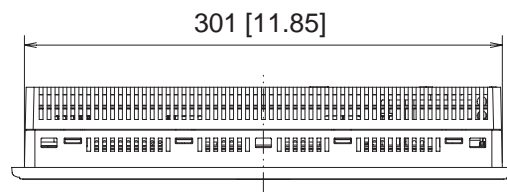

Top View

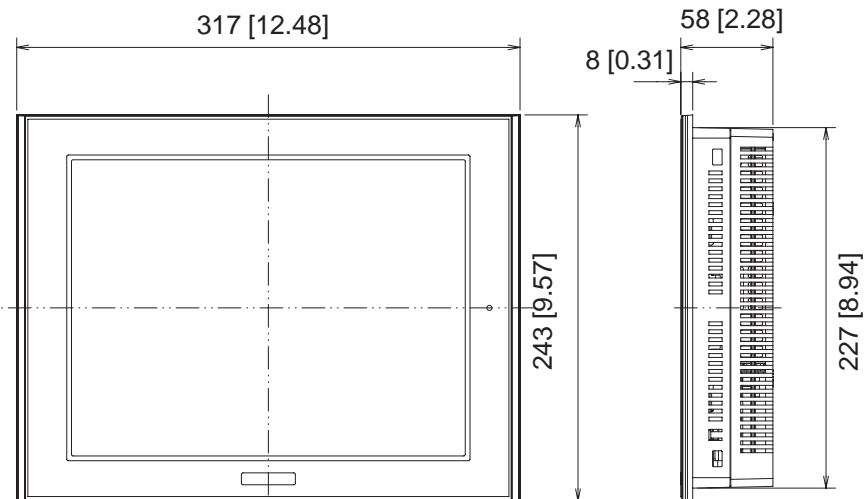

Front View

Side View

## 3 Dip Switches

The FP unit's dip switches are located behind the Dip Switch Cover. After changing any dip switch settings, be sure to restart your FP unit.

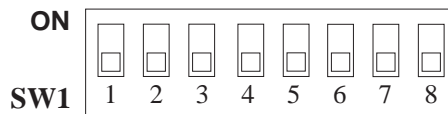

SW No.	Function	Description	Factory Settings
1-1	Switch between USB and RS-232C for touch panel data transmission.	Used to set the touch panel data input (command control) method to either USB or RS-232C. ON : USB OFF : RS-232C (Default setting)	All OFF
1-2	Display/hide the OSD.	Used to display or hide the OSD. ON : Hide OFF : Display (Default setting)	
1-3	Reserved	Set this switch to OFF	
1-4			
1-5	Switch between analog RGB and DVI-D input.	Used to change the image input method. ON : DVI-D OFF : analog RGB (Default setting)	
1-6	Reserved	Be sure these switches are always set to OFF	
1-7			
1-8			

## 4 Interfaces

### Analog RGB Interface

Input Signal Type	Analog RGB
Input Signal Characteristics	Image signal: analog RGB Synchronous signal: TTL level, negative true or positive true Scanning type: non-interlace
OSD Settings (On Screen Display)	CONTRAST BLACK LEVEL H-POS V-POS OSD H-POSITION PHASE BACKLIGHT DEFAULT (ALL CLEAR)

The FP unit's available screen resolutions are as follows: (Unit: dot/pixel)

<FP2500-T12>

Size	H Sync. (kHz)	V Sync. (Hz)	Dot Clock (MHz)	Screen Resolution Expansion (H: Horizontal) (V: Vertical)	Display Resolution
640×350 <sup>*1</sup>	31.469	70.000	25.175	× 1.0 (H) × 1.2 (V)	640 × 420
640×400	31.469	70.000	25.175		640 × 480
640×400	24.827	56.420	21.053		640 × 480
640×480	31.469	59.992	25.175	× 1.0	640 × 480
720×350 <sup>*1,2</sup>	31.469	70.000	28.320	× 1.0 (H)	640 × 420
720×400 <sup>*1</sup>	31.469	70.000	28.320	× 1.2 (V)	640 × 480

Select "720 x 400 Display Resolution 720 x 400 DSP" in the OSD (On Screen Display) "System Setting" screen.

\*1 When the 350 pixel (vertical) signal setting is selected, 400 pixels, including 50 pixels at the top and at the bottom of the screen, will be enlarged and displayed at 480 pixels (1.2times).

\*2 When the 720 pixel (horizontal) signal setting is selected,

- When "720 x 400 DSP" is ON; only 640 pixels are displayed (80 pixels are not displayed.)
- When "720 x 400 DSP" is OFF; all pixels are displayed but images may be cut off if they do not match the sampling.

<FP2600-T12>

Size	H Sync. (kHz)	V Sync. (Hz)	Dot Clock (MHz)	Screen Resolution Expansion (H: Horizontal) (V: Vertical)	Display Resolution
640×350 <sup>*1</sup>	31.469	70.000	25.175	× 1.25 (H) × 1.5 (V)	800 × 525
640×400	31.469	70.000	25.175		800 × 600
640×400	24.827	56.420	21.053		800 × 600
640×480	31.469	59.992	25.175	× 1.25 (H) × 1.25 (V)	800 × 600
640×480	35.000	66.670	30.240		800 × 600
640×480	37.861	72.810	31.500		800 × 600
720×350 <sup>*1,2</sup>	31.469	70.000	28.320	× 1.0 (H)	720 × 525
720×400 <sup>*1</sup>	31.469	70.000	28.320	× 1.5 (V)	720 × 600
800×600	35.156	56.250	36.000	× 1.0	800 × 600
800×600	37.879	60.317	40.000		800 × 600

\*1 When the 350 pixel (vertical) signal setting is selected, 400 pixels, including 50 pixels at the top and at the bottom of the screen will be enlarged and displayed at 600 pixels (1.5times).

\*2 Select "720 x 400 Display Resolution 720 x 400 DSP" in the OSD (On Screen Display) "System Setting" screen.

## Pin Assignments and Signal Names for Analog RGB

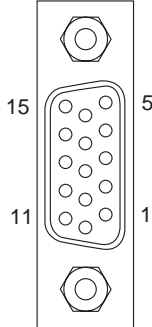
Pin No.	Signal Name	Condition	Pin Location
1	Analog R	R signal input	
2	Analog G	G signal input	
3	Analog B	B signal input	
4	Reserved	NC (spare for input)	
5	Digital grounding	Digital signal GND	
6	Return R	R signal GND	
7	Return G	G signal GND	
8	Return B	B signal GND	
9	Reserved	NC (spare for input)	
10	Digital grounding	Digital signal GND	
11	Reserved	NC (spare for input)	
12	Reserved	NC (spare for input)	
13	H. SYNC	Horizontal synchronous signal input	
14	V. SYNC	Vertical synchronous signal input	
15	Reserved	NC (spare for input)	

Connector: Mini Dsub 15 pin male  
 Connector set screw: Inch type (4-40)  
 Analog RGB Cable: FP-CV02-45, FP-CV00, FP-CV01 (VGA standard)  
 (Manufactured by Digital Electronics Corporation of Japan)



**If a cable other than the specified Analog RGB cable is used, FP unit operation cannot be guaranteed due to the possibility of noise interference.**

## DVI-D Interface

Input signal type	DVI-D
Setting by OSD (On Screen Display)	H-POS V-POS BACKLIGHT DEFAULT (ALL CLEAR)

The number of dots (pixels) displayed are as follows:

<FP2500-T12>

Size	H Sync. (kHz)	V Sync. (Hz)	Dot Clock (MHz)	Screen Resolution Expansion (H: Horizontal) (V: Vertical)	Display Resolution
640×400	31.469	70.000	25.175	× 1.0 (H)	640 × 480
640×400	24.827	56.420	21.053	× 1.2 (V)	640 × 480
640×480	31.469	59.992	25.175	× 1.0	640 × 480
720×400 <sup>*1</sup>	31.469	70.000	28.320	× 1.0 (H) × 1.2 (V)	640 × 480

\*1 When the horizontal 720 pixel signal is input;

- VGA Graphic & Text mode displays 640 pixels only and 80 pixels are not displayed.

<FP2600-T12>

Size	H Sync. (kHz)	V Sync. (Hz)	Dot Clock (MHz)	Screen Resolution Expansion (H: Horizontal) (V: Vertical)	Display Resolution
640×400	31.469	70.000	25.175	× 1.25 (H) × 1.5 (V)	800 × 600
640×400	24.827	56.420	21.053		800 × 600
640×480	31.469	59.992	25.175	× 1.25 (H) × 1.25 (V)	800 × 600
640×480	35.000	66.670	30.240		800 × 600
640×480	37.861	72.810	31.500		800 × 600
720×400 <sup>*1</sup>	31.469	70.000	28.320	× 1.0 (H) × 1.5 (V)	720 × 600
800×600	35.156	56.250	36.000	× 1.0	800 × 600
800×600	37.879	60.317	40.000		800 × 600

\*1 When you use this resolution, select "720 x 400 Display Resolution 720 x 400 DSP" in "System Setting" of the OSD (On Screen Display).

**DVI-D Pin Assignments and Signal Names**

Pin No.	Signal Name	Pin No.	Signal Name	Pin Location
1	TMDS DATA2-	13	NC	
2	TMDS DATA2+	14	NC	
3	TMDS DATA2/4 SHIELD	15	GND (+5V)	
4	NC	16	Hot Plug Detect	
5	NC	17	TMDS DATA0-	
6	DDC Clock	18	TMDS DATA0+	
7	DDC Data	19	TMDS DATA0/5 SHIELD	
8	NC	20	NC	
9	TMDS DATA1-	21	NC	
10	TMDS DATA1+	22	TMDS CLOCK SHIELD	
11	TMDS DATA1/3 SHIELD	23	TMDS CLOCK+	
12	NC	24	TMDS CLOCK-	

Connector: DVI-D 24-pin male

Connector set screw: Inch type (4-40)

DVI-D Cable: FP-DV01-50 <5m> (Manufactured by Digital Electronics Corporation of Japan)



**If a cable other than the specified DVI-D cable is used, FP unit operation cannot be guaranteed due to the possibility of noise interference.**

■ **RS-232C Interface**

RS-232C Interface	Baud rate: 9600 bps Data length: 8 bits Parity: none Stop bit: 1
-------------------	---



## RS-232C (Serial) Interface Pin Assignments and Signal Names

Pin No.	Signal Name	Condition	Pin Location
1	CD	Carrier Detect *1	
2	RD	Receive Data (FP→Host)	
3	SD	Send Data (FP←Host)	
4	DTR	Data Terminal Ready *1	
5	GND	Ground	
6	DSR	Data Set Ready *1	
7	RS	Request to Send (FP←Host)	
8	CS	Clear to Send (FP→Host)	
9	NC	(Used internally)	

Connector : Dsub 9 pin female  
 Connector set screw : Inch type (4-40)  
 RS-232C Cable : FP61V-IS00-O  
 (Manufactured by Digital Electronics Corporation of Japan)

\*1 The FP unit's CD, DTR, and DSR lines are connected internally.

### Signal Names

Signal names used for FP unit RS-232C interfaces are designed to match the pin order used on most PC serial connectors, which allows a straight cable to be used to connect the two. Therefore, connect each FP connector pin's signal to the same signal signal on the PC side.

For example, the FP unit connector's pin #2 'RD' should be connected to the PC connector's 'RD' terminal. Refer to the FP2500-T12/FP2600-T12 User Manual's "Cable Diagrams" section for detailed signal direction information.



***If a cable other than the specified RS-232C cable is used, FP unit operation cannot be guaranteed due to the possibility of noise interference.***

## ■ USB Interface

### Pin Assignments and Signal Names for USB Interface

Pin No.	Signal Name	Condition	Pin Location
1	USB1-5V	+5VIN	
2	USBD1(-)	USBdata(-)	
3	USBD1(+)	USBdata(+)	
4	GND	Ground	

Communication : Low speed Device  
 Connector : B type connector  
 USB Cable : FP-US00  
 (Manufactured by Digital Electronics Corporation of Japan)



***If a cable other than the specified USB cable is used, FP unit operation cannot be guaranteed due to the possibility of noise interference.***

# 5 Installation

## ■ Confirm the Installation Gasket's Positioning

It is strongly recommended that you use the gasket, since it absorbs vibration in addition to repelling water.

Place the FP on a level surface with the display panel facing downward. Check that the FP unit's installation gasket is seated securely into the gasket's groove, which runs around the perimeter of the panel's frame.



- **Before installing the FP into a cabinet or panel, check that the installation gasket is securely attached to the unit.**
- **A gasket which has been used for a long period of time may have scratches or dirt on it, and could have lost much of its dust and drip resistance. Be sure to change the gasket periodically or when scratches or dirt become visible.**
- **Be sure to use gasket model GP570-WP10-MS.**
- **Be sure the gasket's seam is not inserted into any of the unit's corners, only in the straight sections of the groove. Inserting it into a corner may lead to its eventually tearing.**
- **To ensure the installation gasket's maximum level of moisture resistance, be sure the gasket's seam is inserted as shown into the panel's bottom face.**

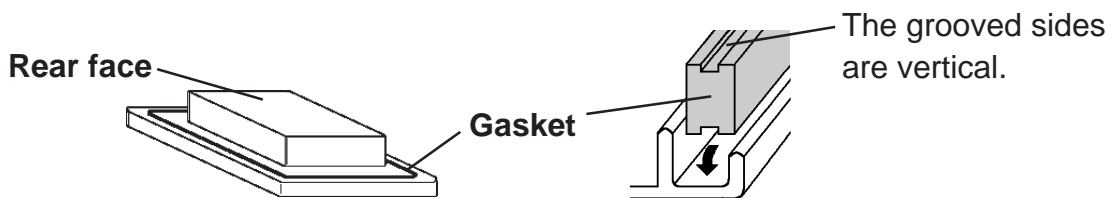

## ■ Create a Panel Cut and insert the FP into the panel from the front

Unit: mm [in]

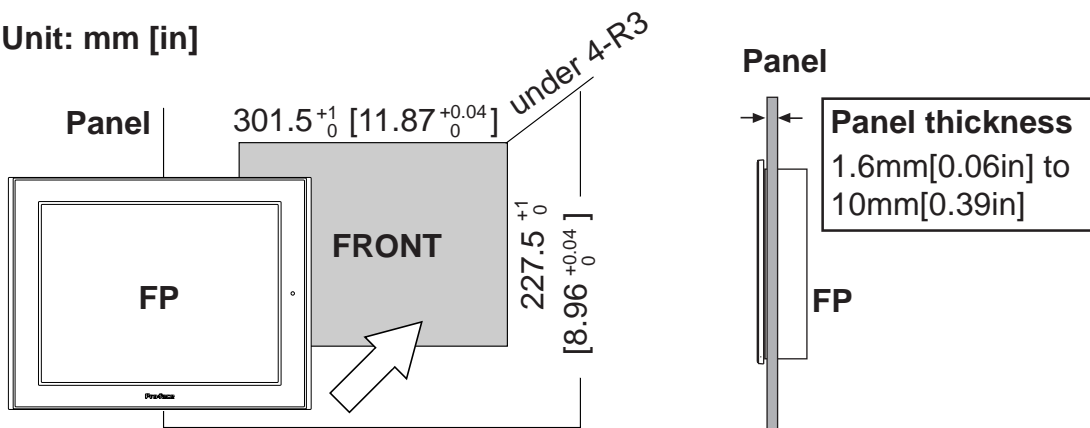

## ■ Attach the Installation Fasteners from Inside the Panel

The following figures show the four(4) fastener insertion slot locations. Insert each fastener's hook into the slot. Tighten the screws in a diagonal pattern, and slowly increase the torque.

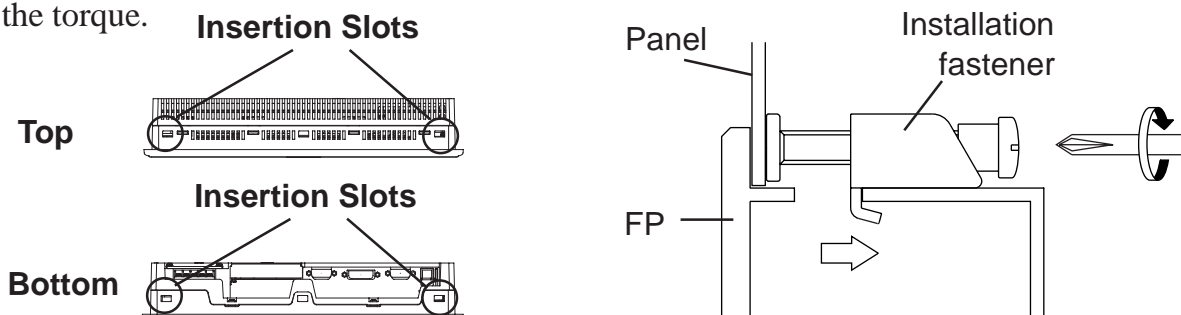



- **Tightening the screws with too much force can damage the FP unit's case.**
- **The necessary torque is 0.5N•m.**



- Depending on the installation panel's thickness, etc., the number of installation fasteners used may need to be increased provide the desired level of moisture resistance.
- Installation fastener model number : GP070-AT01.

## 6 Wiring

### WARNINGS

- To avoid an electric shock, when connecting the FP unit's power cord terminals to the power terminal block, confirm that the power supply is completely turned OFF, via a breaker, or similar unit.
- FP2500-T12 and FP2600-T12 units are designed to use only AC100V to AC240V input. Any other power level can damage both the FP and the power supply.
- Since there is no power switch on the FP unit, be sure to attach a breaker-type switch to its power cord.



- **When the FG terminal is connected, be sure the wire is grounded. Not grounding the FP unit will result in excess noise and vibration.**



- Wherever possible, use thick wires (max.2mm<sup>2</sup>) for power terminals, and twist the wire ends before attaching the ring terminals.
- Be sure to use the following size ring terminals.\*1

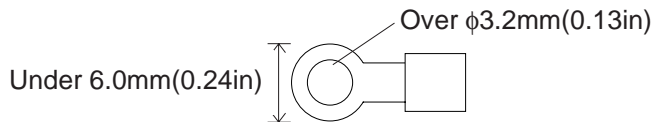

- To avoid a short caused by loose ring terminals, be sure to use ring terminals with an insulating sleeve.

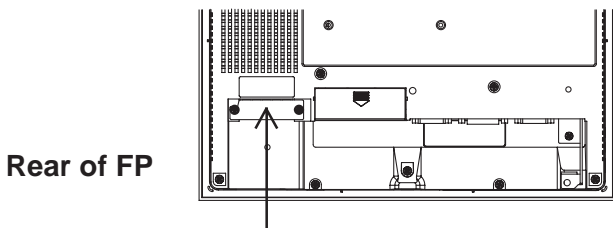

Power Input Terminal Block

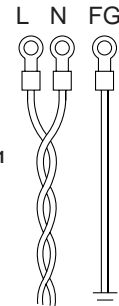
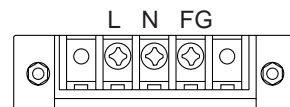

Ring Terminals\*1

### ■ Connecting the AC Power Cord

When connecting the power cord, be sure to follow the procedures given below.

1. Confirm that the FP unit's Power Cord is unplugged from the power supply.
2. Use a screwdriver to remove the Power Input Terminal Block's clear plastic cover.

\*1 Suggested Ring Terminal : equivalent to V2-MS3 (made by JST)

3. Unscrew the screws from the middle three (3) terminals, align the Ring Terminals and reattach the screws.
4. Replace the Power Input Terminal Block's clear plastic cover.



- Confirm that the ring terminal wires are connected correctly.
- The torque required to tighten these screws is 0.5 to 0.6 N•m.

## 7 Power Supply Cautions

### Power Supply Cautions

Please pay special attention to the following instructions when connecting the power cord terminals to the FP unit.

- If the power supply voltage exceeds the FP unit's specified range, connect a voltage transformer.
- Between the line and the ground, be sure to use a low noise power supply. If there is still an excessive amount of noise, connect a noise reducing transformer.
- Input and Output signal lines must be separated from the power control cables for operational circuits.
- The FP unit's power supply cord should not be bundled with or kept close to main circuit lines (high voltage, high current), or input/output signal lines.
- Connect a surge absorber to handle power surges.
- To reduce noise, make the power cord as short as possible.

### Grounding Cautions

- When attaching a wire to the FP unit's rear face FG terminal, (on the AC Connector), be sure to create an exclusive ground.<sup>\*1</sup>

### Input / Output Signal Line Cautions

- All FP Input and Output signal lines must be separated from all operating circuit (power) cables. If this is not possible, use a shielded cable and ground the shield.

---

<sup>\*1</sup> Use a grounding resistance of 100Ω, a wire of 2mm<sup>2</sup> or thicker, or your country's applicable standard.

## 8 Using the USB Cable Strap

### USB Cable Strap Attachment Procedure

- 1) Insert the USB cable into the USB connector.
- 2) Tighten the strap until the cable is secured in place and insert the cable strap into the cable strap holder as shown in the following figure.

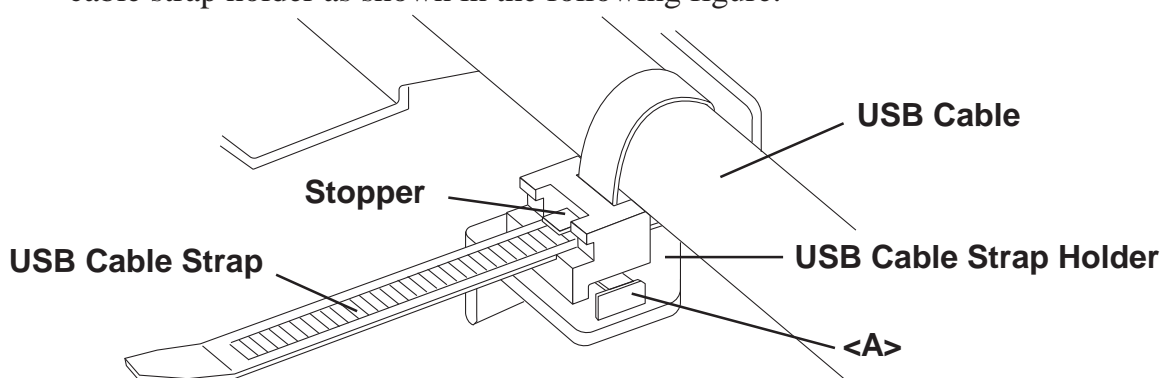

## USB Cable Strap Removal

- 1) Push in the cable strap's stopper with a standard flat-blade screwdriver until the cable strap band unlocks, and remove the strap.
- 2) Disconnect the USB cable.



- If the stopper will not move, press on <A> (shown in figure) to free the strap from the strap holder.

## 9 Screen Display Adjustment

Use the OSD (On screen display) menu to set the FP screen settings, and fine-tune your screen's display.

The following table explains each OSD setting.

"V\*\*\*" : OSD version.

### Main Menu

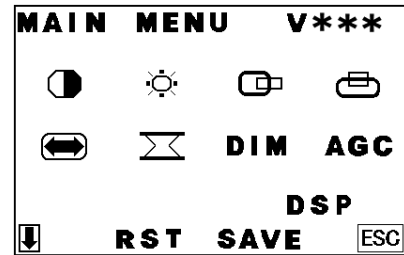

Item	Function	
	CONTRAST	Adjusts the contrast. (Analog RGB only) <sup>*1</sup>
	BLACK LEVEL	Adjusts the color brightness. (Analog RGB only) <sup>*1</sup>
	H-POS	Adjusts the horizontal position of the screen.
	V-POS	Adjusts the vertical position of the screen.
	OSDH-POSITION	Adjusts the screen size in the horizontal direction. (Analog RGB only) <sup>*1</sup>
	PHASE	Adjusts the input signal and the dot clock position. (32 levels) (Analog RGB only) <sup>*1</sup>
<b>DIM</b>	BACKLIGHT	Adjusts the backlight brightness. (9 levels)
<b>AGC</b>	AUTO GAIN CONTROL	Automatically adjusts the contrast and the brightness. (Analog RGB only) <sup>*1</sup>
<b>DSP</b>	DISPLAY MODE	Displays the resolution of the input image data.
<b>RST</b>	OSD CLEAR (RESET)	Resets the current OSD value to the default value.
<b>SAVE</b>	OSD SAVE	Save the current value and quit the OSD.
	SYSTEM	Changes settings such as activating the click sound.
<b>ESC</b>	ESCAPE	Cancels the setting and returns to the upper level. In the main menu, this command closes the OSD.

<sup>\*1</sup> When using DVI-D, the message "DO NOT NEED SETUP FOR DVI-D" is displayed. and no settings are required.

### Starting the OSD

To start the OSD and enter OSD mode, touch the touch panel's corners in the following order : (1) upper left (2) upper right (3) lower right, all within 5 seconds. In OSD mode, the setting screen will appear in the center of the screen. Until OSD setup is completed the touch panel cannot be used to export data to external devices .



- The OSD is not displayed when SW1-2 is set to ON.

## ■ Using the OSD

Icons on the screen are used to operate the OSD. When you start up the OSD, the main menu appears. Touching the icon of the item you want to adjust displays its submenu or setting change screen. In the setting change screen, ◀ and ▶ icons are used to change the setting. To apply the setting, press the **SET** button. Press the **SAVE** button to save the defined settings.

## ■ Quitting the OSD

To quit the OSD, press the **ESC** button in the main menu or level the OSD as it is for at least 30 seconds. If the OSD is automatically closed after 30 seconds of inactivity, the values set before the OSD was closed will be applied.

## ◆ OSD Menu and Operation Tree



### CONTRAST

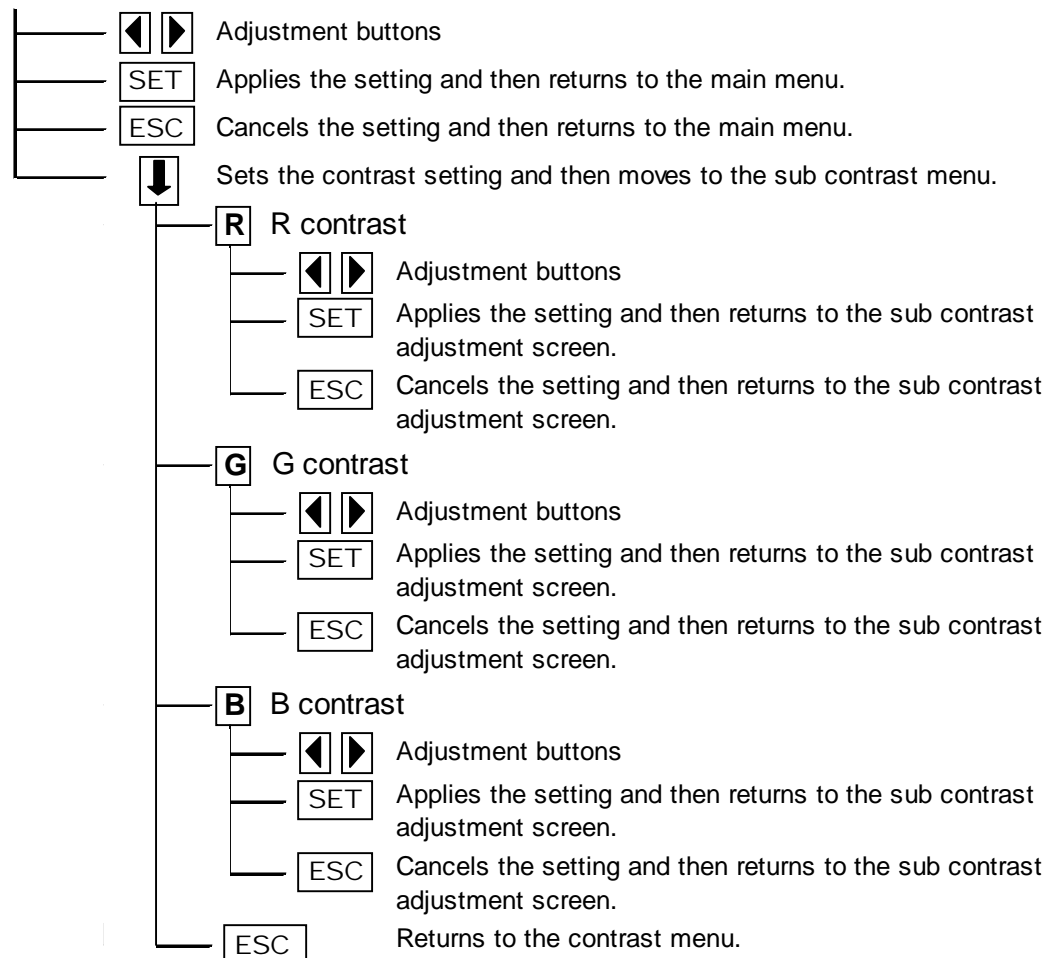

### BLACKLEVEL

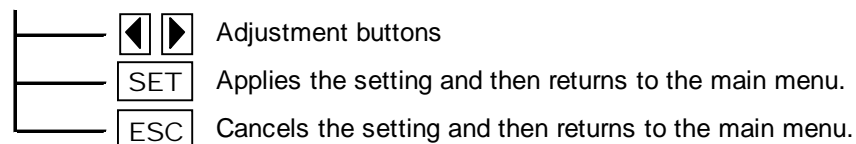

### H-POS

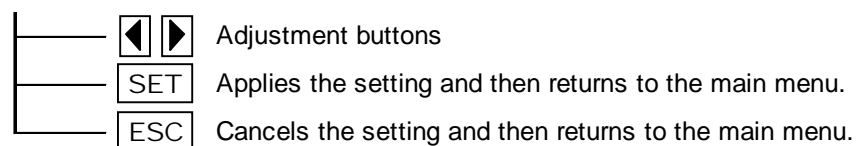

### V-POS

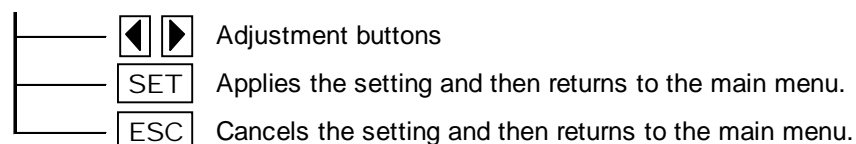



## OSDH-POSITION

- [Left] [Right] Adjustment buttons
- [SET] Applies the setting and then returns to the main menu.
- [ESC] Cancels the setting and then returns to the main menu.



## PHASE

- [Left] [Right] Adjustment buttons
- [SET] Applies the setting and then returns to the main menu.
- [ESC] Cancels the setting and then returns to the main menu.

## DIM

### BACKLIGHT

- [Left] [Right] Adjustment buttons
- [SET] Applies the setting and then returns to the main menu.
- [ESC] Cancels the setting and then returns to the main menu.

## AGC

### AUTO GAIN CONTROL

- [START] Starts the auto gain control and then automatically returns to the main menu.
- [ESC] Returns to the main menu.



- **Be sure to perform the auto gain control when the screen has both 100% black and 100% white areas displayed.**

## DSP

### DISPLAY MODE

- [ESC] Returns to the main menu.

## RST

### OSD CLEAR

- [START] Clears the setting.
- [ESC] Cancels the setting and then returns to the main menu.



## SYSTEM

- [CLICK TONE] Enables/disables the click sound. With this parameter, the sound level can also be adjusted.  
(Default value : OFF <Click sound disabled>)
- [720×400 DSP] When an input data resolution of 720 X 400 is used in the VGA text mode, set this parameter to ON. For other resolutions, set this parameter to OFF.  
(Default : OFF)
- [AUTO OFF DSP] Enables/disables the screen display Auto OFF function and sets the time when the Auto OFF function is enabled.  
(Default : OFF <Auto OFF function disabled>)  
The Auto OFF function automatically turns off the display to prevent the screen from burning out when the touch panel is not used for some period of time. With this parameter, you can set the time interval to turn off the screen display (how much time passes before the screen display is turned off) when the touch panel is not used. If the touch panel is not touched over the set time, the backlight will automatically turns off.  
Select the time period from 1min, 3min, 5min, 10min, and OFF (Auto OFF function disabled).
- [BL ALARM] Enables/disables the Backlight burnout detect function.  
(Default : ON)  
When a burned-out backlight is detected, the status LED flashes alternately green and red, or a steady orange.  
Touch-operation will be disabled when the backlight burns out, which prevents the FP from sending input signals to the PLC.



- **Normally, the FP unit detects a backlight burnout by monitoring the backlight's current flow, however, the FP may fail to detect this condition, depending on the type of backlight problem.**

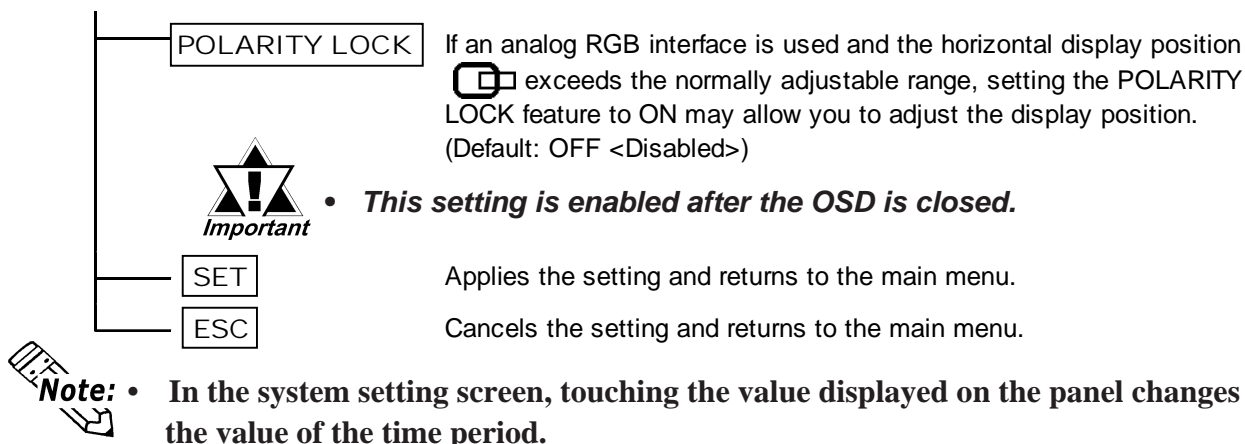

**SAVE** SAVE ————— Saves all the adjusted settings in the EEPROM.



- In the OSD, pressing the **SET** button applies the set value and enables the setting. The set value won't be canceled unless the power is turned OFF or the value is reset. If the power is turned OFF without saving the set value, that data will disappear. The last saved data will be read into the system when the FP starts. To enable the changed value, be sure to press the **SAVE** button.
- When the OSD automatically closes after 30 seconds of inactivity, the set value that you were modifying at the time will be retained. If you quit the OSD with the **ESC** button, the value that you were modifying will be not be retained, Instead, the previously set value will be used.

## 10 Replacing the Backlight

The FP unit's backlight is user replacable.

For an explanation of how to replace the FP unit's backlight, please refer to the FP2500-T12/FP2600-T12 User Manual or the backlight's Installation Guide.

### Corresponding Replacement Backlight Model Numbers

FP Unit	Rev.	Backlight Model
FP2500-T12	-	GP577RT-BL00-MS
FP2600-T12	Rev.1 is not marked	PS600-BU00
	Rev.1 is marked	CA3-BLU12-01



- Use of a different model backlight may cause a FP malfunction or breakdown.
- For FP-2600 Series, the backlight differs depending on a Rev. For the correct backlight and how to distinguish Rev., refer to the User Manual contained in the CD-ROM or carried in the Pro-face Web Site (<http://www.pro-face.com/>).

### Notice

Digital Electronics Corporation shall not be held responsible for any damages or third-party claims for damages or losses resulting from the use of this product.

Digital Electronics Corporation

8-2-52 Nanko Higashi, Suminoe-ku, Osaka 559-0031, Japan

URL: <http://www.pro-face.com/>