

Pro-face

Factory Gateway

User Manual

Preface

Thank you for purchasing the Pro-face Graphic Logic Controller Factory Gateway Series (hereby referred to as “Factory Gateway” or “Factory Gateway unit”).

This unit is designed to be connected to an External Device (PLC, etc.) that do not have their own Ethernet interface, via the Pro-Server system’s Ethernet connection. Pro-Server allows the Factory Gateway unit to communicate with a host-level PC without specialized programming. This allows data collection and sharing of data with other PLC units.

Also, Pro-Server’s Add-on software, GP-Viewer and GP-Web, allow you to access factory floor data from a remote PC, and even perform maintenance.

In this manual’s examples, the Mitsubishi MELSEC-AnA Series PLC is used whenever possible, connected in a one-to-one relationship with a Factory Gateway

< Note >

1. It is forbidden to copy the contents of this manual, in whole or in part, except for the user’s personal use, without the express permission of Digital Electronics Corporation of Japan.
2. The information provided in this manual is subject to change without notice.
3. This manual has been written with care and attention to detail; however, should you find any errors or omissions, contact Digital Electronics Corporation and inform them of your findings.
4. Please be aware that Digital Electronics Corporation shall not be held liable by the user for any damages, losses, or third party claims arising from any uses of this product.

All Company/Manufacturer names used in this manual are the registered trademarks of those companies.

© Copyright 2002 Digital Electronics Corporation

Table of Contents

Preface	1
Essential Safety Precautions	4
General Safety Precautions	7
About Factory Gateway Models	8
Package Contents	8
UL/c-UL (CSA) Application Notes	9
CE Marking Notes	9
Documentation Conventions	10

CHAPTER 1 INTRODUCTION 1-1

1.1 Prior to Operating the Factory Gateway	1-1
1.2 System Design	1-2
1.3 Accessories	1-4

CHAPTER 2 SPECIFICATIONS 2-1

2.1 General Specifications	2-1
2.1.1 Electrical	2-1
2.1.2 Environmental	2-2
2.1.3 Structural	2-2
2.2 Functional Specifications	2-3
2.2.1 Clock	2-3
2.2.2 Interfaces	2-3
2.3 Interface Specifications	2-4
2.3.1 Serial Interface	2-4
2.4 Part Names and Functions	2-6
2.5 Dimensions	2-8

CHAPTER 3 INSTALLATION AND WIRING 3-1

3.1 Installation	3-1
3.2 Wiring Cautions	3-2
3.2.1 Connecting the Power Cord	3-2
3.2.2 Connecting the Power Supply	3-4
3.2.3 Grounding	3-5
3.2.4 I/O Signal Line Cautions	3-6
3.3 Tool Connector	3-6
3.4 Ethernet Cable Connector	3-7

3.5 IP Address Settings 3-7
3.6 Dip Switch Settings 3-8
 3.6.1 Initializing Memory 3-9

CHAPTER 4 TROUBLESHOOTING 4-1

4.1 Troubleshooting 4-1
 4.1.1 LED Status Indicators 4-2
 4.1.2 Problem Solving 4-4
4.2 Periodic Check Points 4-5

Essential Safety Precautions

This manual includes procedures that must be followed to operate the FACTORY GATEWAY correctly and safely. Be sure to read this manual and any related materials thoroughly to understand the correct operation and functions of the FACTORY GATEWAY unit.

■ Safety Symbols

Please pay attention to the following safety symbols and their meanings:



Indicates situations that may result in major machine damage, severe bodily injury, or death if the instructions are not followed.



Indicates situations that may result in damage to the machinery, or minor bodily injury if the instructions are not followed.

WARNINGS

System Design

- **Please design your system so that equipment will not malfunction due to a communication fault between the Factory Gateway and its host controller. This is to prevent any possibility of bodily injury or material damage.**
- **Do not use the Factory Gateway unit as a warning device for critical alarms that can cause serious operator injury, machine damage or production stoppage. Critical alarm indicators and their control/activator units must be designed using stand-alone hardware and/or mechanical interlocks.**
- **The Factory Gateway is not appropriate for use with aircraft control devices, aerospace equipment, central trunk data transmission (communication) devices, nuclear power control devices, or medical life support equipment, due to these devices' inherent requirements of extremely high levels of safety and reliability.**

 **WARNINGS**

- When using the Factory Gateway with transportation vehicles (trains, cars and ships), disaster and crime prevention devices, various types of safety equipment, non life-support related medical devices, etc. redundant and/or fail-safe system designs should be used to ensure the proper degree of reliability and safety.

Installation

- High voltage runs through the Factory Gateway. Never disassemble the Factory Gateway, otherwise an electric shock can occur.
- Do not modify the Factory Gateway unit. Doing so may cause a fire or an electric shock.
- Do not use the Factory Gateway in an environment where flammable gasses are present, since operating the Factory Gateway may cause an explosion.

Wiring

- To prevent an electric shock, be sure to confirm that the Factory Gateway's power cord is not connected to the main power when connecting any cords, cables or lines to the Factory Gateway.
- Be sure to replace the Factory Gateway's plastic terminal block cover after wiring is completed, since operating the Factory Gateway without the cover may lead to an electric shock.
- Do not use power beyond the Factory Gateway's specified voltage range. Doing so may cause a fire or an electric shock.

Maintenance

- The Factory Gateway uses a lithium battery for backing up its internal clock data. If the battery is incorrectly replaced, the battery may explode. To prevent this, please do not replace the battery yourself. When the battery needs to be replaced, please contact your local Factory Gateway distributor.



CAUTIONS

Installation

- Be sure to securely connect all cable connectors to the Factory Gateway. A loose connection may cause incorrect input or output.

Wiring

- Ground the Factory Gateway's FG line separately from other units' FG lines. Putting these FG lines too close may cause an electric shock or unit malfunction. Be sure to use a grounding resistance of 100Ω or less and a 2mm^2 or thicker wire, or your country's applicable standard.
- When wiring the Factory Gateway, be sure that the rated voltage and terminal layout are within the designated range. If the voltage supplied differs from the rated voltage, or incorrect wiring or grounding is performed, it may cause a fire or unit malfunction.
- Use only the designated torque to tighten the Factory Gateway's terminal block screws. If these screws are not tightened firmly, it may cause a short-circuit, fire, or Factory Gateway malfunction.
- Be careful that metal filings and wiring debris do not fall inside the Factory Gateway, since they can cause a fire, Factory Gateway malfunction, or incorrect operation.

Unit Disposal

- When this unit is disposed of, it should be done so according to your country's regulations for similar types of industrial waste.

General Safety Precautions

- Do not install the Factory Gateway where the ambient temperature can exceed the allowed range. Doing so may cause the Factory Gateway to malfunction or shorten its operation life.
- Do not restrict or limit the Factory Gateway's naturally occurring rear-face ventilation, or store or use the Factory Gateway in an environment that is too hot.
- Do not use this unit in areas where large, sudden temperature changes can occur. These changes can cause condensation to form inside the unit, possibly causing the unit to malfunction.
- Do not allow water, liquids, metal or charged particles to enter inside the Factory Gateway's case, since they can cause either a Factory Gateway malfunction or an electrical shock.
- Do not use or store the Factory Gateway in direct sunlight, or in excessively dusty or dirty environments.
- Do not store or use the unit where strong jolting or excessive vibration can occur.
- Do not store or use the Factory Gateway where chemicals (such as organic solvents, etc.) and acids can evaporate, or where chemicals and acids are present in the air.
Corrosive chemicals: Acids, alkalies, liquids containing salt
Flammable chemicals: Organic Solvents
- Do not use paint thinner or organic solvents to clean the Factory Gateway.

About Factory Gateway Models

The Factory Gateway Series in this manual refers to the following Factory Gateway model numbers:

Series Name	Model Number	Comments	GP Type with Screen Creation Software
Factory Gateway	FGW-SE41-24V	UL/c-UL Approved CE Marked	Factory Gateway FGW-SE

Package Contents

The following items are included in the Factory Gateway's package. Before using the Factory Gateway, please confirm that all items listed here are present.

■ **Factory Gateway Unit (1)**
(FGW-SE41-24V)

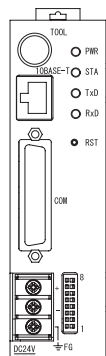

■ **Installation Guide (1)**



This unit has been carefully packed, with special attention to quality. However, should you find anything damaged or missing, please contact your local Factory Gateway distributor immediately.

UL/c-UL (CSA) Application Notes

The FGW-SE41-24V is a UL/c-UL (CSA) listed product. (UL File No. E220851)

The FGW-SE41-24V unit conforms to the following standards.

- UL508 Electrical Control System for Industry
- CAN/CSA-C22.2 No.1010-1
(Safety requirements for electrical equipment for measurement and laboratory use)
FGW-SE41-24V (UL Registration Model: 3080034-01)

<Notes>

- The Factory Gateway must be installed in other equipment.
- If the unit is installed in an area with no air conditioning system, be sure to attach the DIN rail to the rear of the unit. Also, be sure the unit is installed so it is at least 100 mm away from all of the unit's directions except the rear side. If these requirements are not met, the heat generated by the unit's internal components may cause the unit to fail to meet UL standards requirements.
- The power supply unit connected to the I/O unit must be a UL/c-UL (CSA) approved Class 2 power supply unit or Class 2 transformer*1. When the Factory Gateway or multiple I/O units under load are operated with a single power supply, the amount of current consumption and full-load current of the I/O units must be within the rated load of the Class 2 power supply unit or Class 2 power supply transformer. Be aware that the number of points which can be turned ON simultaneously may be limited, depending on the amount of load and load current value.

*1 A Class 2 power supply unit or Class 2 power supply transformer is C as being 30V and, at 8A or less output, less than 100VA. (defined by National Electorical Code)

CE Marking Notes



The FGW-SE41-24V is a CE Marked unit that conforms to EMC directives EN55011 Class A and EN61000-6-2.

<Caution>

While this unit is officially marked as conforming to the relevant EMC directives, it is the user's final application of this unit in a larger system (i.e. the machinery, wiring, control panel, installation method, etc.) that will determine if this unit maintains or loses this conformance marking. Therefore, it is strongly advised that the user investigate and confirm whether their overall system (i.e. all related machinery and equipment) also conforms with these EMC directives.

Documentation Conventions

The list below describes the documentation conventions used in this manual.

Symbol	Meaning
	Indicates important information or procedures that must be followed for correct and risk-free software/device operation.
Data Collection Software	Indicates the "Pro-Server with Pro-Studio for Windows" software. Pro-Server is used as a server, and Pro-Studio is used as a data set up tool.
Factory Gateway Configuration Tool	Used to set up and send protocol data to the Factory Gateway unit. (sold as optional Add-on software)
Screen Creation Software	Indicates the "GP-PRO/PBIII for Windows" software. GP-PRO/PBIII for Windows is also included in the "GP-PRO/PBIII C-Package" software. Intended primarily for the creation and maintenance of operator interface (GP unit) screens, it can also create screens for GP-Viewer and GP-Web.
GP Viewer	Pro-Server uses this add-on software to display and sample screens created using the Screen Creation Software.
GP-Web	This add-on software displays screens created using the Screen Creation Software, using the Internet Explorer software.
PLC	Abbreviation for Programmable Logic Controller.
2-Way	This driver software is used as a protocol converter between external devices (PLCs, etc.) and PCs, Factory Gateway, GP and GLC series units.
*	Indicates additional important information.
	Indicates an important hint or explanation.

Chapter 1 Introduction

1. Prior to Operating the Factory Gateway
2. System Design
3. Accessories

1.1 Prior to Operating the Factory Gateway

Use the following steps to create projects for the Factory Gateway unit.

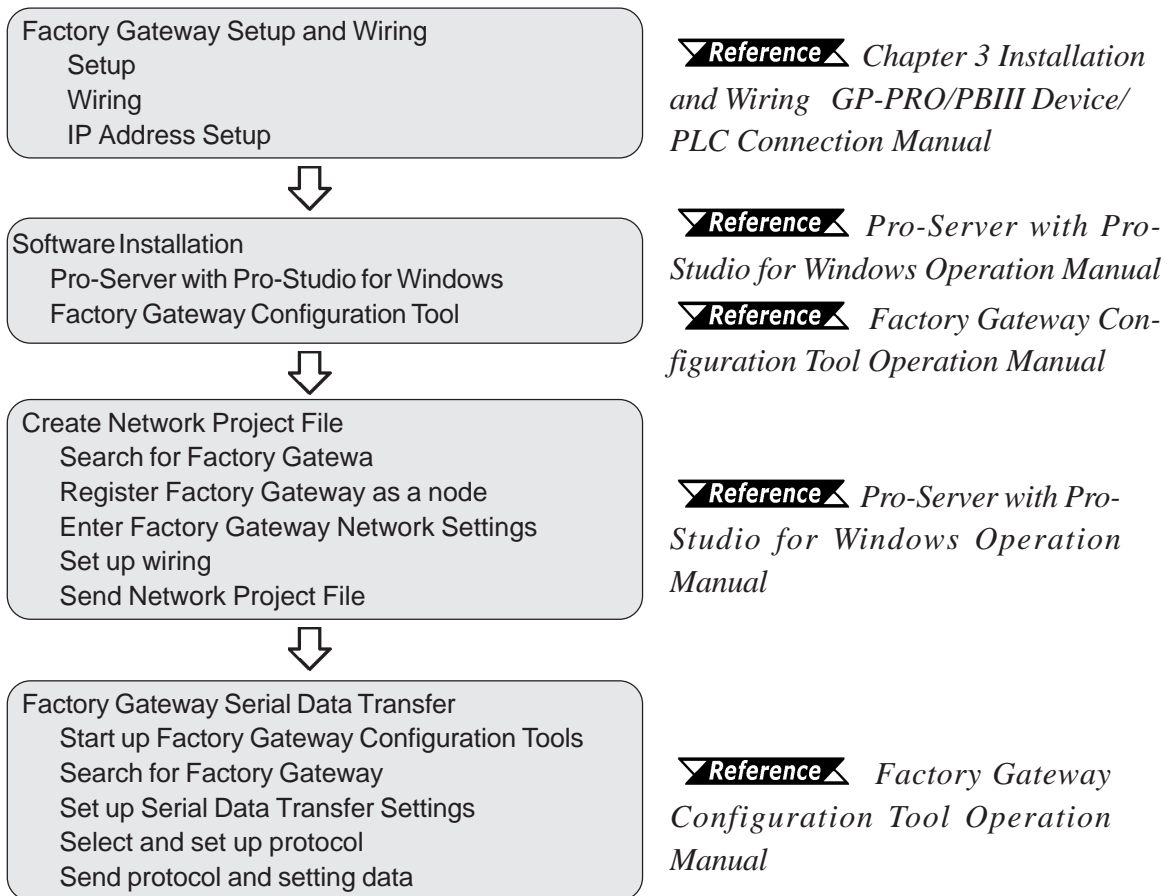

Note:

When using GP-Web or GP-Viewer, screen creation software must first be installed, screens created and data sent to the Factory Gateway unit.

▼ **Reference** ▲ *Factory Gateway Configuration Tool Operation Manual*

This manual explains the hardware settings used to set up the Factory Gateway unit. For detailed information about operation of the Factory Gateway Configuration Tool, or Pro-Server with Pro-Studio for Windows, please refer to the following manuals



▼ **Reference** ▲ *Factory Gateway Configuration Tool Operation Manual*

▼ **Reference** ▲ *Pro-Server with Pro-Studio for Windows Operation Manual*

1.2 System Design

The following diagram represents the main selection of devices connectable to the Factory Gateway unit.

■ Factory Gateway RUN Mode Peripherals

RUN Mode 
 Edit Mode 

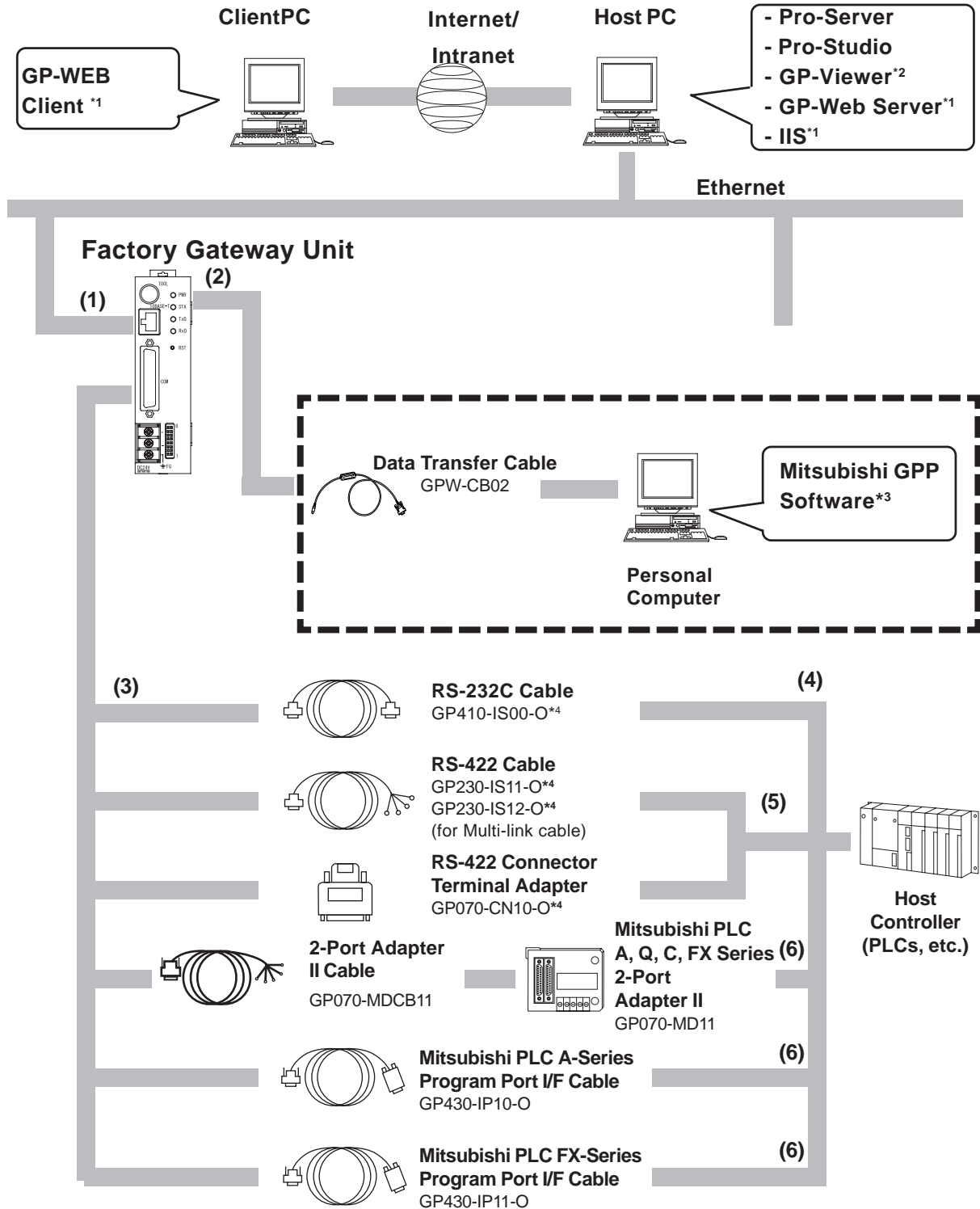

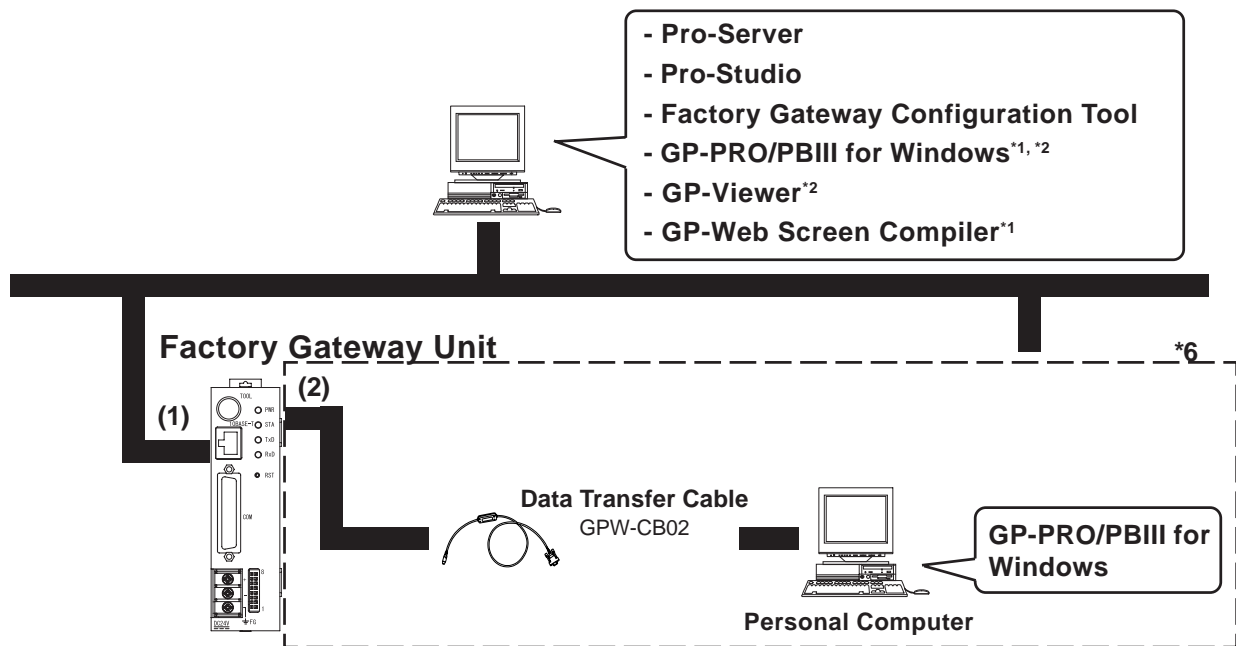

Factory Gateway Interfaces	PLC Interfaces
(1) Ethernet	(4) RS-232C Port
(2) Tool Connector	(5) RS-422 Port
(3) Serial Interface	(6) Programming Console Port

1. Required when using GP-Web.
2. Required when using GP-Viewer
3. **Reference** For information about compatible PLC types and software, refer to the **GP-PRO/PB III for Windows Device/PLC Connection Manual** (included in the GP-PRO/PB III software).
4. Certain PLC types and models cannot be connected.
 - Reference** Refer to the **GP-PRO/PB III for Windows Device/PLC Connection Manual** (included in the GP-PRO/PB III software).
5. For the full range of compatible PCs, refer to the following manual.
 - Reference** Refer to the **GP-PRO/PB III for Windows Operation Manual** (included in the GP-PRO/PB III software).
6. Normally, maintenance (data transfer) is possible using an Ethernet network. However, depending on the data transfer cable used, a Factory Gateway System Error may occur, preventing communication.

1.3 Accessories

All optional equipment listed here is produced by Digital Electronics Corporation.

■ Available Software

Product Name	Model No.	Description
Pro-Server with Pro-Studio for Windows Ver. 4.0	PSW-ED01-V40	This software is used to set up the Pro-Server System. This software consists of 2 elements, a server (Pro-Server) and a setting entry program (Pro-Studio). (Required)
Factory Gateway Configuration Tool ^{*1}	_____	Used to set up and send protocol data to the Factory Gateway unit. Add-on software for Pro-Server. (Required)
GP-PRO/PBIII for Windows Ver. 6.0 or later ^{*2*3*4}	GPW-PB01W-V60	Used to create projects and screen data that can be sent to the Factory Gateway and then displayed using GP-Viewer or GP-Web. Depending on the cable used, serial data transfer can also be used.
GP-Viewer 1.0 or later ^{*3}	PSW-GV01-V10	Installed in the Pro-Server PC and used to view or perform maintenance on data in a PLC that is connected to the Factory Gateway unit. (Add-on Software)
GP-Web Ver. 1.5 or later ^{*4}	GW-CJ01-V15	Used to create or maintain PLC device data that can be viewed with Internet Explorer software. This data is taken from a PLC (device) that is connected to the Factory Gateway unit. GP-Web system includes server, client and GP-PRO/PBIII software.

■ Tool Connector

Product Name	Model No.	Description
Data Transfer Cable	GPW-CB02	Connects the Factory Gateway to a personal computer. Transfers screen data and user programs.

1. Installed from Pro-Server with Pro-Studio for Windows CD-ROM. With Ver. 4.0* CD-ROMs, this software may not be included. In this case, please download the software from the www.pro-face.com home page.
2. With Ver. 6.0*, add-on software is required. Please download this software from the www.pro-face.com home page.
3. Required when using GP-Viewer
4. Required when using GP-Web.
5. Normally, maintenance (data transfer) is possible using an Ethernet network. However, depending on the data transfer cable used, a Factory Gateway System Error may occur, preventing communication.

■ Serial Interfaces

Product Name	Model No.	Description
RS-232C Cable ^{*1}	GP410-IS00-O	Interface cables between the host (PLC) and the Factory Gateway.
RS-422 Cable ^{*1}	GP230-IS11-O	
RS-422 Terminal Block Adapter ^{*1}	GP070-CN10-O	Conversion adapter to convert serial data to RS-422 format.
2 Port Adapter II	GP070-MD11	Interface unit that allows use of both Factory gateway and Mitsubishi A, Q, C and FX series equipment in the same location.
2 Port Adapter II Cable	GP070-MDCB11	Connects the Factory Gateway to the 2-Port Adapter II.
Mitsubishi A Series Programming Port I/F Cable	GP430-IP10-O	Connects directly to Mitsubishi's PLC I/F Programming Console. Simultaneous use of program console, however, is not possible.
Mitsubishi FX Series Programming Port I/F Cable	GP430-IP11-O	

1. For details about the range of connectable PLCs:

Reference Refer to the *GP-PRO/PB III for Windows Device/PLC Connection Manual* (included with the GP-PRO/PB III software).

■ Maintenance Items

Product Name	Model No.	Description
Connector Cover	PS-BH00	Side face connector cover.

Memo

Chapter

2 Specifications

1. General Specifications
2. Functional Specifications
3. Interface Specifications
4. Part Names and Functions
5. Dimensions

2.1 General Specifications

2.1.1 Electrical

Rated Voltage	DC 24V
Rated Voltage Range	DC 19.2V to DC 28.8V
Allowable Voltage Drop	10ms max.
Power Consumption	10W max.
In-Rush Current	30A max.
Voltage Endurance	AC 500V 20mA for 1 minute (between charging and FG terminals)
Insulation Resistance	10M Ω or more at DC 500V (between charging and FG terminals)

Chapter 2 – Specifications

2.1.2 Environmental

Ambient Operating Temperature	0°C to +55°C
Storage Temperature	-20°C to +60°C
Ambient Humidity	10%RH to 90%RH (non-condensing, wet bulb temperature: 39°C max.)
Storage Humidity	10%RH to 90%RH (non-condensing, wet bulb temperature: 39°C max.)
Air Purity (Dust)	0.1mg/m ³ max. (non-conductive levels)
Atmosphere	Free of corrosive gasses
Atmospheric Endurance (GLC Operation Altitude)	800hPa to 1,114hPa (2000 meters max.)
Shock Resistance	IEC61131-2 (JIS B 3501) compliant (147m/s ² , three times for each [X, Y, Z] direction)
Vibration Resistance	IEC61131-2 (JIS B 3501) compliant When Vibration is NOT Continuous 10Hz to 57Hz 0.075mm, 57Hz to 150Hz 9.8m/s ² When Vibration is Continuous 10Hz to 57Hz 0.035mm, 57Hz to 150Hz 4.9m/s ² (10 times [80 min.] for each [X, Y, Z] direction)
Noise Immunity (via noise simulator)	Noise Voltage: 1200Vp-p, Pulse Duration: 1μs Rise Time: 1ns
Electrostatic Discharge Immunity	Contact Discharge Method 6kV (complies with IEC 61000-4-2 Level 3)

2.1.3 Structural

Grounding	100Ω max., or your country's applicable standard
External Dimensions	W37mm x H131mm x D105mm [1.46 in.x 5.16 in. x 4.13 in.]
Weight	Approx. 0.6 kg [1.32 lb]
Cooling Method	Natural air circulation

2.2 Functional Specifications

2.2.1 Clock

Clock Accuracy	±65 seconds/month (at room temperature)
-----------------------	---



Note: The FACTORY GATEWAY unit's internal clock has a slight error. At normal operating temperatures and conditions, with the FACTORY GATEWAY operating from its lithium battery, the degree of error is 65 seconds per month. Variations in operating conditions and battery life can cause this error to vary from -380 to +90 seconds per month. For systems where this degree of error will be a problem, the user should be sure to monitor this error and make adjustments when required.

Reference See *Factory Gateway Configuration Tool Operation Manual.*

2.2.2 Interfaces

Serial Interface	Asynchronous Transmission: RS232C/RS422 Data Length: 7 or 8 bits Stop Bit: 1 or 2 bits Parity: None, Odd or Even Data Transmission Speed: 2,400 to 187,500bps
Ethernet Interface	IEEE802.3, 10BASE-T
Tool Connector	Asynchronous TTL level nonprocedural command I/F <During screen file development> Used for transferring data between the GLC application software and the GLC. Used for data transfer with the 2-Port feature.

2.3 Interface Specifications

2.3.1 Serial Interface

This interface can be either RS-232C or RS-422. Connects FACTORY GATEWAY to Host (PLC). This interface uses a socket-type connector.

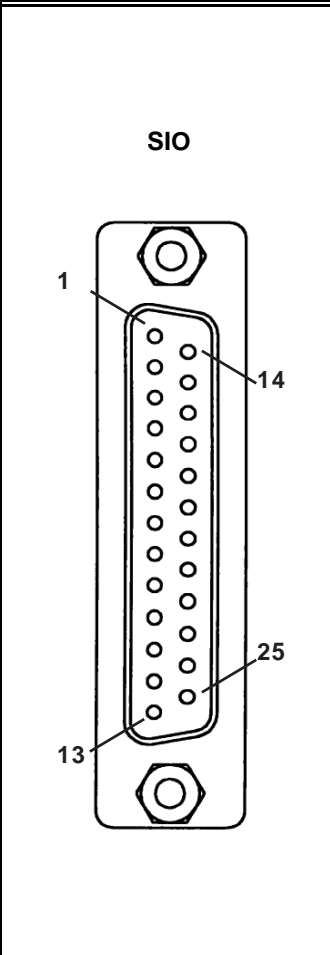
Pin Assignments	Pin #	Signal Name	Condition
	1	FG	Frame ground
	2	SD	Send data (RS-232C)
	3	RD	Receive data (RS-232C)
	4	RS	Request send (RS-232C)
	5	CS	Clear send (RS-232C)
	6	DR	Data Set Ready (RS-232C)
	7	SG	Signal ground
	8	CD	Carrier detect (RS-232C)
	9	TRMX	Termination (RS-422)
	10	RDA	Receive data A (RS-422)
	11	SDA	Send data A (RS-422)
	12	NC	No connection (Reserved)
	13	NC	No connection (Reserved)
	14	VCC	5V±5% output 0.25A
	15	SDB	Send data B (RS-422)
	16	RDB	Receive data B (RS-422)
	17	RI	Ring Indicate (RS-232C)
	18	CSB	Clear send B (RS-422)
	19	ERB	Enable receive B (RS-422)
	20	ER	Enable receive (RS-232C)
	21	CSA	Clear send A (RS-422)
	22	ERA	Enable receive A (RS-422)
	23	NC	No connection (Reserved)
	24	NC	No connection (Reserved)
	25	NC	No connection (Reserved)

Recommended Parts

Connector	Dsub25pin plug	XM2A-2501	(OMRON)
Cover	Dsub25pin cover	XM2S-2511	(OMRON)
	Dsub25pin cover	XM2S-2521	(OMRON)
	Jack Screws	XM2Z-0071	(OMRON)
Cable	CO-MA-VV-SB5PX 28AWG		(Hitachi Cable Ltd.)



Use rough metric type M2.6x0.45 p threads used to secure the cable's set screws.

Reference To confirm your PLC unit's connection specifications, refer to the *GP-PRO/PB III for Windows Device/PLC Connection Manual* (included in the GP-PRO/PB III C-Package01).

Chapter 2 – Specifications



Use the following instructions to create your own cable:

With an RS-422 cable:

- The following pins must be shorted as follows:
 - #18 (CSB) and #19 (ERB)
 - #21 (CSA) and #22 (ERA)
- Connecting the RS-422 cable's #9 (TRMX) and #10 (RDA) pins inserts a termination resistance of 100Ω between #10 (RDA) and #16 (RDB).
- When making a cable for a Memory Link system, use a 4-wire type cable.

With an RS-232C cable:

- Do NOT use the following pins:
 - #9 (TRMX), #10 (RDA), #11 (SDA), #15 (SDB), #16 (RDB), #18 (CSB), #19 (ERB), #21 (CSA), #22 (ERA)
- Connect the #1 (FG) terminal only if it is required by a connected device.



-
- **This FACTORY GATEWAY unit's serial port is not isolated. When the host (PLC) unit is also not isolated, and to reduce the risk of damaging the RS-422 circuit, be sure to connect the #7 SG (Signal Ground) terminal.**
 - **Pin #14 (VCC) DC 5V Output is not protected. To prevent damage or unit malfunction, use only the designated level of current.**
 - **The SG and FG terminals are connected internally in the Factory Gateway unit.**
 - **When connecting the SG line to another device, be sure that the design of the system / connection does not produce a shorting loop.**
-

2.4 Part Names and Functions

A : Tool Connector

Connects the data transfer cable when transferring data for maintenance or when using 2-Port feature.

B : Ethernet I/F(10BASE-T)

Provides a 10BASE-T interface.

C : Network Status LED

These LEDs are positioned vertically and indicate the Ethernet data transfer status.

Location	Color	Indicates	Not Lit Indicates
Upper	Green	Ready to transfer data	Not connected to network / Network trouble
Lower	Yellow	Transferring data	Not transferring data

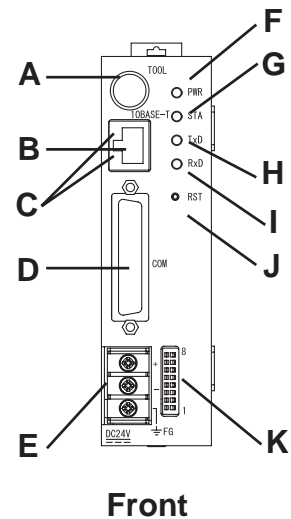

D : Serial I/F(Dsub 25pin)

Used for the Dsub25 pin's RS-232C and RS-422 cables. Is connected to the Host (PLC.)

Reference 2.3 Interface Specifications

E : Power Input Terminal Block

Connects the power cord.

F : Power LED (PWR)

This LED indicates the Factory Gateway's status.

LED	Factory Gateway Status
Green	Normal operation
Red	Initializing internal memory
Orange	Data transfer (OFFLINE) mode
Not Lit	System program error

G : Error Status LED (STA)

LED	Factory Gateway Status
Green	Normal operation
Red	System error / Screen memory data is damaged
Orange	2-Way feature error
Not Lit	System Program Error

Reference For details, see 4.1.1 LED Status Indicators

Chapter 2 – Specifications

H : Serial I/F (Tx/D)

When this indicator blinks, data is being sent.

I : Serial I/F (Rx/D)

When this indicator blinks, data is being received.

J : Reset Switch (RST)

Resets the Factory Gateway unit.

K :DIP Switches

Control various Factory Gateway features.

Factory settings are all “OFF”.

Reference For details, see 3.6 Setting Dip Switches

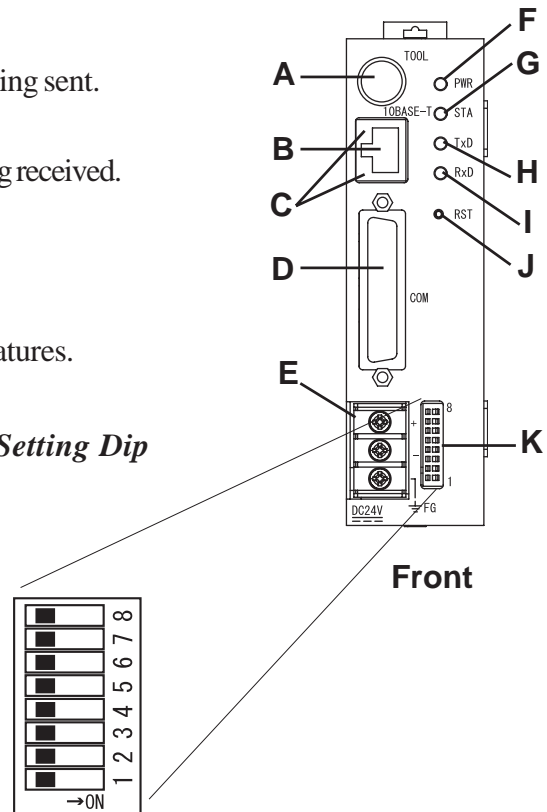

L : DIN Rail Attachment Holder

M: Rotary Switches

These switches are used to set the unit’s IP Address. The factory settings are “0”.

Reference For details, see 3.5 Setting IP Addresses

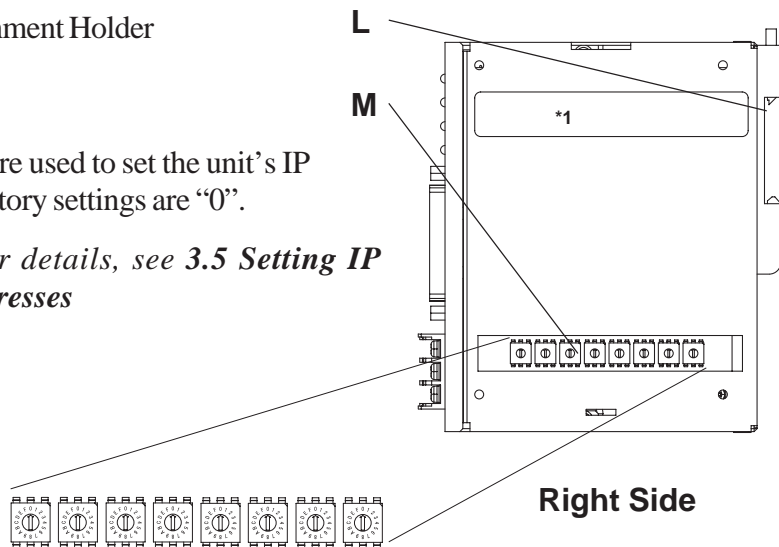

*1 This section is used only for maintenance by Pro-face. Do not open this cover.

2.5 Dimensions

Unit:mm [in.]

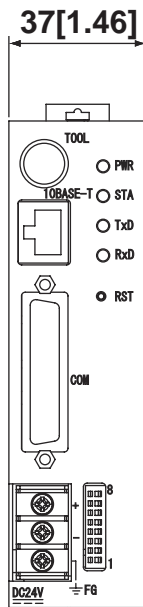

Front

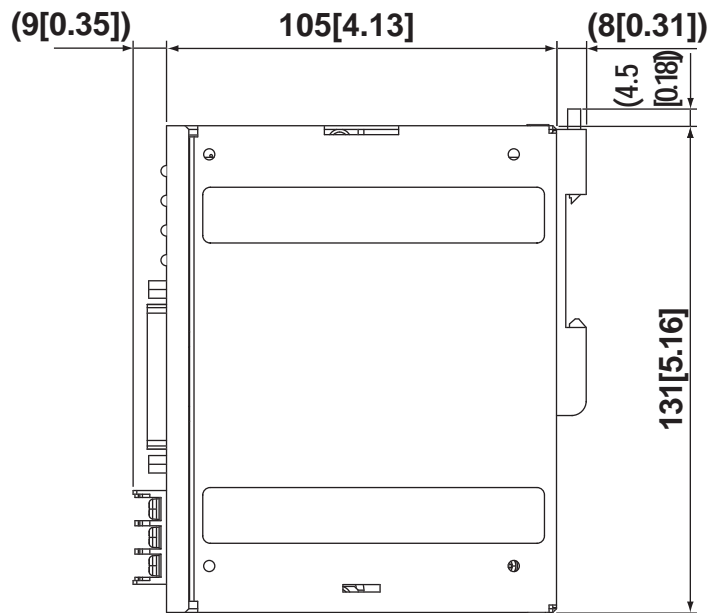

Right Side

Chapter

3 Installation and Wiring

1. Installation
2. Wiring Cautions
3. Tool Connector
4. Ethernet Cable Connector
5. IP Address Settings
6. Dip Switch Settings

3.1 Installation

The following information explains how to attach a 35mm DIN rail to the Factory Gateway.

◆ Attachment

Place the unit's curved, bottom lip over the bottom of the DIN rail, and tilt the unit up until the top face attachment clip clicks into place.

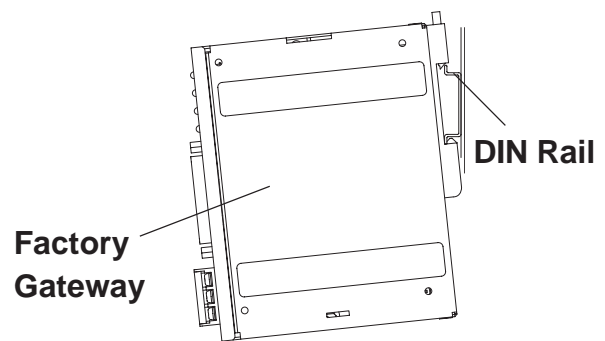

Important

- Be sure that the top and bottom faces of the unit are correctly oriented and that the unit is vertical. Incorrect installation may prevent heat from dissipating correctly.
- When removing the unit from the attachment clips, hold the unit with your hand to prevent it from falling. To prevent the Factory Gateway unit from being dislodged from the DIN Rail due to being struck or bumped from the side, the following Stabilizer Clips are recommended.

BNL5P (IDEC Corporation)

HDV-1 (TOYO GIKEN Corporation)

◆ Removal

Use a standard screwdriver to force the unit's attachment clip up until the top of the unit is freed from the rail. Next, tilt the unit down and remove.

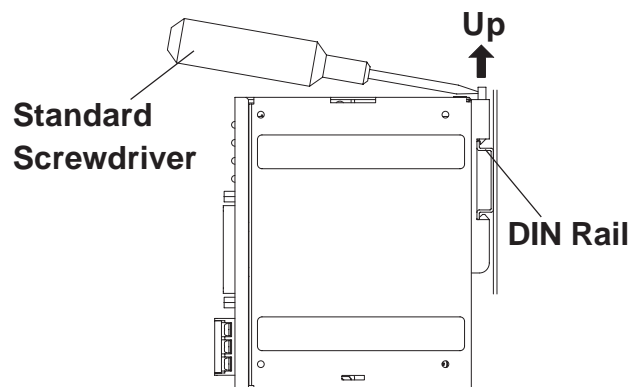

Important

When removing the unit from the attachment clips, hold the unit with your hand to prevent it from falling.

3.2 Wiring Cautions

3.2.1 Connecting the Power Cord

WARNINGS

- To avoid an electric shock, be sure the power cord is unplugged from the power supply when connecting the power terminals to the Factory Gateway unit.
- The Factory Gateway FGW-SE41-24V unit is designed to use only with DC24V power. Using any other level of power can damage both the power supply and Factory Gateway unit.
- Since there is no power switch on the Factory Gateway unit, be sure to attach a breaker type switch to its power cord.
- When the FG terminal is connected, be sure the wire is grounded. Otherwise, an electric shock can occur when the unit is broken.



- To prevent the Ring Terminals from short-circuiting when the terminal block attachment screws are loosened, use sleeve-type Ring Terminals.
- When the FG terminal is connected, be sure that the wire is grounded. Not grounding the Factory Gateway unit will result in excessive noise. Use your country's applicable standard for grounding.
- The SG and FG terminals are connected internally in the Factory Gateway unit.
- When connecting the SG line to another device, be sure that the design of the system / connection does not produce a shorting loop.



- Wherever possible, use thick wires (max. 2 mm²) for power terminals, and twist the wire ends before attaching the ring terminals.
- Be sure to use the following size ring terminals.*¹

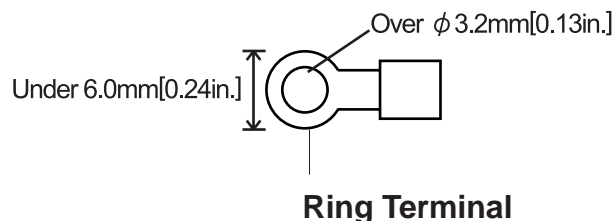

*¹ Suggested Ring Terminal : V2-MS3 (made by JST)

Chapter 3 – Installation and Wiring

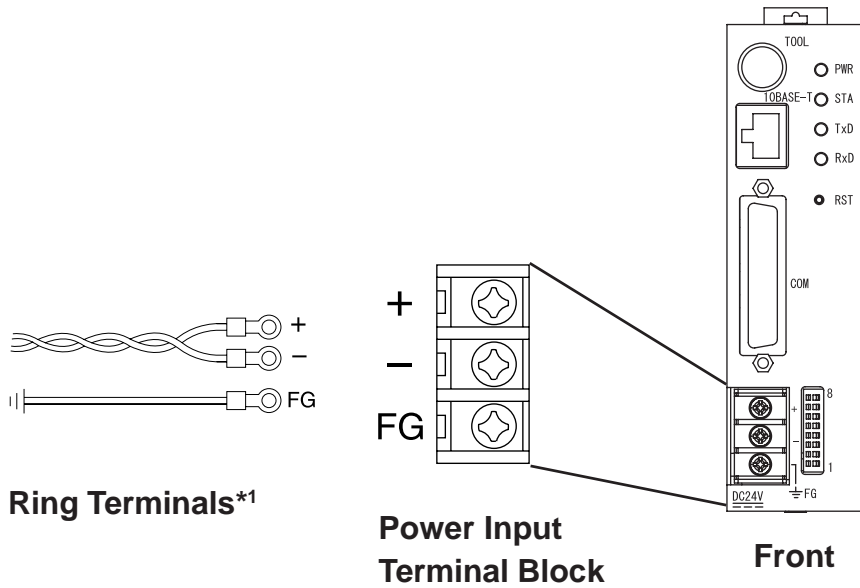

+	Positive Electrode
-	Negative Electrode
FG	Groundin terminal connected to Factory Gateway chassis

When connecting the power cord, be sure to follow the procedures given below.

1. Confirm that the Factory Gateway unit's Power Cord is unplugged from the power supply.
2. Use a screwdriver to remove the Power Input Terminal Block's clear plastic cover.
3. Remove the screws from the middle three (3) terminals, align the Ring Terminals and reattach the screws.

Reference See 3.2.2 Connecting the Power Supply



- Confirm that the wires are connected correctly.
- The torque required to tighten these screws is 0.5 to 0.6 N•m.

4. Replace the Power Input Terminal Block's clear plastic cover.

*1 Suggested Ring Terminal : V2-MS3 (made by JST)

Chapter 3 – Installation and Wiring

3.2.2 Connecting the Power Supply

- When supplying power to the Factory Gateway unit, separate the input/output and operation unit lines (see Diagram 1).
- To increase the noise resistance quality of the power cord, twist each power wire before attaching the Ring Terminal.
- The power supply cord must not be bundled or positioned close to main circuit lines (high voltage, high current), or input/output signal lines (see Diagram 2).
- Connect a lightning surge absorber (see Diagram 3) to deal with power surges.
- To avoid excess noise, make the power cord as short as possible.



- **Ground the surge absorber (E1) separately from the Factory Gateway unit (E2).**
- **Select a surge absorber with a maximum circuit voltage that is greater than that of the power supply's peak voltage.**

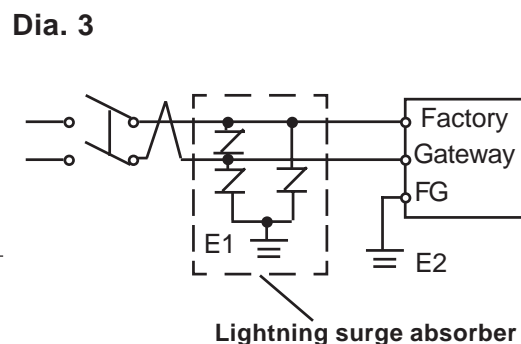
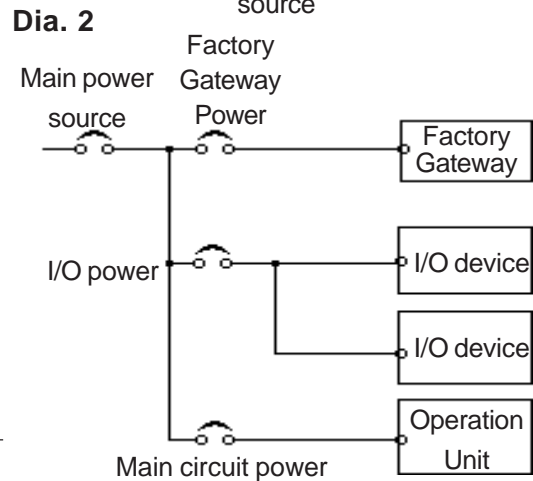
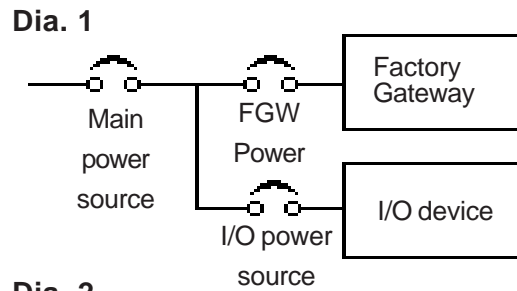

3.2.3 Grounding



CAUTION

Do NOT use common grounding, since it can lead to an accident or machine breakdown.

Connect the FG terminal found on the back of the Factory Gateway unit to an exclusive ground (diagram A).

(A) Excluding Grounding (BEST)



- Make sure that the grounding resistance is less than 100Ω.
- The FG and SG lines are connected internally in the Factory Gateway.
- When connecting the SG line to another device, be sure that the design of the system / connection does not produce a shorting loop.
- The grounding wire should have a cross-sectional area of at least 2 mm². Create the grounding point as close to the Factory Gateway unit as possible, and keep the wire as short as possible. Replace thin wire with a thicker wire, and place it in a duct.

If exclusive grounding is not possible, use a common connection point (diagram B).

(B) Common Grounding (OK)

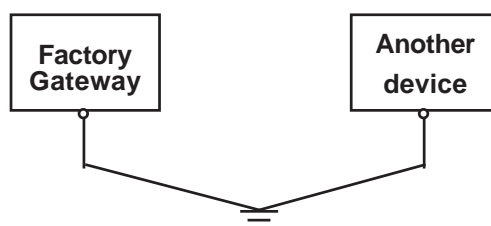

(B) Common Grounding (Not OK)

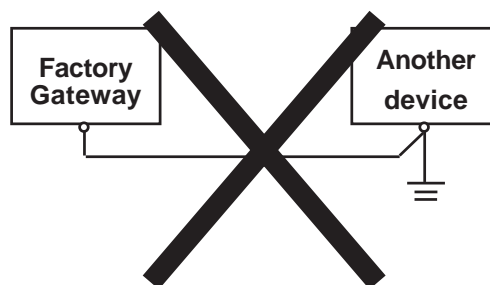

If the equipment does not function properly when grounded, disconnect the ground wire from the FG terminal.

Chapter 3 – Installation and Wiring

3.2.4 I/O Signal Line Cautions

- To help prevent noise and interference problems, separate all communication lines from power lines by placing them in a separate duct.
- If different wires must be placed in the same duct, separate them with an earthed/grounded divider.

3.3 Tool Connector

A data transfer cable can be attached to the Factory Gateway unit's tool connector. The location of the Factory Gateway unit's tool connector is shown in the following diagram.

 **WARNINGS**

To prevent an electrical shock, be sure to unplug the Factory Gateway unit's power cord from the main power supply prior to attaching or detaching any connectors to or from the Factory Gateway.

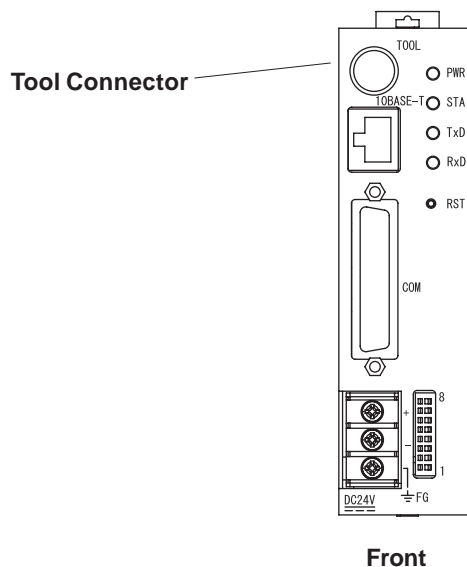

3.4 Ethernet Cable Connector

The Factory Gateway Ethernet interface is IEEE802.3 compliant, and transmits data at 10 Mbps. The Ethernet connector's location is shown below.

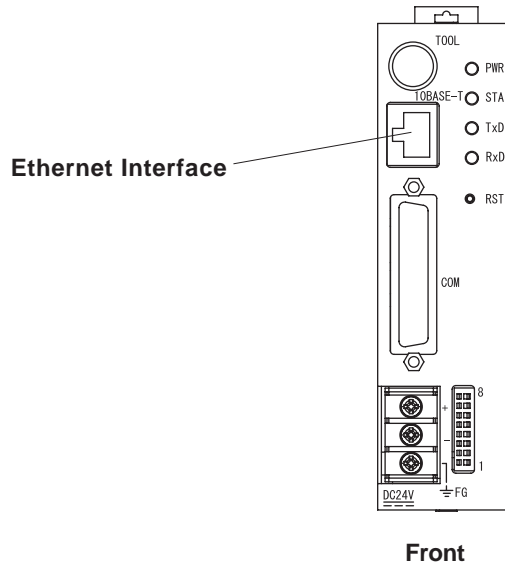

Note:

- It is strongly recommended that your Ethernet network is installed by a trained engineer.
- 1:1 connections using a cross cable may not be possible depending on the type of personal computer and network card you are using. Make sure to use a hub for connection.

3.5 IP Address Settings

To set the Factory Gateway unit's IP address, the 8 side face rotary switches are used. To set these switches, you must first remove the right face Rotary Switch Cover. The factory settings are all "0".

Also, the Factory Gateway unit's IP address is set using HEX.

The example below uses an IP address (DEC) of 192.168.0.1.

IP Address				
Decimal	192	168	0	1
Hexadecimal	C0	A8	00	01
Rotary Switch Settings				



Note:

Be sure to enter all IP address settings prior to connecting the Factory Gateway unit to the power supply. If power is connected to the Factory Gateway unit prior to setting these switches, a communication (2-Way feature) error will occur. In this case, please disconnect the Factory Gateway unit's power supply, set these switches, and reconnect the power supply.

Chapter 3 – Installation and Wiring



- The “Subnet Mask” and “Default Gateway” settings are not set via these switches. They are set using the Pro-Server with Pro-Studio for Windows software and then sent to the Factory Gateway unit.

Reference See *Pro-Server with Pro-Studio for Windows Operation Manual*.

- The IP Addresses should be set as follows:
 00.00.00.01 -> 7F.FF.FF.FE (0.0.0.1 to 127.255.255.254)
 80.00.00.01 -> BF.FF.FF.FE (128.0.0.1 to 191.255.255.254)
 C0.00.00.01 -> DF.FF.FF.FE (192.0.0.1 to 223.255.255.254)
- After setting the IP Addresses, be sure to reattach the cover.

3.6 Dip Switch Settings

The Factory Gateway unit’s Dip Switches are used to set the following features:

- Startup Transfer Mode
- Initialize Internal Memory
- Enable System Data Overwrite
- Enable 2-Way Driver Overwrite

The switches are numbered from one to eight, from bottom to top. Factory settings are OFF.

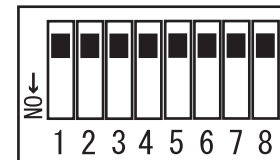

Switch No.	Feature	ON	OFF	Note
1	Reserved	——	——	Normally OFF
2	Reserved	——	——	Normally OFF
3	Startup transfer mode ^{*1}	Startup in transfer mode	Startup in on-line mode	Normally OFF
4	Initialize internal memory ^{*2}	Initialize internal memory at start up	Do NOT initialize memory at start up	Normally OFF
5	Enable System Data Overwrite ^{*3}	Overwrite Enabled	Overwrite Disabled	Normally OFF
6	Enable 2-Way Driver Overwrite ^{*3}	Overwrite Enabled	Overwrite Disabled	Normally OFF
7	Reserved	——	——	Normally OFF
8	Reserved	——	——	Normally OFF

**1 Normally, the Factory Gateway automatically changes to transfer mode. To disable this, use DIP switch NO.1. Also, be sure to set the switch back to OFF after data transfer is completed. (If the PWR LED has changed to orange, the unit has changed to transfer mode.)*

**2 Normally, the Factory Gateway reboots the system after data transfer. If Switch No.4 is left ON, every time the Factory Gateway transfers data, internal memory’s data will be initialized (deleted). After you finish using Switch No.4, be sure to set the switch to OFF before transferring data again.*

**3 The System and the 2-Way Driver data can only be overwritten using GP-PRO/PBIII for Windows.*



- **DIP switches are used to help the Factory Gateway recover from errors. Turning a switch ON forces that switch's feature, such as initializing internal memory, ON. To ensure the integrity of your data, please keep these switches OFF when they are not being used.**
- **When changing the Dip Switches, be sure the tool/item you use is insulated, to prevent accidental damage to the unit.**

3.6.1 Initializing Memory

Use the following steps to initialize the Factory Gateway unit's memory.

1. Turn the Factory Gateway unit's power supply OFF.
2. Set dipswitch 4 to ON.
3. Turn the Factory Gateway unit's power supply ON.
4. The Factory Gateway unit's power (PWR) LED will change from green to red. (approximately 10 seconds is required for initialization.)
5. The Factory Gateway unit's power (PWR) LED will change from red to green.
6. After checking that the Factory Gateway unit's power (PWR) LED has changed to orange, turn the Factory Gateway unit's power supply OFF.
7. Set dipswitch 4 to OFF.
8. Turn the Factory Gateway unit's power supply ON.

Dip Switch 4's initialization can be used for Ethernet-related information (Serial communication settings, Sub-net mask, distribution data, etc.), Network Project data, and screen data. System program, 2-Way Driver, and PLC communication protocol data cannot be initialized.

Memo



Chapter

4 Troubleshooting

1. Troubleshooting
2. Periodic Inspection

4.1 Troubleshooting

The following information explains how to troubleshoot the Factory Gateway unit. The first steps should always be to check the following items.

- Is the Factory Gateway receiving the correct level of power?
- Is the Device/PLC receiving the correct level of power?
- Is the Factory Gateway correctly connected to the Device/PLC?
- Is the Factory Gateway unit's current protocol data correct for the type of Device/PLC that is connected?

For details about the Factory Gateway Configuration Tool Error Messages, refer to the Factory Gateway Configuration Tool Operation Manual.

Reference *Factory Gateway Configuration Tool Operation Manual*

Chapter 4 – Troubleshooting

4.1.1 LED Status Indicators

The Factory Gateway unit uses two LED indicators (PWR and STA) to display the status of the Factory Gateway unit. The following table describes the problems indicated by these LEDs, and gives suggestions for how to solve each problem.

Lamp Name		Problem/Condition	Possible Solution(s)
PWR	STA		
OFF	OFF	No power	Power supply is not operating.
			Power terminal are not connected.
			Power cord is cut or damaged.
	Green	Normally OFF	If lit, a hardware error has occurred.
	Red	Normally OFF	If lit, a hardware error has occurred.
Orange	Normally OFF	If lit, a hardware error has occurred.	
Green	OFF	System Program Error	Next, turn dipswitches 5 and 6 ON and perform forced setup using GP-PRO/PBIII for Windows. Be sure to also send 2-Way Driver data.
	Green	No problem	(Normal status)
	Red	System Error/ Screen Data Memory Error (ONLINE)	Turn Dip Switch #4 ON and restart the unit. After memory is initialized, turn dip switch 4 OFF. Next, turn dipswitches 5 and 6 ON and perform forced setup using GP-PRO/PBIII for Windows. Be sure to also send 2-Way Driver data.
		Error (from external source)	Possibly interference or static from power line or input line noise. Either separate these lines, or ground the unit's FG terminal according to your country's regulations.
		Factory Gateway Error	If lit, a hardware error has occurred.
	Orange	Incorrect IP Address	Correct the unit's current rotary switch IP Address settings.
		Sub-net Mask Error	Check the unit's rotary switch IP Address settings and the Network Project's Sub-net Mask settings.
		2-Way Error	Check is there is a problem with the Network Project's Provider information.
		2-Way Driver Error	Turn Dip Switch #4 ON and restart the unit. After memory is initialized, turn dip switch 4 OFF. Next, turn dipswitches 5 and 6 ON and perform forced setup using GP-PRO/PBIII for Windows. Be sure to also send 2-Way Driver data.
	Red	OFF	Normally OFF
Green		Now initializing memory (normal)	After initialization is completed, PWR turns orange and STA turns green. Turn Dip Switch 4 OFF when completed.
Red		System Error/ Screen Data Memory Error (Now initializing memory)	Turn Dip Switch #4 ON and restart the unit. After memory is initialized, turn dip switch 4 OFF. Next, turn dipswitches 5 and 6 ON and perform forced setup using GP-PRO/PBIII for Windows. Be sure to also send 2-Way Driver data.
Orange		2-Way Error (Now initializing memory)	After initialization is completed, PWR turns orange and STA turns green. Turn Dip Switch 4 OFF when completed. When unit restarts, PWR and STA both turn green.

Chapter 4 – Troubleshooting

Lamp Name		Problem/Condition	Possible Solution(s)
PWR	STA		
Orange	OFF	System Program Error	Next, turn dipswitches 5 and 6 ON and perform forced setup using GP-PRO/PBIII for Windows. Be sure to also send 2-Way Driver data.
	Green	Factory Settings (customer enters only IP address)	Download Provider information and protocol data from Pro-Studio.
		Now transferring	Unit is operating normally and sending data.
	Red	Error (from external source)	Possibly interference or static from power line or input line noise. Either separate these lines, or ground the unit's FG terminal according to your country's regulations.
		System Error/ Screen Data Memory Error (Data transfer error)	Turn Dip Switch #4 ON and restart the unit. After memory is initialized, turn dip switch 4 OFF. Next, turn dipswitches 5 and 6 ON and perform forced setup using GP-PRO/PBIII for Windows. Be sure to also send 2-Way Driver data.
		Factory Gateway Error	Possible hardware error.
	Orange	Factory Settings (customer has not entered IP address)	IP Address has not yet been entered. Set this data via the unit's side-face rotary switches. After unit is restarted, PWR turns orange and STA turns green.
		Incorrect IP Address	Correct the unit's current rotary switch IP Address settings.
		Sub-net Mask Error	Check the unit's rotary switch IP Address settings and the Network Project's Sub-net Mask settings.
		2-Way Driver Error	Turn Dip Switch #4 ON and restart the unit. After memory is initialized, turn dip switch 4 OFF. Next, turn dipswitches 5 and 6 ON and perform forced setup using GP-PRO/PBIII for Windows. Be sure to also send 2-Way Driver data.



When a hardware error occurs, please contact your local Pro-face distributor for service and repair.

Chapter 4 – Troubleshooting

4.1.2 Problem Solving

The following data explains possible solutions for Factory Gateway unit related problems.

■ **Connecting power causes the unit to initialize memory (PWR LED red -> orange)**

CAUSE: Dip Switch #4 is turned ON.

SOLUTION: Turn Dip Switch #4 OFF and restart the Factory Gateway unit.

■ **Unable to Transfer Data**

CAUSE 1: Dip Switch #3 is turned ON, setting the unit in transfer mode.

SOLUTION: Turn Dip Switch #3 OFF and restart the Factory Gateway unit.

CAUSE 2: The protocol transferred to the Factory Gateway unit is incorrect.

SOLUTION: Check the Pro-Studio Status Monitor to confirm the type of PLC the Factory Gateway is connected to. Send new protocol if necessary.

CAUSE 3: The Ethernet type's protocol has been sent.

SOLUTION: The Factory Gateway is not designed to work with the Ethernet protocol. Send the correct protocol to the Factory Gateway from the GP-PRO/PBIII for Windows software, using the forced setup.

CAUSE 4: The Subnet Mask and the Default Gateway have been initialized.

SOLUTION: When Dip Switch #4 is used to initialize the unit, the Subnet Mask and the Default Gateway are also initialized. To use these items again, resend that data from Pro-Studio.

For information about the Sub-net Mask and the default Factory Gateway settings, refer to

Factory Gateway Configuration Tool Operation Manual

Also, the port number will revert to 8000 after initialization. Thus, if the Factory Gateway unit tries to use a port other than 8000, data transfer cannot be performed.

(Use of Port No. 8000 is recommended.)

■ GP-Viewer Screens Cannot be Displayed

CAUSE: When data is sent from the Factory Gateway Configuration Tool, screen data is deleted.

SOLUTION: GP-Viewer screen data includes protocol data as well. However, if the Factory Gateway Configuration Tool software is used to change the Factory Gateway unit's protocol, the new protocol in the Factory Gateway unit will be different from the previous protocol. To prevent a possible data/protocol type conflict, however, the Factory Gateway Configuration Tool automatically deletes all existing Factory Gateway screen data prior to sending a new protocol. This, however, means that there is now no data for GP-Viewer to read out and display.

To prevent this type of problem, when using Pro-Viewer to view Factory Gateway data be sure to always use GP-PRO/PRIII to send both screen and protocol data to the Factory Gateway unit.

4.2 Periodic Check Points

To keep your Factory Gateway unit in its best condition, inspect the following points periodically.

Operation Environment

- Is the operating temperature within the allowable range (0° C to 55° C)?
- Is the operating humidity within the specified range (10%RH to 90%RH, wet bulb temperature of 39° C or less)?
- Is the operating atmosphere free of corrosive gasses?

Electrical Specifications

- Is the input voltage (DC 19.2V to DC 28.8V) appropriate?

Related Items

- Are all power cords and cables connected properly? Have any become loose?
- Is the DIN rail holding the unit securely?

Memo